

3907887



Portable 20 Gallon Parts Washer Assembly & Operating Instructions



READ ALL INSTRUCTIONS AND WARNINGS BEFORE USING THIS PRODUCT.

This manual provides important information on proper operation & maintenance. Every effort has been made to ensure the accuracy of this manual. These instructions are not meant to cover every possible condition and situation that may occur. **We reserve the right to change this product at any time without prior notice.**

IF THERE IS ANY QUESTION ABOUT A CONDITION BEING SAFE OR UNSAFE, DO NOT OPERATE THIS PRODUCT!

HAVE QUESTIONS OR PROBLEMS? DO NOT RETURN THIS PRODUCT TO THE RETAILER - CONTACT CUSTOMER SERVICE.

If you experience a problem or need parts for this product, visit our website <http://www.buffalotools.com> or call our customer help line at 1-888-287-6981, Monday-Friday, 8 AM - 4 PM Central Time. A copy of the sales receipt is required.

FOR CONSUMER USE ONLY – NOT FOR PROFESSIONAL USE.

KEEP THIS MANUAL, SALES RECEIPT & APPLICABLE WARRANTY FOR FUTURE REFERENCE.

TABLE OF CONTENTS

RECOGNIZE SAFETY SYMBOLS, WORDS AND LABELS.....2

SERVICE.....6

SPECIFIC SAFETY RULES AND/OR SYMBOLS6

PACKAGE CONTENTS7

COMPONENTS.....7

ASSEMBLY.....8

OPERATION9

MAINTENANCE9

ACCESSORIES10

PARTS DIAGRAM.....11

PARTS LIST.....11

RECOGNIZE SAFETY SYMBOLS, WORDS AND LABELS

What You Need to Know About Safety Instructions

Warning and Important Safety Instructions appearing in this manual are not meant to cover all possible conditions and situations that may occur. Common sense, caution and care must be exercised when assembling or using this product.

Always contact your dealer, distributor, service agent or manufacturer about problems or conditions you do not understand.

 WARNING This is a safety alert symbol. It is used to alert you to potential personal injury hazards. Obey all safety messages that follow this symbol to avoid possible injury or death.

 CAUTION This is a safety alert symbol. It is used to alert you to potential personal injury hazards. Obey all safety messages that follow this symbol to avoid possible injury or death.

GENERAL PRODUCT SPECIFICATIONS



FEATURES:

- 20 Gallon Tank Capacity / 12 Gallon Solvent Capacity
- Red Powder Coat Paint Finish / Heavy-Duty Steel Construction
- 120 Volts / 60 Hz Water Pump
- Fusible Link Arm & Steel Lid
- Max. Pump Output: 192 GPH flow rate (with flexible pipe)
- Max. Pump Output: 318 GPH flow rate (without flexible pipe)
- Recirculates 2.6-3.2 GPM of Solvent
- Flexible Chrome Plated Nozzle Adjusts For Full Coverage



SPECIFICATIONS

- Rated Voltage 120V / 60 Hz
- Overall Dimensions: L x W x H 29 15/16" x 21 1/4" x 34 5/8"
- Tank Dimensions: L x W x H 31 1/8" x 21 5/8" x 12 19/32"
- Max Output Through Spigot: 2.64-3.1 Gallons/min

KEEP THIS MANUAL, SALES RECEIPT & APPLICABLE WARRANTY FOR FUTURE REFERENCE.

READ ALL INSTRUCTIONS AND WARNINGS BEFORE USING THIS PRODUCT. When unpacking, check to make sure all parts listed are included. If any parts are missing or broken, please call Customer Service at 1-888-287-6981.

FOR CONSUMER USE ONLY – NOT FOR PROFESSIONAL USE

IMPORTANT SAFETY RULES

COMMON SENSE AND CAUTION ARE FACTORS WHICH CANNOT BE BUILT INTO ANY PRODUCT. THESE FACTORS MUST BE SUPPLIED BY THE OPERATOR.

WARNING

Keep your work area clean and well lit. Cluttered work benches and dark work areas may cause accidents or injury.

Do not operate the parts washer in explosive areas, such as in the presence of flammable liquids, gases or dust. Power tools create sparks which may ignite the dust or fumes.

Keep bystanders, children and visitors away while operating the parts washer. Distractions can cause you to lose control.

WARNING

Double insulated tools are equipped with a polarized plug (one blade is wider than the other.) This plug will fit in a polarized outlet only one way. If the plug does not fit fully in the outlet, reverse the plug. If it still does not fit, contact a qualified electrician to install a polarized outlet. Do not change the plug in any way. Double insulation eliminates the need for the three wire grounded power cord and grounded power supply system.

Avoid body contact with grounded surfaces such as pipes, radiators, ranges and refrigerators. There is an increased risk of electric shock if your body is grounded.

Do not abuse the cord. Never use the cord to carry the tool or pull the plug from an outlet. Keep the cord away from heat, oil, sharp edges, or moving parts. Replace damaged cords immediately. Damaged cords increase the risk of electric shock.

When operating the tool outside, use an outdoor extension cord marked “WA” or “W.” These cords are rated for outdoor use and reduce the risk of electric shock. Make sure the extension cord being used is in good condition. If there are any cuts or nicks (no matter how deep) in the insulation, DO NOT use that cord. Also, make sure the extension cord is heavy enough to carry the current needed. DO NOT use small "around-the-house" lamp extension cords. These cords can easily overheat and/or catch fire when used with power tools.

CAUTION

Do not force tool. Use the correct tool for your application. The correct tool will do the job better and safer at the rate for which it is designed.

Do not use the parts washer if the power switch does not turn it “ON” or “OFF”. Any tool that cannot be controlled with the switch is dangerous and must be repaired.

Disconnect the power cord plug from the power source before making any adjustments, changing accessories or storing the tool. Such preventive safety measures reduce the risk of starting the tool accidentally.

Store idle tools out of reach of children and other untrained persons. Tools are dangerous in the hands of untrained users.

⚠ DANGER

Clean off any accidental splashes of degreaser on skin immediately, following the degreaser manufacturer's instructions carefully. Seek medical attention if necessary.

⚠ WARNING

Wash hands after handling the power cord. Touching the power cord could expose you to lead, which is known in the State of California to cause cancer, birth defects and other reproductive harm.

⚠ WARNING

All work areas should be clean and well lit. Accidents are more likely to occur in poorly lit and cluttered areas.

⚠ WARNING

The pump of your parts washer may be damaged if you use solvents other than those listed.

⚠ WARNING

Keep the power cord in good condition, and replace damaged cords immediately. Do not use the cord to pull the plug from the outlet. Keep the cord away from materials and surfaces that could damage cords. The risk of electric shock increases when the power cord is damaged.

⚠ WARNING

Always use the appropriate extension cord, making sure it is rated for use with parts washer. Always be sure the extension cords are in good condition, free of cuts or nicks in the insulation. If using the power tool in an outside area with an extension cord, make sure the cord is rated for outdoor use.

⚠ WARNING

Do not make contact with a grounded surface while using this parts washer. Contact with surfaces like pipes, radiators or major appliances increases your risk of electric shock.

⚠ WARNING

Use common sense while operating this parts washer.

Do not use this tool if you are:

- Feeling tired or are under the influence of alcohol or drugs.
- Wearing loose clothing or jewelry. Keep long hair pulled back and away from moving parts.
- Overreaching or have improper footing. Handling the tool in this way could cause serious injury.
- When using this parts washer, always:
 - Wear the proper safety equipment, such as safety goggles, dust masks, non-skid shoes, etc.
 - Check to be sure all adjusting keys or wrenches have been removed before starting the power tool.
 - Check that the power switch is in the "OFF" position before plugging the unit into an electrical outlet.

⚠ CAUTION

Follow these steps to maintain safe working conditions and good working condition of power tools. Improper care can result in electric shock or serious injury.

Secure and support the work piece using clamps. **Do not use your hands to hold the piece in place.**

Use the correct tool for the job. Using the correct tool is safer and faster.

Make sure the power switch is in good working order. If the power switch no longer turns the tool “ON” or “OFF”, discontinue use, and have the tool replaced or repaired.

Remove the power cord from the power source before storage, changing accessories, or moving.

Keep out of reach of children, or any untrained person. Store tools in a safe and dry place.

Keep tools clean, and cutting tools sharp. Maintaining tools with proper care will increase the life of the power tool, and reduce the risk of injury.

Check to be sure all moving parts are free from binding and are properly aligned.

Use only accessories that are recommended by the manufacturer for your tool model.

⚠ WARNING

Safety glasses and ear protection must be worn during operation.

Never use items to support the lid.

Use water based solvents only in the Parts Washer. These solvents have a PH of more than 7.

SERVICE

Tool service must be performed only by qualified repair personnel. Service or maintenance by unqualified personnel could result in a risk of injury.

When servicing a tool, use only identical replacement parts and follow instructions in the manual. Use of unauthorized parts or failure to follow Maintenance Instructions may create a risk of shock or injury.

SAVE THESE INSTRUCTIONS FOR FUTURE REFERENCE.

This manual contains important information regarding safety, operation, maintenance and storage of this product. Before use, read carefully and understand all warnings, cautions, instructions and labels. Failure to do so could result in serious personal injury, property damage or even death.

IMPORTANT SAFETY INSTRUCTIONS





⚠ WARNING

Before using this tool, you need to become familiar with its operation. If you are unsure about the operation of the tool, or have any questions about its proper use, call the Customer Service Department at 1-888-287-6981. Follow these instructions for safe handling of the tool:

- **Always secure and support the work piece using clamps. Do not use your hands to hold the piece in place.**
- **Be sure your work area is clean and secure before turning the power switch into the “ON” position.** Be sure the area is free from all foreign material, nails, staples, or any other material.
- **Turn the Parts Washer “OFF” and unplug from the power source before making any changes or adjustments.**
- **Do not use solvents containing carbon tetrachloride, ammonia or acetone to clean the unit.** Never use gasoline, paint thinner, or other caustic chemicals that can damage the unit.
- **Always use the appropriate safety gear when operating this parts washer.** Including but not limited, to goggles, dust mask or respirator. Always work in a well-ventilated area to reduce your exposure to harmful chemicals and dust particles.
- **Keep hands away from the cutting area.**
- **Do not reach under the work piece.**

SPECIFIC SAFETY RULES AND/OR SYMBOLS

The following symbols may be used on your tool. Be familiar with and learn the symbols to operate the tool safely.

Symbol	Name	Description
V	Volts	Voltage (Potential)
A	Amperes	Current
Hz	Hertz	Frequency (Cycles per Second)
W	Watt	Power
Kg	Kilograms	Weight
	Alternating Current	Type of Current
	Direct Current	Type of Current
	Alternating or Direct Current	Type of Current
	Earthing Terminal	Grounding Terminal
	Class II Construction	Denotes Double Insulation
min	Minutes	Time
s	Seconds	Time
ϕ	Diameter	Size of Drill Bits, Grinding Wheels, etc.
n_0	No Load Speed	No-load Rotational Speed
.../min	Revolutions per Minute	Revolutions, Surface Speed, Strokes, etc. per Minute
1,2,3...	Ring Selector Settings	Speed, Torque or Position Settings

PACKAGE CONTENTS

- Parts Washer
- Four Support Legs
- Shelf

COMPONENTS



- 1) Lid
- 2) Fusible Link
- 3) Flexible Pipe
- 4) Power Switch
- 5) Tank
- 6) Shelf
- 7) Leg
- 8) Drainage Container

ASSEMBLY

WARNING

Do not turn the power switch on until the Parts Washer has been completely assembled. Failure to do so could result in serious injury or electric shock.

NOTE

Unpack product from package and review contents. Keep all packaging until product has been reviewed.

Lower Shelf

1. Locate the two Handles and the Lower Shelf.
 2. Align the holes in the bottom of the Handles with the 4 holes in the corners of the Lower Shelf.
 3. Place Flat Washer onto Bolt and insert Bolt through Handle and Lower Shelf.
 4. Place Flat Washer and Lock Nut onto end of Bolt and hand tighten.
 5. Repeat steps 3-4 for remaining holes in Lower Shelf.
- Note: Do not fully tighten nuts at this time.

Middle (Parts Drying) Shelf

1. Locate the Middle Shelf and the Tank Drain.
 2. Insert the Tank Drain into the slots located in the bottom of Middle Shelf.
 3. Align the holes in the 4 corners of the Middle Shelf with the holes in the middle of the Handles.
 4. Place Lock Washer onto Bolt and insert Bolt through Handle and Middle Shelf.
 5. Thread end of Bolt into the nut welded on inner wall of Middle Shelf and hand tighten.
 6. Repeat steps 4-5 for remaining holes in Middle Shelf.
- Note: Do not fully tighten nuts at this time.

Tank Mounts

1. Locate the Left Tank Mount and Right Tank Mount.
- Note: Right Tank Mount has hooks for electrical cord storage.
2. Align the holes in the Left Tank Mount with the uppermost holes in either Handle.
 3. Place Flat Washer onto Bolt and insert Bolt through Handle and Left Tank Mount.
 4. Place Flat Washer and Lock Nut onto end of Bolt and hand tighten.
 5. Repeat steps 3-4 for remaining hole in Left Tank Mount.
 6. Align the holes in the Right Tank Mount with the holes in the remaining Handle. Hooks on Right Tank Mount should be facing AWAY from center on unit.
 7. Follow steps 3-5 to install Right Tank Mount.
- Note: Do not fully tighten nuts at this time.

Tank

Note: You may need a second person to help properly align the Tank to the Tank Mounts.

1. Place Flat Washer onto Short Bolt and insert through hole in Tank Mount.
2. Place Adjusting Washer onto Short Bolt.
3. Slide the end of the Short Bolt through the hole in the mounting bracket on Tank bottom.
4. Place Flat Washer and Lock Nut onto end of Short Bolt and hand tighten.
5. Repeat steps 1-4 for remaining seven holes in Tank Mounts. Note: The Power Switch is on the RIGHT side of the Tank and should be positioned above the RIGHT Tank Mount.

Tightening the Hardware

1. Fully tighten all of the Lock Nuts onto the bolts which were installed in the previous section.

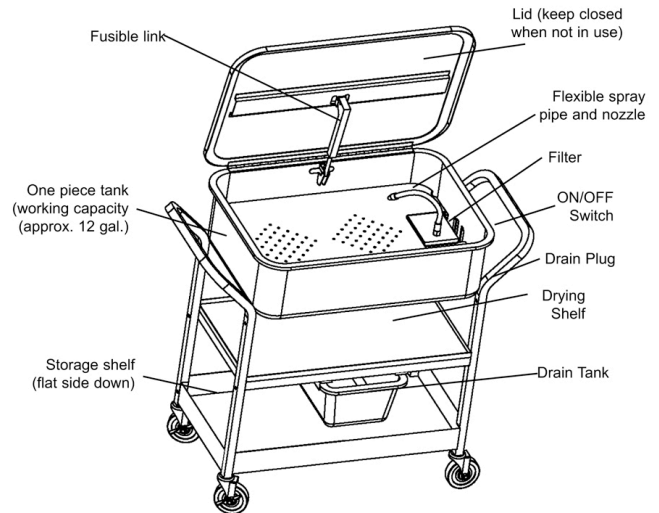

Mounting the Pump

1. Align the slots on the rear of the Pump Housing with the tabs on the inner right side of the Tank.
2. Carefully slide the Pump Housing slots onto the tabs of the Tank.
3. Lower Pump Housing until it is resting on the Tank bottom.

Washboard

1. Position the Washboard so that the lipped edges are facing down and the rectangular cutout is on the right side.
2. Place your index fingers through the holes located at the front left and right rear of the Washboard.
3. Align the lipped edges of Washboard with the mounting brackets on inner Tank walls and gently lower into place.

Castors

1. Locate the four Castors and the four Spring Washers.
2. Place a Spring Washer onto the threaded end of Castor.
3. Insert Castor threads into hole on bottom of Handle.
4. Tighten Castor in place with wrench.

OPERATION

⚠ CAUTION

Do not use volatile, flammable or combustible solvents, or fuels such as gasoline, diesel, or toluene. Use only non-corrosive water based solvents.

⚠ WARNING

The pump must be immersed in liquid while operating. Fluid should be replaced and the Parts Washer cleaned on a regular basis to avoid hazardous conditions.

⚠ WARNING

Chlorinated solvents such as 1-1-1 Trichloroethane and Methylene Chloride (also known as Methyl Chloride) can chemically react with aluminum and may explode. Many tools and pieces of equipment contain aluminum.

Fill the body with the cleaning solution, to just below the horizontal crease on the body.

Lift the cover, placing the items to be cleaned onto the shelf.

Plug the power cord into a power source. Turn the power switch ON.

When the tool is cleaned, turn the power switch OFF, and unplug from the power source.

Do not allow the level of liquid in the parts washer to fall below the pump inlet, as damage to the pump can result.

Change degreaser as needed. Tank can be drained by removing the Drain Plug on bottom of Tank.

MAINTENANCE

⚠ WARNING

Disconnect the power supply before cleaning. Wear safety eyewear before cleaning.

CAUTION

A qualified repair technician must perform any tool service or repair. Service or maintenance performed by unqualified personnel could result in injury. Use only identical replacement parts. Use of unauthorized parts or failure to follow maintenance instructions may create a risk of electric shock or injury.

⚠ WARNING

Do not make contact with a grounded surface while using this power tool. Contact with surfaces like pipes, radiators or major appliances increase your risk of electric shock.

Warning: Always unplug the Power Cord from the electrical outlet before performing any maintenance.

Replacing Cleaning Solution

1. Replace the cleaning solution when it becomes dirty.
2. Place an empty container on the lower Shelf that is large enough to hold all of the liquid which is in the Body.
3. Remove the Plug from the bottom of the Body. The fluid should drain into the empty container on the Shelf below.
4. Dispose of the used cleaning solution properly. Do not drain the cleaning solution into the street drains, house drains, or into the earth. Contact your local waste management officials for proper disposal methods.
5. Replace the Plug then refill the Body with new cleaning solution.

When the cleaning solution flow is reduced or stopped, it may be necessary to clean the Flexible Pipe.

Cleaning the Flexible Pipe and Impeller

1. Make certain that the indicator light on the Switch Box is on.
2. Turn the Switch to the OFF position.
3. Unplug the Power Cord from the electrical outlet.
4. Remove the Flexible Pipe from the Elbow. Drain the pipe, inspect its interior for debris. Use compressed air to blow clean.
5. Remove the Pump Housing Cover by removing the Screws, then clear and remove any foreign matter from the impeller.
6. Reattach the Flexible Pipe to the Elbow, and replace the Pump Housing Cover.

ACCESSORIES

Use only accessories that are recommended by the manufacturer for your model. Accessories that may be suitable for one tool may become hazardous when used on another tool.

Always attach grounded (3-prong) extension cords to grounded (3-prong) outlets.

If you must use an extension cord, be sure that the gauge is large enough to carry the amount of current necessary for your power tool. If not, your tool may experience a loss of power, excessive voltage drop or overheating. For example, the smaller the gauge number, the heavier the cord.

PARTS DIAGRAM

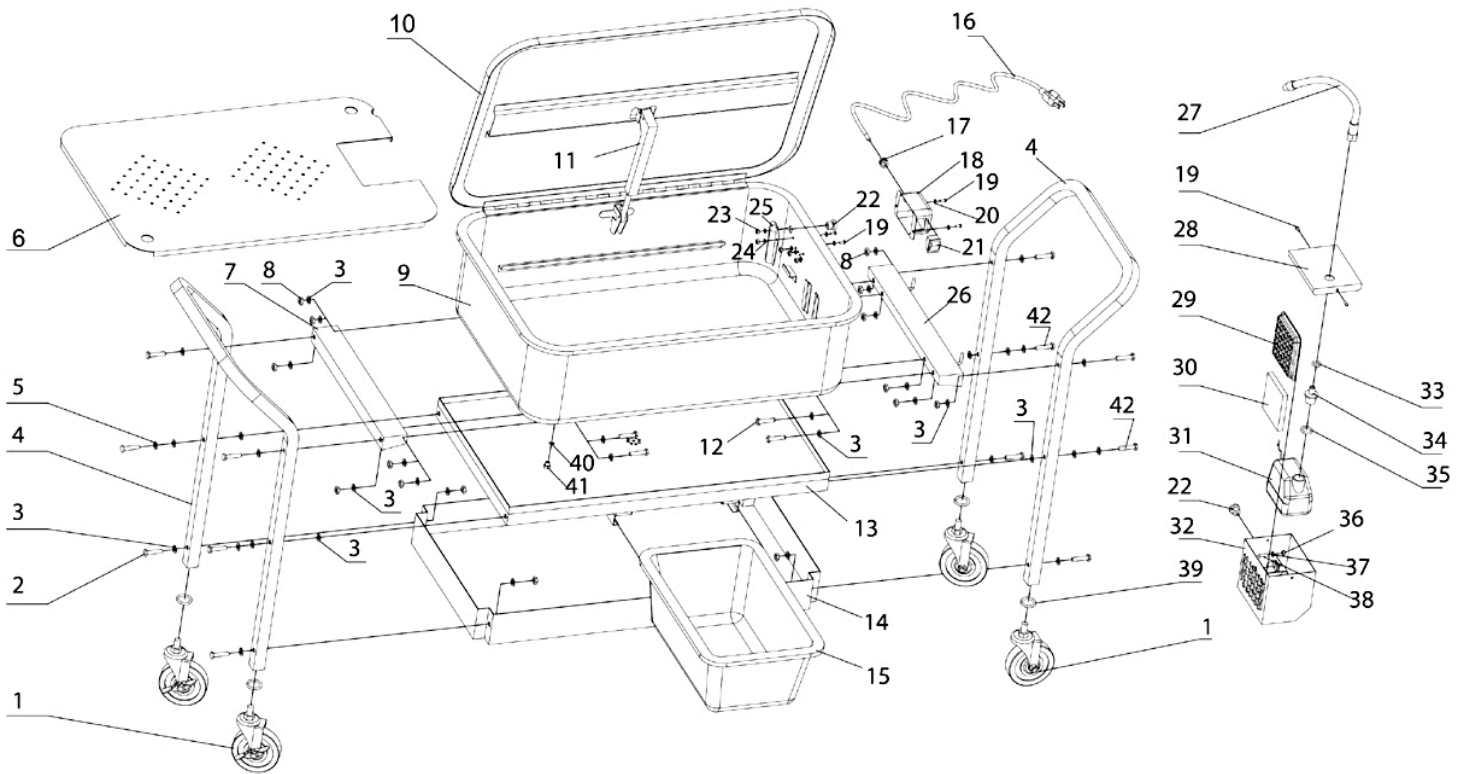

PARTS LIST

#	Description	Qty	#	Description	Qty
1	Castor	4	22	Cable Guard	2
2	Bolt	8	23	Hex Nut M4	5
3	Flat Washer	40	24	Spring Washer	5
4	Handle	2	25	Wire Flange	1
5	Lock Washer	4	26	Right Tank Mount	1
6	Washboard	1	27	Flexible Nozzle	1
7	Left Tank Mount	1	28	Pump Housing Cover	1
8	Lock Nut	16	29	Filter Cover	1
9	Tank	1	30	Filter Screen	1
10	Tank Lid	1	31	Pump Assembly	1
11	Fusible Link	1	32	Pump Housing	1
12	Short Bolt	8	33	Grommet	1
13	Middle Shelf	1	34	Spigot	1
14	Lower Shelf	1	35	Grommet	1
15	Drain Tank	1	36	Hex Nut M5	1
16	Power Cord	1	37	Flat Washer	1
17	Cable Clamp	1	38	Screw M5X20	1
18	Switch Box	1	39	Spring Washer	4
19	Screw	7	40	Grommet	1
20	Flat Washer M4	7	41	Plug	1
21	Power Switch	1	42	Bolt	4

NOTES:

