

Processes



Oxy-Fuel Welding and Cutting

Description



Accessory

Medium-Duty Oxy-Acetylene Cutting and Welding Outfit 770 502



OWNER'S MANUAL



TABLE OF CONTENTS

SECTION 1 – SAFETY PRECAUTIONS - READ BEFORE USING	1
1-1. Symbol Usage	1
1-2. Welding, Cutting, Brazing, And Heating Hazards	1
1-3. California Proposition 65 Warnings	3
1-4. Principal Safety Standards	3
SECTION 2 – INTRODUCTION	4
SECTION 3 – HAZARDOUS EVENTS	4
SECTION 4 – ASSOCIATED HAZARDS OF RECOMPRESSING PURE OXYGEN	4
SECTION 5 – SPECIFICATIONS	5
5-1. Equipment Included With The Kit	5
5-2. Specifications	5
5-3. Welding (Brazing) Tip And Gas Pressure Guide	5
5-4. Cutting Tip And Gas Pressure Guide	5
5-5. Victor-Compatible Components	6
SECTION 6 – INSTALLATION	7
6-1. Installing Cylinders	7
6-2. Installing Regulators On Cylinders	8
6-3. Installing Hoses On Regulators	9
6-4. Attaching Hoses To Torch Flashback Arrestors/Check Valves	10
6-5. Attaching Cutting Attachment To Torch Handle	10
6-6. Installing Cutting Tip On Cutting Attachment	11
6-7. Attaching Welding/Brazing Tip To Torch Handle	11
6-8. Testing The System For Leaks	12
SECTION 7 – OPERATION	13
7-1. Purging Oxygen From The System And Adjusting Oxygen Pressure	13
7-2. Purging Fuel From The System And Adjusting Fuel Pressure	14
7-3. Lighting And Using The Cutting Torch	15
7-4. Lighting And Using The Brazing Tip	16

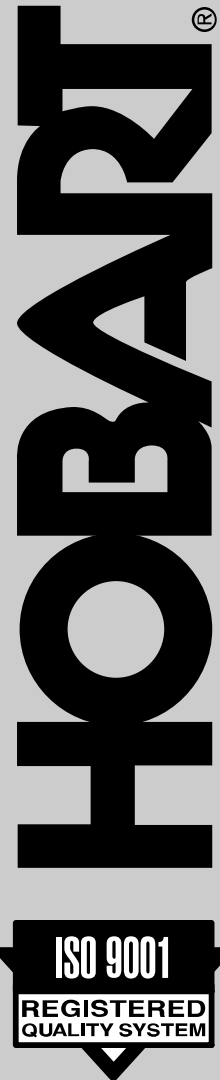

Hobart is registered to the ISO 9001 Quality System Standard.

SECTION 1 – SAFETY PRECAUTIONS - READ BEFORE USING

OXY FUEL 2013-09

 Protect yourself and others from injury — read, follow, and save these important safety precautions and operating instructions.

1-1. Symbol Usage

 **DANGER!** – Indicates a hazardous situation which, if not avoided, will result in death or serious injury. The possible hazards are shown in the adjoining symbols or explained in the text.

 Indicates a hazardous situation which, if not avoided, could result in death or serious injury. The possible hazards are shown in the adjoining symbols or explained in the text.

NOTICE – Indicates statements not related to personal injury.

 Indicates special instructions.



This group of symbols means Warning! Watch Out! ELECTRIC SHOCK, MOVING PARTS, and HOT PARTS hazards. Consult symbols and related instructions below for necessary actions to avoid the hazards.

1-2. Welding, Cutting, Brazing, And Heating Hazards

 The symbols shown below are used throughout this manual to call attention to and identify possible hazards. When you see the symbol, watch out, and follow the related instructions to avoid the hazard. The safety information given below is only a summary of the more complete safety information found in the Safety Standards listed in Section 1-4. Read and follow all Safety Standards.

 Only qualified persons should install, operate, maintain, and repair this equipment.

 During operation, keep everybody, especially children, away.

 Do not use this equipment unless you are trained in its proper use or are under competent supervision. Follow the procedures described in this booklet every time you use the equipment. Failure to follow these instructions may cause fire, explosion, asphyxiation, property damage, or personal injury. This equipment must be used in accordance with all Federal, State, and local regulations as well as DOT (Department of Transportation) and CGA (Compressed Gas Association) regulations. Contact your gas supplier for more information on the proper use of compressed gases.

 In this document, the phrase “welding and cutting” also refers to other oxy-fuel operations like brazing and heating.

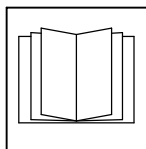

READ INSTRUCTIONS.

- Read and follow all labels and the Owner's Manual carefully before installing, operating, or servicing equipment. Read the safety information at the beginning of the manual and in each section.

- Use only genuine replacement parts from the manufacturer.
- Perform maintenance and service according to the Owner's Manuals, industry standards, and national, state, and local codes.



HOT PARTS can burn.

- Do not touch hot parts bare handed.
- Allow cooling period before working on equipment.
- To handle hot parts, use proper tools and/or wear heavy, insulated welding gloves and clothing to prevent burns.

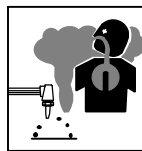

FUMES AND GASES can be hazardous.

Welding and cutting produces fumes and gases. Breathing these fumes and gases can be hazardous to your health.

- Keep your head out of the fumes. Do not breathe the fumes.
- If inside, ventilate the area and/or use local forced ventilation at the flame to remove welding and cutting fumes and gases. Some gases (natural gas and acetylene) are lighter than air and will collect in high areas. Other gases (propane and butane) are heavier than air and will collect in low areas. Heavier-than-air gases are more difficult to diffuse and are more likely to accumulate. The recommended way to determine adequate ventilation is to sample for the composition and quantity of fumes and gases to which personnel are exposed.
- If ventilation is poor, wear an approved air-supplied respirator.
- Read and understand the Safety Data Sheets (SDSs) and the manufacturer's instructions for adhesives, coatings, cleaners, consumables, coolants, degreasers, fluxes, and metals.
- Work in a confined space only if it is well ventilated, or while wearing an air-supplied respirator. Always have a trained watchperson nearby. Welding and cutting fumes and gases can displace air and lower the oxygen level, causing injury or death. Be sure the breathing air is safe. Test atmospheres in confined spaces for explosive and toxic gases before using oxy-fuel equipment.
- Do not weld or cut in locations near degreasing, cleaning, or spraying operations. The heat from welding or cutting flame can react with vapors to form highly toxic and irritating gases.
- Do not weld or cut on coated metals, such as galvanized, lead, or cadmium-plated steel unless the coating is removed from the affected area, the area is well ventilated, and while wearing an air-supplied respirator. The coatings and any metals containing these elements can give off toxic fumes if welded or cut.
- Do not weld or cut on sealed air conditioning or refrigeration systems unless all refrigerants have been removed from the system.



LIGHT RAYS can burn eyes and skin.

Light rays from the welding and cutting process produce intense visible and invisible (ultraviolet and infrared) rays that can burn eyes and skin. Sparks fly off from the weld.

- Wear approved face protection fitted with a proper shade of filter lenses to protect your face and eyes from light rays and sparks when welding, cutting, or watching (see ANSI Z49.1 and Z87.1 listed in Safety Standards).
- Wear welding goggles, or wear welding helmet/welding faceshield over approved goggles/safety glasses with side shields.
- Use protective screens or barriers to protect others from flash, glare and sparks; warn others not to watch the welding or cutting.
- Wear body protection made from durable, flame-resistant material (leather, heavy cotton, wool). Body protection includes oil-free clothing such as leather gloves, heavy shirt, cuffless trousers, high shoes, and a cap.



WELDING AND CUTTING can cause fire or explosion.

Welding and cutting on closed containers, such as tanks, drums, or pipes, can cause them to blow up. Sparks can fly off from the welding or cutting operations. The flying sparks, hot workpiece, and hot

equipment can cause fires and burns. Check and be sure the area is safe before doing any welding or cutting.

- Do not use this welding and cutting equipment with gases and pressures other than those for which it is intended. Oxygen is not flammable; however, the presence of pure oxygen will drastically increase the speed and force with which burning takes place. Oxygen must never be allowed to contact grease, oil, or other petroleum-based substances; therefore, be sure there is no oil or grease on the regulator, cylinder, valves, or equipment. Do not use petroleum-based pipe sealants. Do not use or store near excessive heat (above 125° F/51.5° C) or open flame. Do not refer to oxygen as air and do not use oxygen as a substitute for compressed air. Do not use oxygen to clean clothes or work area, for ventilation, or to operate pneumatic tools. Open oxygen cylinder valves slowly. Be sure regulator adjusting handle is in the full out (off) position before opening oxygen cylinder valve.
- Inspect all equipment before use. Do not use damaged, defective, or improperly adjusted welding and cutting equipment. Make sure levers and valves work properly, threads on equipment are clean (no grease or oil) and not deformed, gauges are intact and easy to read, regulator is clean and free of oil or dirt, and fittings are properly sized for the cylinder. Make sure hoses are clean (no grease or oil) and ferrules are properly installed so the fitting does not slip inside the hose. Be sure all connections are tight.
- It is recommended that a reverse-flow check valve or a flashback arrestor be installed between the torch handle and the regulator. Check valves do not prevent the propagation of a flame upstream (flashback) but are designed to prevent the unintentional backflow of gases into the cutting attachment, torch, hoses, or regulator which could cause an explosion or fire. A flashback arrestor can be installed on the torch handle instead of a check valve. Miller flashback arrestor have a reverse flow check valve and prevent the propagation of a flame upstream. If a flashback arrestor is installed, a check valve is not necessary. Using a flashback arrestor and a check valve may reduce gas flow and affect torch operation. To help prevent the reverse flow of gases, be sure the cylinders contain enough gas to complete the work.
- Perform work only in an area with a fireproof floor (concrete). Do not heat concrete because it may expand and explode violently.
- Perform work on a fireproof surface. Use heat resistant shields to protect nearby walls and flooring.
- Do not use if grease or oil is present on equipment or if equipment is damaged. Have equipment cleaned/repared by a qualified person.
- Do not open a cylinder valve quickly or the regulator may be damaged and cause a fire.
- Do not open acetylene cylinder valve more than 3/4 turn. (For all gases except acetylene, open cylinder valve fully to backseat the cylinder valve.) Keep cylinder wrench on the cylinder for quick shut-off.
- Do not slightly open or "crack" fuel cylinder valve to blow debris from the valve outlet. Remove the debris using nitrogen, air, or a clean, oil-free rag.
- Always purge gas from the system before lighting torch. Purge gas in a well-ventilated area and away from flame or sparks.
- Keep torch flame or sparks away from cylinder, regulator, and gas hose.
- Use only the gases recommended by the manufacturer of the oxy-fuel equipment being used.
- Never light a torch with matches or a lighter. Always use a striker.
- Do not use acetylene above 15 psi (103 kPa) flowing. It is acceptable to use acetylene regulators that indicate a static pressure up to 22 psi (151 kPa).
- Check oxy-fuel system for leaks with an approved leak detection solution or leak detector. Never test for gas leaks with a flame.
- Remove all flammables within 35 ft (10.7 m) of the welding or cutting operation. If this is not possible, tightly cover them with approved covers.

- Do not weld or cut where flying sparks can strike flammable material.
- Protect yourself and others from flying sparks and hot metal.
- Be alert that welding and cutting sparks and hot materials from welding and cutting can easily go through small cracks and openings to adjacent areas.
- Watch for fire, and keep a fire extinguisher nearby.
- Be aware that welding or cutting on a ceiling, floor, bulkhead, or partition can cause fire on the hidden side.
- Do not weld or cut on containers that have held combustibles, or on closed containers such as tanks, drums, or pipes unless they are properly prepared according to AWS F4.1 and AWS A6.0 (see Safety Standards).
- Do not weld or cut where the atmosphere may contain flammable dust, gas, or liquid vapors (such as gasoline).
- Wear body protection made from durable, flame-resistant material (leather, heavy cotton, wool). Body protection includes oil-free clothing such as leather gloves, heavy shirt, cuffless trousers, high shoes, and a cap.
- Do not use fuel gases to clean clothes or work area.
- Remove any combustibles, such as a butane lighter or matches, from your person before doing any welding or cutting.
- After completion of work, inspect area to ensure it is free of sparks, glowing embers, and flames.
- Follow requirements in OSHA 1910.252 (a) (2) (iv) and NFPA 51B for hot work and have a fire watcher and extinguisher nearby.



BUILDUP OF GAS can injure or kill.

- Shut off compressed gas supply when not in use.
- Always ventilate confined spaces or use approved air-supplied respirator.

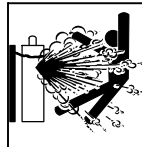

CYLINDERS can explode if damaged.

Compressed gas cylinders contain gas under high pressure. If damaged, a cylinder can explode. Since gas cylinders are normally part of the welding or cutting process, be sure to treat them carefully.

- Protect compressed gas cylinders from excessive heat, mechanical shocks, physical damage, slag, open flames, and sparks.
- Install cylinders in an upright position by securing to a stationary support or cylinder rack to prevent falling or tipping. Do not lay acetylene cylinders on their sides or acetone will flow out of the cylinder and damage the equipment.
- Keep cylinders away from any arc welding, cutting, or other electrical circuits.
- Never drape a welding or cutting torch over a gas cylinder.
- Never weld or cut on a pressurized cylinder – explosion will result.
- Use only correct compressed gas cylinders, regulators, hoses, and fittings designed for the specific application; maintain them and associated parts in good condition. Do not use compressed gas cylinder unless an approved gas regulator is attached to the gas valve.
- Turn face away from valve outlet when opening cylinder valve. Do not stand in front of or behind the regulator when opening the valve.
- Keep protective cap in place over valve except when cylinder is in use or connected for use.
- Use the right equipment, correct procedures, and sufficient number of persons to lift and move cylinders.
- Store compressed gas and oxygen cylinders in separate locations.
- Store empty cylinders with valves closed and caps in place.
- Do not modify or repair cylinders or valves. Store leaking acetylene cylinders outdoors in a safe area. Identify leaking cylinders and return them to the supplier.
- Dispose of used disposable cylinders according to the manufacturer's recommendations. Do not throw cylinders in fire.
- Follow instructions provided by the gas supplier and on compressed gas cylinders, associated equipment, and in Compressed Gas Association (CGA) publication P-1 listed in Safety Standards.

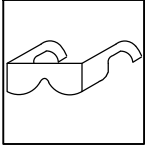

FLYING METAL or DIRT can injure eyes.

- Welding, cutting, chipping, wire brushing, and grinding cause sparks and flying metal.
- Wear welding goggles, or wear welding helmet /welding faceshield over approved goggles/ safety glasses with side shields.

1-3. California Proposition 65 Warnings

! Welding or cutting equipment produces fumes or gases which contain chemicals known to the State of California to cause birth defects and, in some cases, cancer. (California Health & Safety Code Section 25249.5 et seq.)

! This product contains chemicals, including lead, known to the state of California to cause cancer, birth defects, or other reproductive harm. *Wash hands after use.*

1-4. Principal Safety Standards

Safety in Welding, Cutting, and Allied Processes, ANSI Standard Z49.1, is available as a free download from the American Welding Society at <http://www.aws.org> or purchased from Global Engineering Documents (phone: 1-877-413-5184, website: www.global.ihs.com).

Safe Practices for the Preparation of Containers and Piping for Welding and Cutting, American Welding Society Standard AWS F4.1, from Global Engineering Documents (phone: 1-877-413-5184, website: www.global.ihs.com).

Safe Practices for Welding and Cutting Containers that have Held Combustibles, American Welding Society Standard AWS A6.0, from Global Engineering Documents (phone: 1-877-413-5184, website: www.global.ihs.com).

Safe Handling of Compressed Gases in Cylinders, CGA Pamphlet P-1, from Compressed Gas Association, 14501 George Carter Way, Suite 103, Chantilly, VA 20151 (phone: 703-788-2700, website: www.cganet.com).

Acetylene, CGA Pamphlet G-1, from Compressed Gas Association, 14501 George Carter Way, Suite 103, Chantilly, VA 20151 (phone: 703-788-2700, website: www.cganet.com).

Safety in Welding, Cutting, and Allied Processes, CSA Standard W117.2, from Canadian Standards Association, Standards Sales, 5060 Spectrum Way, Suite 100, Ontario, Canada L4W 5N5 (phone: 800-463-6727, website: www.csa-international.org).

Safe Practice For Occupational And Educational Eye And Face Protection, ANSI Standard Z87.1, from American National Standards Institute, 25 West 43rd Street, New York, NY 10036 (phone: 212-642-4900, website: www.ansi.org).

Standard for Fire Prevention During Welding, Cutting, and Other Hot Work, NFPA Standard 51B, from National Fire Protection Association, Quincy, MA 02269 (phone: 1-800-344-3555, website: www.nfpa.org).

OSHA, Occupational Safety and Health Standards for General Industry, Title 29, Code of Federal Regulations (CFR), Part 1910, Subpart Q, and Part 1926, Subpart J, from U.S. Government Printing Office, Superintendent of Documents, P.O. Box 371954, Pittsburgh, PA 15250-7954 (phone: 1-866-512-1800) (there are 10 OSHA Regional Offices—phone for Region 5, Chicago, is 312-353-2220, website: www.osha.gov).

Applications Manual for the Revised NIOSH Lifting Equation, The National Institute for Occupational Safety and Health (NIOSH), 1600 Clifton Rd, Atlanta, GA 30333 (phone: 1-800-232-4636, website: www.cdc.gov/NIOSH).

Recommended Practices for Safe Oxyfuel Gas Cutting Torch Operation C4.2/C4.2M, and *Recommended Practices for Safe Oxyfuel Gas Heating Torch Operation C4.3/C4.3M* from Global Engineering Documents (phone: 1-877-413-5184, website: www.global.ihs.com).

SECTION 2 – INTRODUCTION



⚠ Inspect all equipment before use. Do not use damaged, defective, or improperly adjusted welding and cutting equipment. Make sure levers and valves work properly, threads on equipment are clean (no grease or oil) and not deformed, gauges are intact and easy to read, regulator is clean and free of oil or dirt, and fittings are properly sized for the cylinder. Make sure hoses are clean (no grease or oil) and ferrules are properly installed so the fitting does not slip inside the hose. Be sure all connections are tight and there are no leaks in the system.

This booklet offers basic information regarding the Medium Duty Oxy-Acetylene Cutting and Welding Outfit. Given reasonable care, this equipment will provide trouble-free use for many years.

SECTION 3 – HAZARDOUS EVENTS



The following events are very hazardous and can occur in any oxy-fuel system. It is important to understand these hazards and know how to prevent them.

Backfire: The return of the flame into the torch, usually accompanied by a popping sound. The flame may be extinguished or it may re-appear at the tip end.

Sustained Backfire: The return of the flame into the torch that continues to burn inside the torch with a hissing or squealing sound.

Flashback: The return of a flame into and through the torch or into the hose. In some instances it can reach the regulator and even enter the cylinder. This is generally caused by the mixing of the oxygen and fuel gas in the system. This is a very dangerous situation that can cause an explosion anywhere in the system. This is why purging is so important (see Sections 7-1 and 7-2).

SECTION 4 – ASSOCIATED HAZARDS OF RECOMPRESSING PURE OXYGEN



⚠ Open oxygen cylinder valves slowly. Opening an oxygen cylinder valve quickly can cause a fire or explosion. Be sure regulator adjusting handle is in the full out (off) position before opening an oxygen cylinder valve.

Recompressing high pressure oxygen in a low pressure cavity may create heat, resulting in combustion. For combustion to occur, oxygen, fuel, and kindling temperatures must be present. All of these components may be present when oxygen is recompressed by opening the tank valve too quickly.

Oxygen: High purity oxygen accelerates the rate of combustion, increases heat output, and lowers the combustible point at which various materials will burn.

Fuel: The fuel for combustion may be the regulator itself if enough heat is produced to reach the kindling temperature of the regulator's components.

Kindling Temperatures: Enough heat may be generated to ignite the regulator components by the friction created when recompressing high-pressure oxygen. This heat is known as the heat of recompression.

⚠ If an internal fire or flashback occurs (indicated by a whistling sound or inverted flame), do the following:

- Turn off the torch oxygen valve immediately.
- Turn off the torch fuel valve.
- Turn off the oxygen cylinder valve.
- Turn off the fuel gas cylinder valve.

Do not relight the torch until the equipment has cooled to the touch and the flashback cause has been determined and corrected.

SECTION 5 – SPECIFICATIONS

5-1. Equipment Included With The Kit

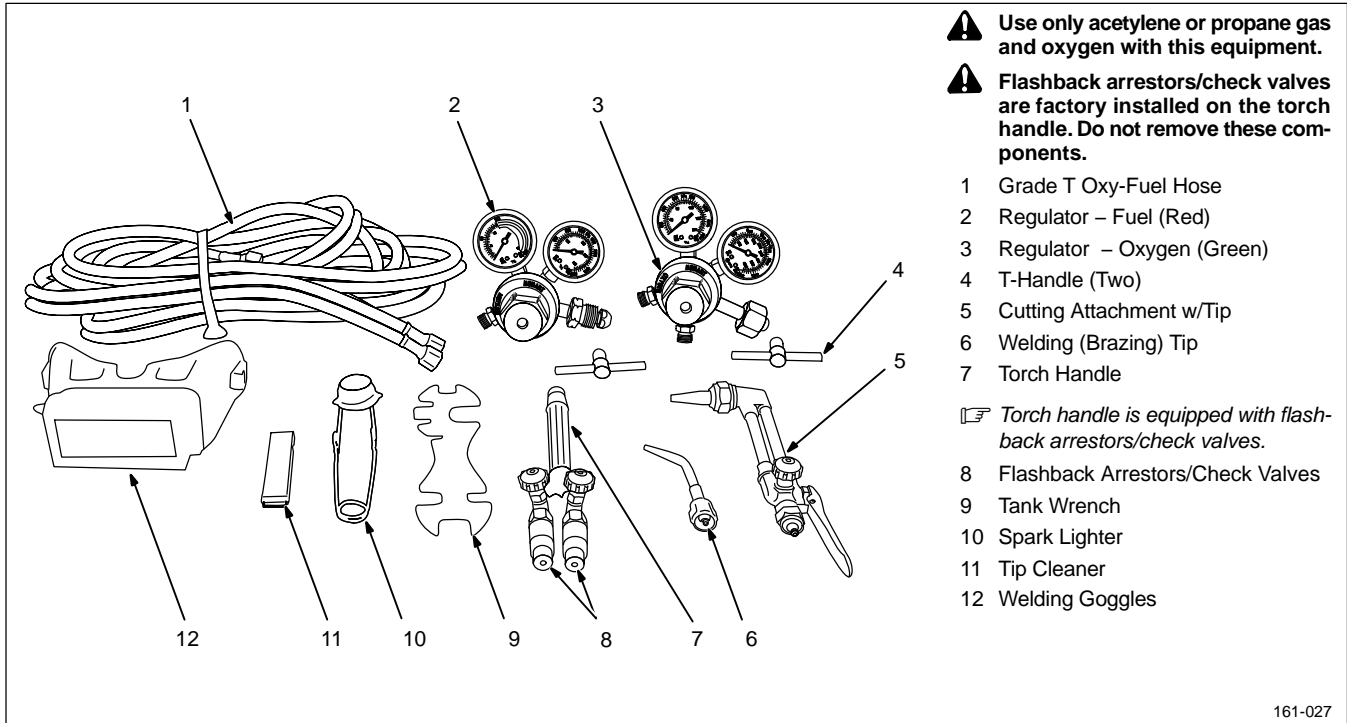

5-2. Specifications

Description	Fuel Gas	Cutting Capacity	Welding Capacity	Eye Protection	Hoses	Warranty
Medium Duty Oxy-Fuel Cutting and Welding Equipment	Acetylene Propane (with Optional Propane Tips)	Cuts Materials to 1/2 in. (12 mm) Thickness with Supplied Tips Cuts Materials to 6 in. (15 cm) Thickness with Optional Tips	Welds Materials to 3/32 in. (2.4 mm) Thickness with Supplied Tips Welds Materials to 1-1/4 in. (32 mm) Thickness with Optional Tips	Oxy-Fuel Goggle Flip Front No. 5 Shade 2 x 4-1/4 in. (51 x 108 mm)	Type T 3/16 in. ID x 20 ft (4.8 mm x 6 m)	Two-Year Limited

5-3. Welding (Brazing) Tip And Gas Pressure Guide

Welding (Brazing) Tip Selection Guide					
Hobart No.	Victor No.	Tip Size	Material Thickness	Fuel Gas Pressure	Oxygen Pressure
—	Type 13	000	28 – 22 Gauge	3 – 5 psi (21 – 34 kPa)	3 – 5 psi (21 – 34 kPa)
—	Type 13	00	22 – 16 Gauge	3 – 5 psi (21 – 34 kPa)	3 – 5 psi (21 – 34 kPa)
—	Type 13	0	16 – 14 Gauge	3 – 5 psi (21 – 34 kPa)	3 – 5 psi (21 – 34 kPa)
—	Type 13	1	14 – 12 Gauge	4 – 6 psi (28 – 41 kPa)	3 – 5 psi (21 – 34 kPa)
770 149	Type 13	2	12 – 10 Gauge	4 – 6 psi (28 – 41 kPa)	3 – 5 psi (21 – 34 kPa)
—	Type 13	3	1/8 – 3/16 in. (3 – 5 mm)	5 – 7 psi (34 – 48 kPa)	3 – 5 psi (21 – 34 kPa)

5-4. Cutting Tip And Gas Pressure Guide

Cutting Tip Selection Guide			
Tip Size	Material Thickness	Fuel Gas Pressure	Oxygen Pressure
00	1/4 in. (6 mm)	3 – 5 psi (21 – 34 kPa)	20 – 25 psi (138 – 172 kPa)
0	1/2 in. (13 mm)	3 – 5 psi (21 – 34 kPa)	25 – 30 psi (172 – 207 kPa)
1	9/16 in. (14mm)	3 – 5 psi (21 – 34 kPa)	30 – 35 psi (207 – 241 kPa)
2	3/4 in. (19 mm)	3 – 6 psi (21 – 41 kPa)	35 – 40 psi (241 – 276 kPa)
3	1-1/2 in. (38 mm)	4 – 8 psi (28 – 55 kPa)	40 – 45 psi (276 – 310 kPa)

5-5. Victor-Compatible Components

Acetylene Regulators And Gauges	
<i>☞ All Gauges Feature Dual Scales (psi/kPa)</i>	
Hobart No.	Description
770 504	LP/Acetylene Regulator w/CGA-510 Connection
770 127	LP Acetylene Low Pressure Gauge
770 125	LP/Acetylene High Pressure Gauge

Oxygen Regulators And Gauges	
<i>☞ All Gauges Feature Dual Scales (psi/kPa)</i>	
Hobart No.	Description
770 503	Oxygen Regulator CGA-540
770 128	Air/Oxygen Low Pressure Gauge
770 126	Air/Oxygen High Pressure Gauge

Oxy-Acetylene Gas Welding Hose				
<i>☞ R-grade hose is for acetylene gas. T-grade hose is for all gases, including propane.</i>				
Hobart No.	Description	Grade	Length	Diameter
770 130	Twin Welding Hose	R	25 ft (7.6 m)	3/16 in. (5 mm)
770 132		R	25 ft (7.6 m)	1/4 in. (6 mm)
770 133		R	50 ft (15.2 m)	1/4 in. (6 mm)
770 131		T	25 ft (7.6 m)	1/4 in. (6 mm)
770 515		R	100 ft (30.5 m)	1/4 in. (6 mm)

Acetylene Cutting Tips – 3-101	
Hobart No.	Size
770 153	No. 0 – 3/8 in. (10 mm)
770 154	No. 1 – 3/4 in. (19 mm)
770 155	No. 2 – 1 in. (25 mm)

Propane Cutting Tips – GPN	
Hobart No.	Size
770 162	No. 2 – 1 in. (25 mm)
770 172	No. 3 – 1-1/2 in. (38 mm)

Welding Tips – Type 13 (Medium/Light Duty)	
Hobart No.	Size
770 149	No. 2 – 1/16 – 1/8 in. (2 – 3 mm)

Heating Tips – Rosebud/MFA	
Hobart No.	Size
770 169	MFA-1 Med/Light Duty – SL No. 6

Victor-Compatible Cutting Attachment	
Hobart No.	Description
770 201	Medium Duty

Victor-Compatible Torch Handle	
Hobart No.	Description
770 200	Medium Duty

6-2. Installing Regulators On Cylinders

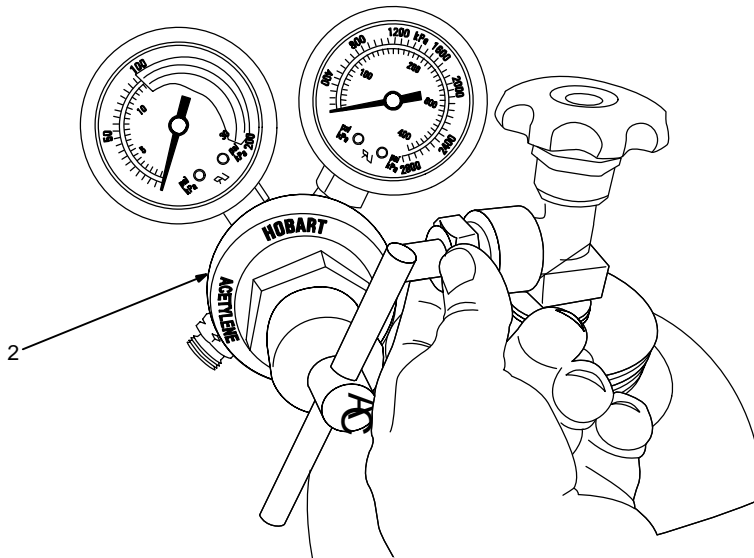
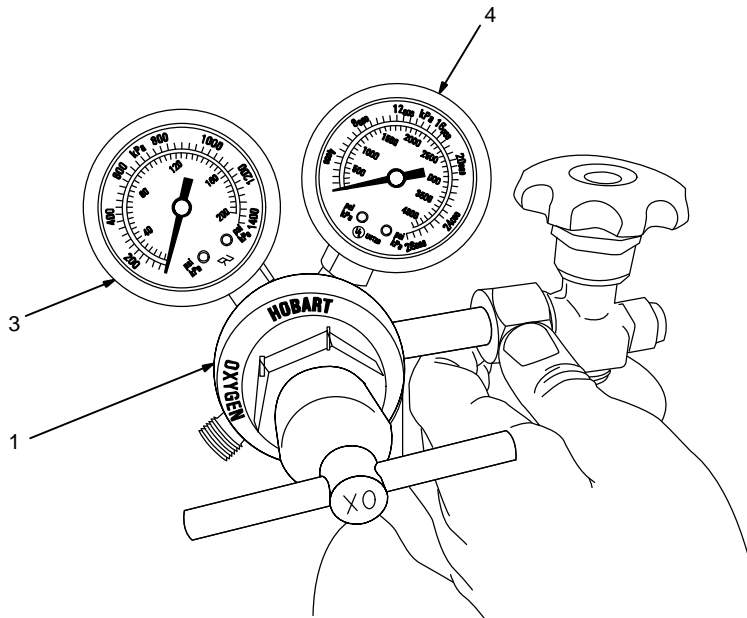
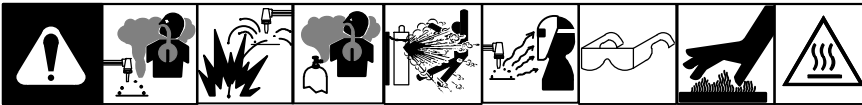

- Use only acetylene or propane gas and oxygen with this equipment.
- Do not slightly open or “crack” fuel cylinder valve to blow debris from the valve outlet. Remove the debris using nitrogen, air, or a clean, oil-free rag.
- Do not use petroleum-based pipe sealants.
- Do not handle oxygen regulators with oily hands and never apply oil to any part of an oxygen regulator.

NOTICE – Do not use cylinder adaptors to connect regulators to cylinders. Regulators have CGA connections (manufactured to standards of the Compressed Gas Association) which allow the regulator to only be installed on the appropriate cylinder valve for the intended gas.

Brass to brass connections generally do not require pipe sealant.

- 1 Oxygen Regulator (Green Label)
- 2 Fuel Regulator (Red Label)

The hex nut on the fuel regulator has notches on the corners. The hex nut corners are smooth on the oxygen regulator.

Install the two-piece fitting of the oxygen regulator (green) on the corresponding fitting on the oxygen cylinder. The oxygen cylinder has right-hand (clockwise) threads. Use supplied wrench to tighten hex nut.

Install the two-piece fitting of the fuel regulator (red) on the fuel cylinder (acetylene or propane only). The fuel cylinder has left-hand (counterclockwise) threads. Use supplied wrench to tighten hex nut.

Contact the gas supplier if the regulator fittings do not match the cylinder fittings.

- 3 Working Pressure Gauge
- 4 Cylinder Pressure Gauge

Each regulator has two gauges. The gauge closest to the cylinder shows the pressure in the cylinder. The other gauge shows the outlet pressure going to the torch handle.

Tools Needed:

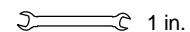

1 in.

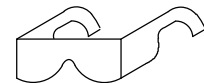

Pipe Sealant

6-3. Installing Hoses On Regulators

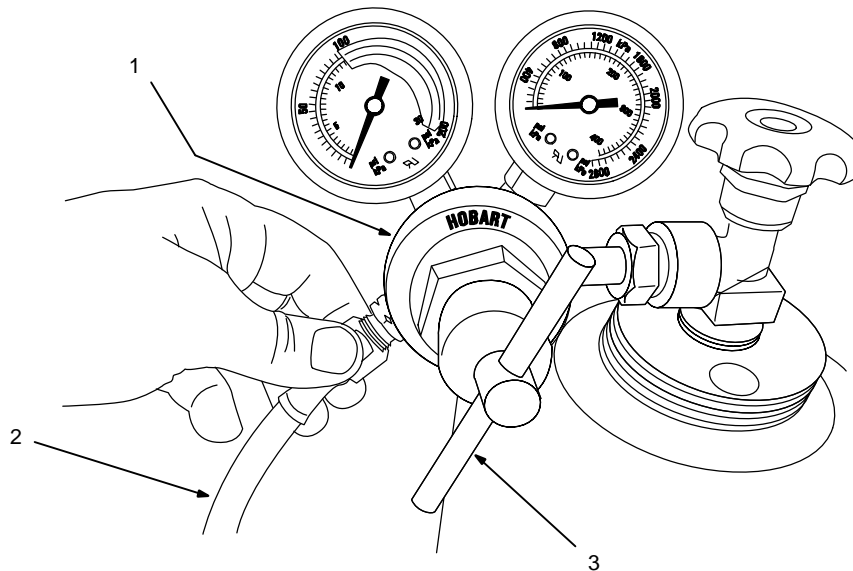
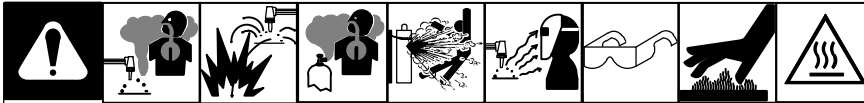

⚠ Use only industrial grade hose. Grade T hose (supplied with kit) is acceptable for all fuel gases. Grade R hose is for acetylene only.

⚠ Replace hoses at the first sign of any defects, flaws, or damage. The hoses should otherwise be replaced every four years. Inspect hoses for damage or leaks before each operation. Do not allow hoses to come in contact with hot metal, molten solder, or corrosive chemicals. Do not expose hoses to fluxing agents as these agents will deteriorate the hose materials and cause them to leak.

⚠ Do not splice or use damaged hoses.

- 1 Regulator
- 2 Hose
- 3 Adjustment Handle

Connect green hose to the regulator on the oxygen cylinder. Connect red hose to the regulator on the fuel gas cylinder.

ℹ The fuel fittings have left-handed threads.

Use supplied wrench to tighten fittings.

NOTICE – Before opening the cylinder valves, turn regulator adjusting screws all the way out to release pressure on the regulator diaphragm. Pressure may damage the regulators.

Stand with the oxygen cylinder valve between you and the regulator. Slowly open the oxygen cylinder valve 1/4 turn until the tank pressure stabilizes, then fully open the oxygen valve to seat it in the open position.

Tighten the adjustment handle (on the regulator adjustment screw) to bring the pressure up to 5 psi (34 kPa). Allow oxygen to flow through hose for about 10 seconds. Stop oxygen flow by turning adjustment handle counter-clockwise.

Stand with the fuel cylinder valve between you and the regulator. Slowly open the fuel cylinder valve 1/4 turn until the tank pressure stabilizes, then open the fuel valve to a maximum of one full turn (acetylene) or fully open (all other fuel gases). Leave wrench on cylinder so cylinder can be shut off quickly.

Tighten the adjustment handle (on the regulator adjustment screw) to bring the pressure up to 5 psi (34 kPa). Allow fuel gas to flow through hose for about 10 seconds. Stop fuel gas flow by turning adjustment handle counter-clockwise.

Tools Needed:

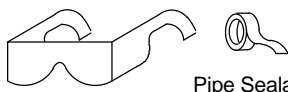

Pipe Sealant

161-030

6-4. Attaching Hoses To Torch Flashback Arrestors/Check Valves

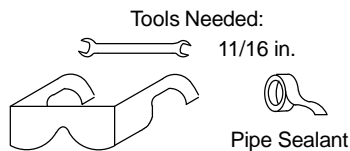
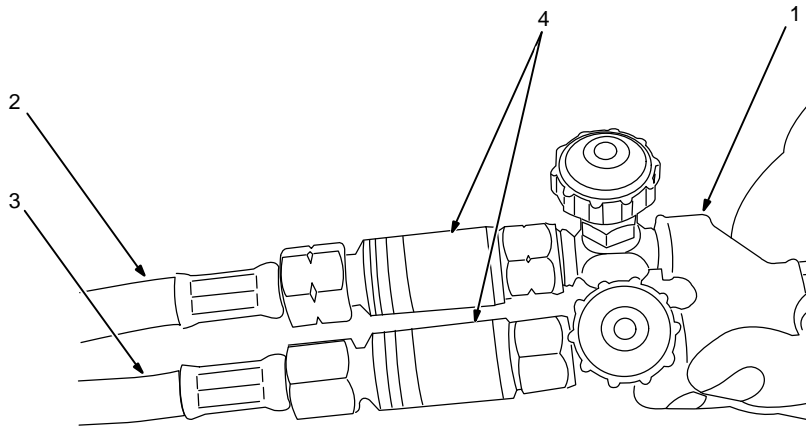

- ⚠ Do not use petroleum-based pipe sealants.
- ⚠ Flashback arrestors/check valves are factory installed on the torch handle. Do not remove these components.

☞ The hex nut on the fuel hose has notches on the corners. The hex nut corners are smooth on the oxygen hose.

- 1 Torch Handle
- 2 Fuel Hose (Red)
- 3 Oxygen Hose (Green)
- 4 Flashback Arrestors/Check Valves

Flashback arrestors/check valves are designed to prevent the reverse flow of gases and stop a flashback from going beyond the point where they are installed.

Attach fuel hose (red) to fuel inlet fitting on torch flashback arrestor. The nut on the fuel hose has left-hand threads.

Attach oxygen hose (green) to oxygen inlet fitting on torch flashback arrestor. The nut on the oxygen hose has right hand threads.

Use supplied wrench to tighten connections.

161-031

6-5. Attaching Cutting Attachment To Torch Handle

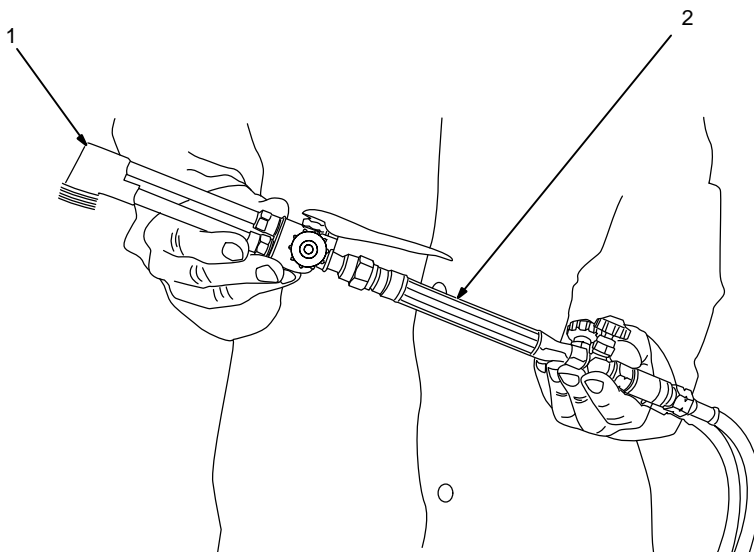

- ⚠ Do not use cutting attachment if the o-rings are missing or damaged.
- ⚠ Do not use petroleum-based pipe sealants.

☞ See Section 6-7 for attaching brazing tip to torch handle.

- 1 Cutting Attachment
- 2 Torch Handle

The cutting attachment uses two o-rings to seal the connection to the torch handle. If replacing the cutting attachment, be sure the o-rings are properly installed.

Attach cutting attachment to torch handle.

Use supplied wrench to tighten connections.

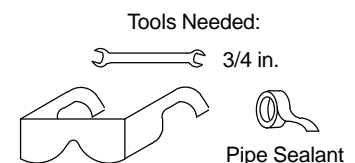

161-032

6-6. Installing Cutting Tip On Cutting Attachment

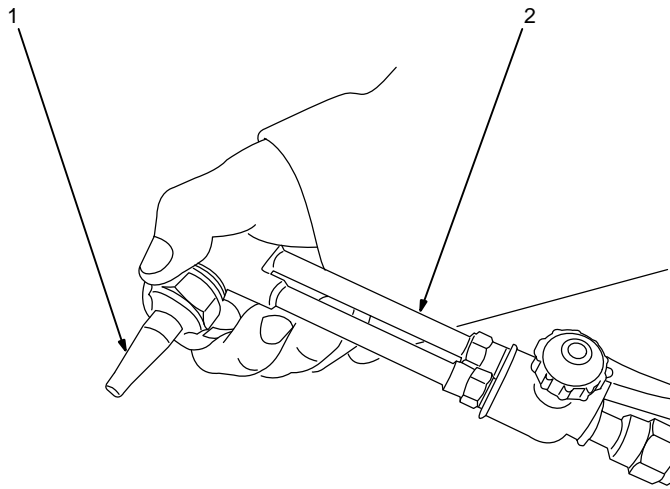

Tools Needed:

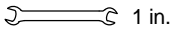

1 in.

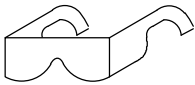

Pipe Sealant

⚠ Do not use petroleum-based pipe sealants.

NOTICE – Do not drop or mishandle the cutting tip or the seating surface may be damaged.

Cutting tips are available in different sizes to accommodate various metal thicknesses. Use the table in Section 5-4 to select the correct tip, and to determine the correct fuel and oxygen pressures.

Inspect cutting tips for damage and to ensure that the cutting orifice and preheat holes are not blocked with dirt or slag.

☞ A No. 0 cutting tip is already installed in the cutting attachment.

- 1 Cutting Tip
- 2 Cutting Attachment

Install correct cutting tip in cutting attachment.

Use supplied wrench to tighten connections.

161-033

6-7. Attaching Welding/Brazing Tip To Torch Handle

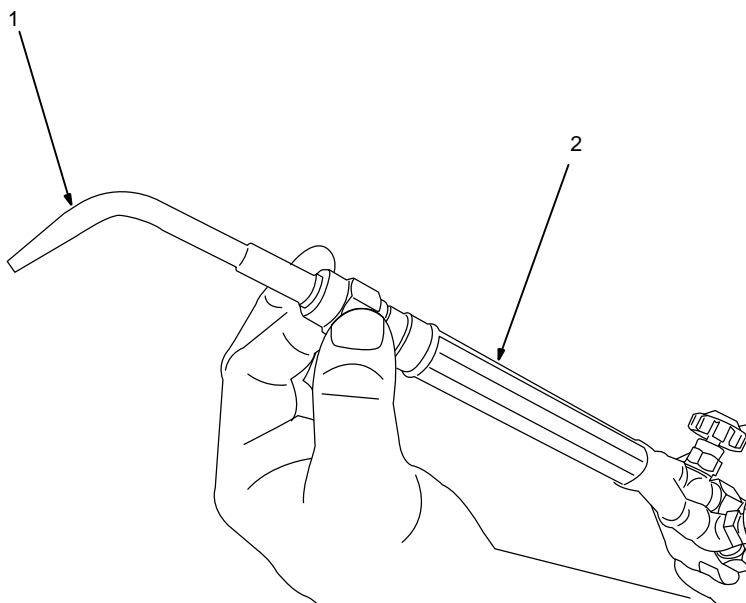

⚠ Do not use petroleum-based pipe sealants.

Welding/brazing tips are available in different sizes to accommodate various metal thicknesses. Use the table in Section 5-4 to select the correct tip, and to determine the correct fuel and oxygen pressures.

☞ A No. 0 welding/brazing tip with mixer is supplied with the kit.

- 1 Welding/Brazing Tip With Mixer
- 2 Torch Handle

Attach welding/brazing tip to torch handle.

Use supplied wrench to tighten connections.

Tools Needed:

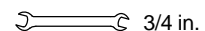

3/4 in.

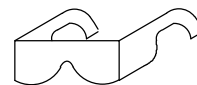

Pipe Sealant

161-034

6-8. Testing The System For Leaks

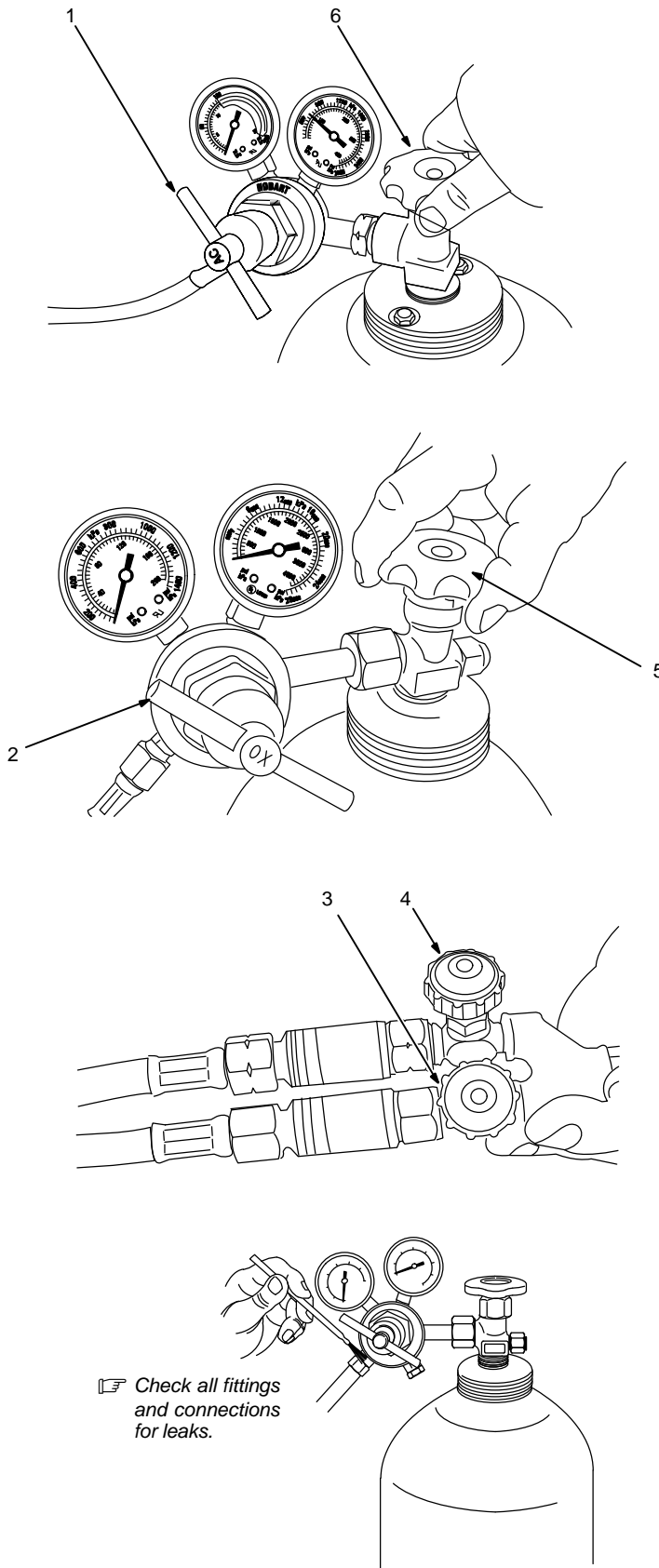
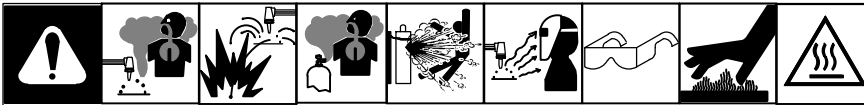

☞ Check all fittings and connections for leaks.

⚠ Leak test the system before lighting the torch. Repeat this procedure every time the equipment is set up or a cylinder is changed.

⚠ Use an approved oil-free leak detection fluid or leak detector to locate possible leaks.

⚠ Do not stand in front of or behind the regulator when opening the cylinder valve. Never open a cylinder valve suddenly as this can damage a regulator or cause an oxygen regulator fire.

- 1 Fuel Regulator Adjustment Handle
- 2 Oxygen Regulator Adjustment Handle
- 3 Torch Handle Fuel Valve
- 4 Torch Handle Oxygen Valve
- 5 Oxygen Cylinder Valve
- 6 Fuel Cylinder Valve

Turn the fuel and oxygen regulator adjustment handles to the Off position (counterclockwise).

Close the fuel and oxygen valves on the torch handle.

Slowly open the oxygen cylinder valve one turn and adjust pressure to 20 psi (138 kPa) by turning oxygen regulator adjustment handle clockwise.

Slowly open the fuel cylinder valve and adjust pressure to 10 psi (69 kPa) by turning fuel regulator adjustment handle clockwise.

Check every connection and joint from the cylinder valve to the torch tip with an approved leak detection solution or leak detector. If leaks are detected, eliminate them before proceeding. If leaks cannot be eliminated, do not put the equipment into service until it has been repaired or replaced.

Close cylinder valves.

Tools Needed:

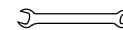
 11/16, 3/4, 1 in.

  Pipe Sealant

SECTION 7 – OPERATION

7-1. Purging Oxygen From The System And Adjusting Oxygen Pressure

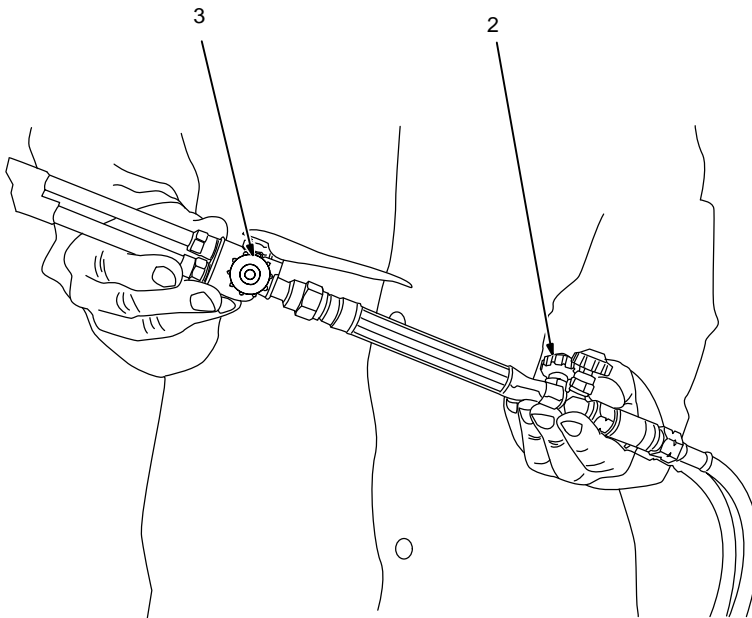
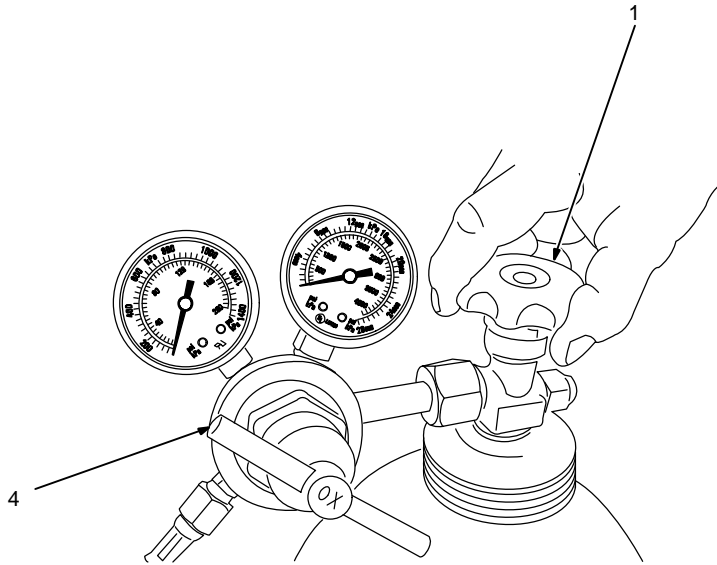

⚠ Inspect all equipment before use. Do not use damaged, defective, or improperly adjusted welding and cutting equipment. Make sure levers and valves work properly, threads on equipment are clean (no grease or oil) and not deformed, gauges are intact and easy to read, regulator is clean and free of oil or dirt, and fittings are properly sized for the cylinder. Make sure hoses are clean (no grease or oil). Be sure all connections are tight and there are no leaks in the system.

⚠ Always purge gas from the system before lighting torch to prevent a possible mixed-gas explosion. Purge gas in a well ventilated area and away from flame or sparks.

☞ See Sections 5-4 and 5-3 for oxygen and fuel pressure recommendations.

☞ Purge fuel from the system according to Section 7-2.

Purging Oxygen And Setting Pressure

- 1 Oxygen Cylinder Valve
- 2 Torch Handle Oxygen Valve
- 3 Preheat Oxygen Valve
- 4 Oxygen Regulator Adjustment Handle

Slowly open the oxygen cylinder valve until valve is fully open.

Open oxygen valve on torch 1/4 turn for five to ten seconds. (If using welding attachment, also open preheat oxygen valve.) While the oxygen is flowing, turn the adjustment handle on the oxygen regulator to achieve the desired working pressure.

Close the oxygen valve and the preheat oxygen valve on the torch handle.

Purge fuel from the system and adjust fuel pressure according to Section 7-2.

Tools Needed:



7-2. Purging Fuel From The System And Adjusting Fuel Pressure

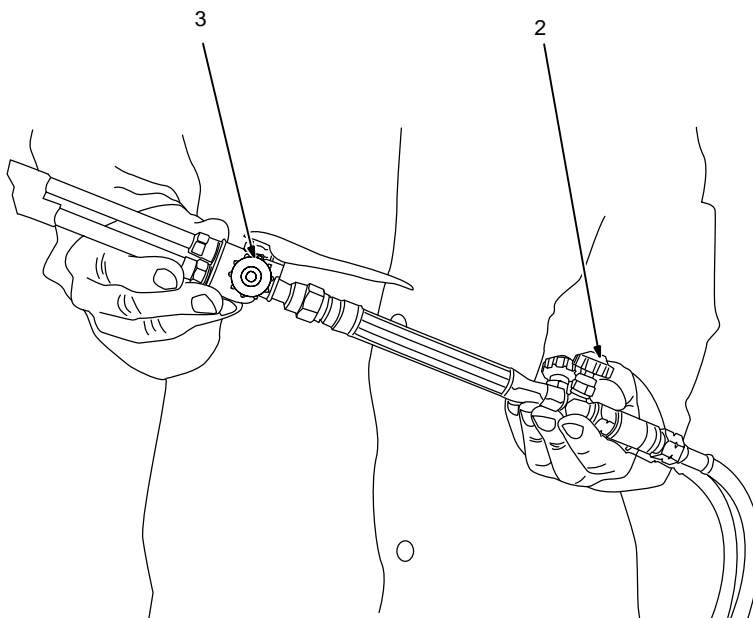
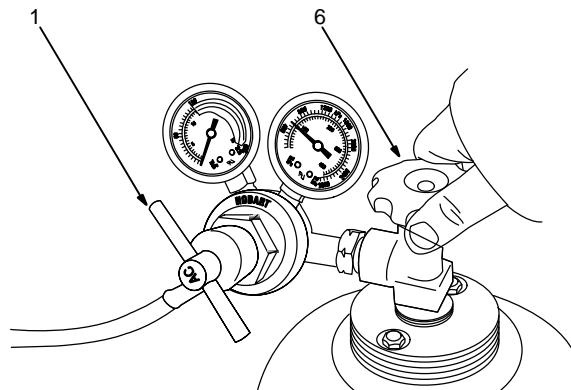
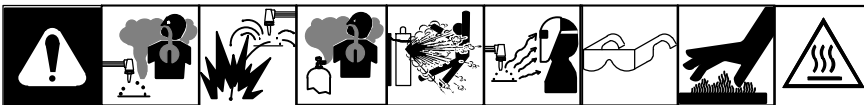

⚠ Inspect all equipment before use. Do not use damaged, defective, or improperly adjusted welding and cutting equipment. Make sure levers and valves work properly, threads on equipment are clean (no grease or oil) and not deformed, gauges are intact and easy to read, regulator is clean and free of oil or dirt, and fittings are properly sized for the cylinder. Make sure hoses are clean (no grease or oil). Be sure all connections are tight and there are no leaks in the system.

⚠ Always purge gas from the system before lighting torch to prevent a possible mixed-gas explosion. Purge gas in a well ventilated area and away from flame or sparks.

☞ See Sections 5-4 and 5-3 for oxygen and fuel pressure recommendations.

☞ Purge oxygen from the system according to Section 7-1.

Purging Fuel And Setting Fuel Pressure

- 1 Fuel Cylinder Valve
- 2 Torch Handle Fuel Valve
- 3 Preheat Oxygen Valve
- 4 Fuel Regulator Adjustment Handle

Slowly open the fuel cylinder valve one turn maximum (for acetylene). Fully open fuel cylinder valve for all other fuel gases.

Open fuel valve on torch 1/4 turn for five to ten seconds. (If using welding attachment, also open preheat oxygen valve.) While the fuel is flowing, turn the adjustment handle on the fuel regulator to achieve the desired working pressure.

Close the fuel valve and the preheat oxygen valve on the torch.

Tools Needed:

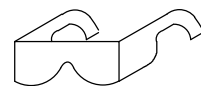

7-3. Lighting And Using The Cutting Torch

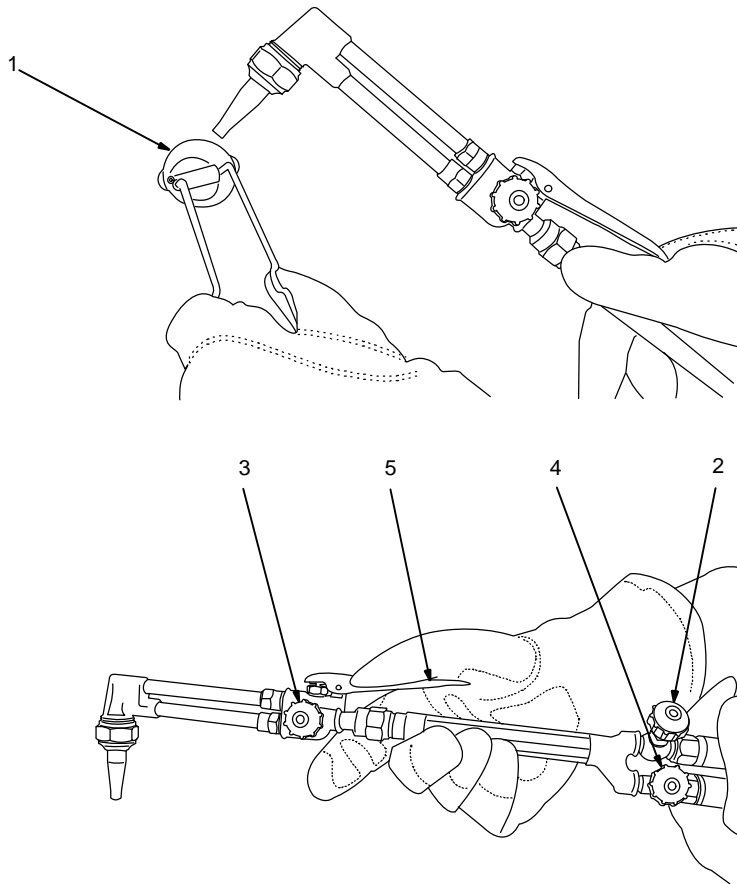
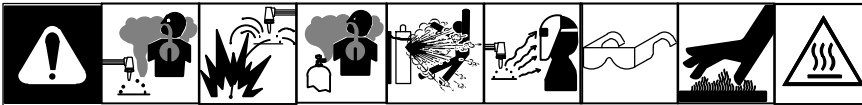

Tools Needed:

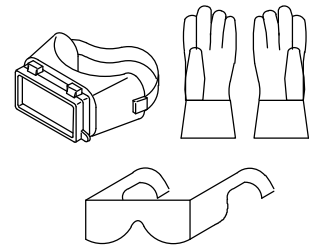

161-037 / 038

- ⚠** Always purge gas from the system before lighting torch to prevent a possible mixed-gas explosion. Purge gas in a well ventilated area and away from flame or sparks. See Sections 7-1 and 7-2.

- ⚠** Do not use matches or a cigarette lighter to ignite the gas.

☞ See Sections 5-4 and 5-3 for oxygen and fuel pressure recommendations.

☞ See Sections 7-1 and 7-2 for information on adjusting oxygen and fuel pressure.

- 1 Spark Lighter
- 2 Oxygen Valve
- 3 Preheat Oxygen Valve
- 4 Fuel Valve
- 5 Cutting Lever

Lighting The Torch

Hold the spark lighter near the torch tip.

Slowly open the fuel valve on the torch handle 1/4 turn and quickly squeeze the spark lighter to light the flame.

Slowly open the oxygen valve on the torch to the desired pressure.

Continue to open the fuel valve until the black sooty smoke disappears and the flame begins to move away from the tip.

- ⚠** Failure to force a sufficient amount of fuel gas through the tip will cause the tip to overheat and may cause a flashback or backfire.

Slowly open the preheat oxygen valve on the cutting attachment; a white-hot feather (flame) appears.

Slowly add oxygen until the feather begins to disappear into the bright cone at the end of the tip. This produces a neutral flame (ratio of fuel to oxygen is 1:1).



Neutral Flame
Even mixture of fuel and oxygen

Using The Cutting Torch

Hold the torch tip about 1/4 in. (6 mm) from the metal to be cut.

Heat the metal until it is bright red (about 1550° F or 843° C).

Slowly depress the cutting lever on the cutting attachment. Let the oxygen stream burn through the metal, then completely depress the lever to begin the cutting process.

When Finished Cutting

NOTICE – Shut down the torch in the correct sequence or the torch may be damaged. Oxygen must be released from the system first or residual fuel in the handle or fuel hose may burn. Fuel cannot burn without oxygen.

When finished cutting, release the cutting lever. Close the oxygen preheat valve on the torch handle first and then close the fuel valve on the torch handle.

Turn valves at fuel and oxygen cylinders clockwise to the closed position.

Open the fuel valve on the torch handle to relieve pressure; both gauges on the fuel regulator should indicate zero (0) pressure. Close the fuel valve on the torch handle.

Turn fuel regulator adjustment handle counterclockwise until there is no pressure on the regulator diaphragm.

Open the preheat oxygen valve on the torch handle to relieve pressure; both gauges on the oxygen regulator should indicate zero (0) pressure. Close the preheat oxygen valve and oxygen valve on the torch handle.

Turn oxygen regulator adjustment handle counterclockwise until there is no pressure on the regulator diaphragm.

7-4. Lighting And Using The Brazing Tip

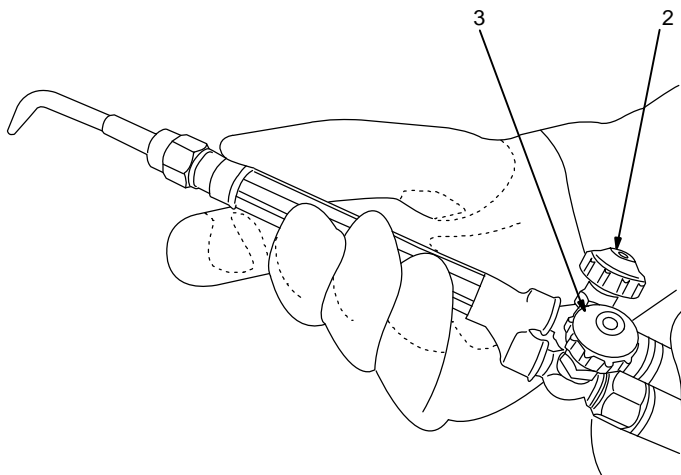
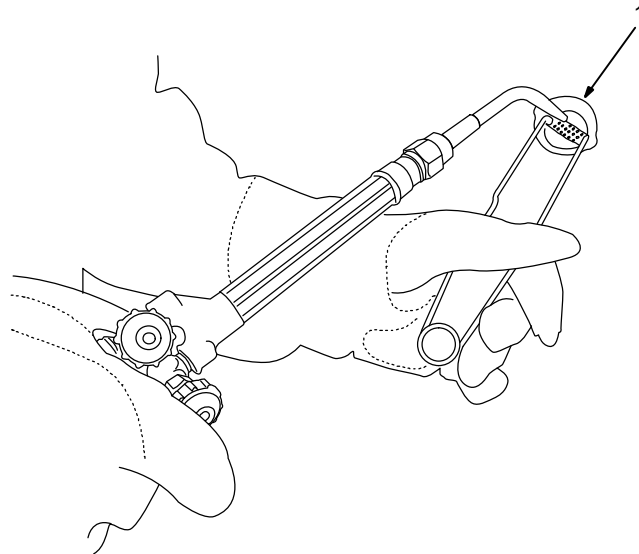
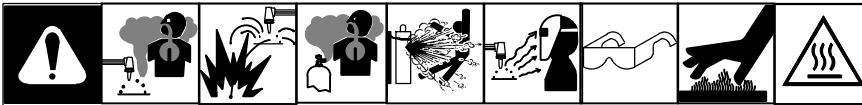

Tools Needed:

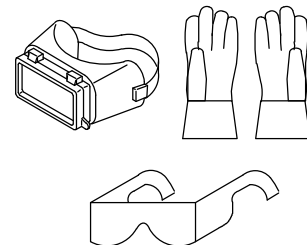

161-039 / 040

⚠ Always purge gas from the system before lighting torch to prevent a possible mixed-gas explosion. Purge gas in a well ventilated area and away from flame or sparks. See Sections 7-1 and 7-2.

⚠ Do not use matches or a cigarette lighter to ignite the gas.

⚠ Do not allow the flame to touch the brazing tip or allow the brazing tip to overheat.

☞ See Sections 5-4 and 5-3 for oxygen and fuel pressure recommendations.

☞ See Sections 7-1 and 7-2 for information on adjusting oxygen and fuel pressure.

- 1 Spark Lighter
- 2 Oxygen Valve
- 3 Fuel Valve

Lighting The Torch

Hold the spark lighter near the torch tip.

Slowly open the fuel valve on the torch handle about 1/8 turn and quickly squeeze the spark lighter to light the flame.

Slowly open the oxygen valve on the torch to neutralize the flame.

Open the fuel valve on the torch handle another 1/8 turn and then increase the oxygen to neutralize the flame.

Continue this procedure until the maximum amount of fuel gas is used and the desired flame is present.

When Finished Welding/Brazing

NOTICE – Shut down torch in correct sequence or the torch may be damaged. Oxygen must be released from the system first or residual fuel in the handle or fuel hose may burn. Fuel cannot burn without oxygen.

When finished welding/brazing, close the oxygen valve on the torch handle first and then close the fuel valve on the torch handle.

Turn valves at fuel and oxygen cylinders clockwise to the closed position.

Open the fuel valve on the torch handle to relieve pressure; both gauges on the fuel regulator should indicate zero (0) pressure. Close the fuel valve on the torch handle.

Turn fuel regulator adjustment handle counterclockwise until there is no pressure on the regulator diaphragm.

Open the oxygen valve on the torch handle to relieve pressure; both gauges on the oxygen regulator should indicate zero (0) pressure. Close the oxygen valve on the torch handle.

Turn oxygen regulator adjustment handle counterclockwise until there is no pressure on the regulator diaphragm.

HOBART®

Thank you for purchasing Hobart. Our trained technical support team is dedicated to your satisfaction. For questions regarding performance, operation, or service, contact us!

Resources Available

Always provide Model Name and Serial/Style Number.

To locate a Service Center:

Call 1-800-332-3281
or visit our website at www.HobartWelders.com/wheretobuy

For Technical Assistance:

Call 1-800-332-3281
7 AM to 5 PM EST – Monday through Friday



Owner's Record

Please complete and retain with your personal records.

Model Name	Serial/Style Number
Purchase Date	(Date which equipment was delivered to original customer.)
Distributor	
Address	
City	
State	Zip

Hobart Brothers Co.
An Illinois Tool Works Company
2200 Corporate Drive
Troy, OH 45373 USA

For Assistance:
Call 1-800-332-3281

HOBART®