



OM-221 534C

2006-03





**Auto-Darkening Welding Helmet  
XT Series  
Models: XTF/XTV/XTP**



# Table Of Contents

<b>SECTION 1 – SAFETY PRECAUTIONS – READ BEFORE USING .....</b>	<b>1</b>
<b>SECTION 2 – SPECIFICATIONS .....</b>	<b>2</b>
<b>SECTION 3 – OPERATING INSTRUCTIONS .....</b>	<b>5</b>
<b>SECTION 4 – BATTERY REPLACEMENT .....</b>	<b>8</b>
<b>SECTION 5 – MAINTENANCE .....</b>	<b>8</b>
<b>SECTION 6 – TROUBLESHOOTING .....</b>	<b>9</b>
<b>SECTION 7 – LIMITED WARRANTY .....</b>	<b>10</b>
<b>SECTION 8 – REPLACEMENT PARTS .....</b>	<b>11</b>

## SECTION 1 – SAFETY PRECAUTIONS – READ BEFORE USING

	<p><b>Warning! Watch Out! There are possible hazards as shown in the adjoining symbols.</b></p> <ul style="list-style-type: none"><li>• Read and follow Section 1 for all safety symbols.</li></ul>
	<p><b>ARC RAYS can burn eyes and skin.</b></p> <p>Arc rays from the welding process produce intense visible and invisible (ultraviolet and infrared) rays that can burn eyes and skin. Sparks fly off from the weld.</p> <ul style="list-style-type: none"><li>• Wear a welding helmet fitted with a proper shade of filter to protect your face and eyes when welding or watching (see ANSI Z49.1 and Z87.1 listed in Safety Standards). Refer to Shade and Sensitivity charts in Section 2.</li><li>• Wear approved safety glasses with side shields under your helmet.</li><li>• Use protective screens or barriers to protect others from flash and glare; warn others not to watch the arc.</li><li>• Wear protective clothing made from durable, flame-resistant material (leather and wool) and foot protection.</li></ul>
	<p><b>WELDING HELMETS do not provide unlimited eye, ear and face protection.</b></p> <ul style="list-style-type: none"><li>• Use impact resistant safety spectacles or goggles and ear protection at all times when using this welding helmet.</li><li>• Do not use this helmet while performing grinding operations, working with or around explosives or corrosive liquids.</li><li>• Do not weld in the overhead position while using this helmet.</li><li>• Inspect the auto-lens frequently. Immediately replace any scratched, cracked, or pitted cover lenses or auto-lenses.</li></ul>
	<p><b>NOISE can damage hearing.</b></p> <p>Noise from some processes or equipment can damage hearing.</p> <ul style="list-style-type: none"><li>• Wear approved ear protection if noise level is high.</li></ul>

## SECTION 2 – SPECIFICATIONS

### XTF Technical Specifications (Fixed Shade #10)

Cartridge Dimensions	4.33 x 3.54 x 0.39 in (110 x 90 x 10 mm)
Viewing Field	3.75 x 1.37 in (95 x 35 mm)
Reaction Time	Light to dark: 0.00028 second (1/3,600) Dark to light: 0.12 second
Available Shades	Darkened State: #10 / Light State: #3
Sensors	Independent (Two)
Operating Temperature	23°F to 131°F (-5°C to +55°C)
Storage Temperature	-4°F to 176°F (-20°C to +80°C)
Power Supply	Battery-powered, solar rechargeable (internal, non-replaceable lithium battery)
Total Weight	1 lb (454g)
Standards	ANSI Z87.1-2003/CSA
Warranty	2 years from date of purchase (see Section 7)

**NOTE:** Expose the solar cell to bright sunlight for 30 minutes before use.

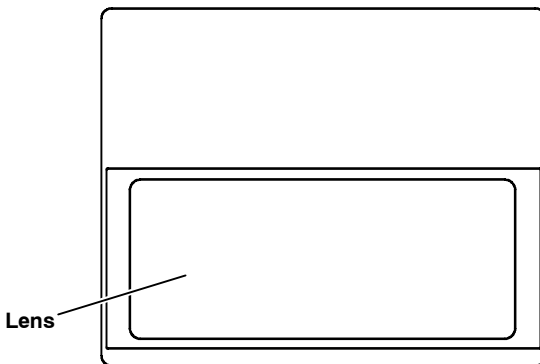

## XTV Technical Specifications (#9 – #12 Variable Shade)

Cartridge Dimensions	4.33 x 3.54 x 0.39 in (110 x 90 x 10 mm)
Viewing Field	3.75 x 1.57 in (95 x 40 mm)
Reaction Time	0.000083 second (1/12,000)
Available Shades	ANSI: Darkened State: #9 – 12 / Light State: #4 CE/CSA: Darkened State: #9 – 13 / Light State: #4
Sensors	Independent/redundant (Two)
Operating Temperature	23°F to 131°F (-5°C to +55°C)
Storage Temperature	-14°F to 158°F (-10°C to +70°C)
Power Supply	2 AAA Alkaline batteries (included)
Total Weight	1 lb (454g)
Standards	ANSI Z87.1-2003 CE/CSA
Warranty	2 years from date of purchase (see Section 7)
Sensitivity Control light levels	Adjusts for varying ambient light and welding arc
Delay Control	Slows lens dark-to-light state between 0.1 and 0.5 seconds (fast/slow switch)
Automatic Power Off	Shuts lens off 15–20 minutes after last arc is struck
Low Battery Indicator	Red LED light illuminates to indicate low battery

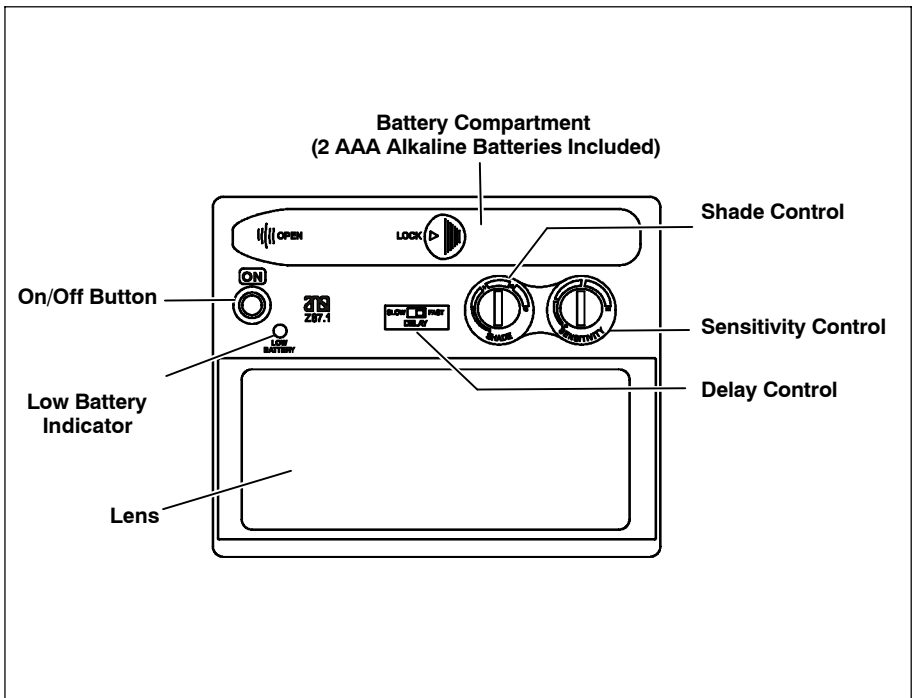

## XTP Technical Specifications (Professional #9 – #13 Variable Shade)

Cartridge Dimensions	4.33 x 3.54 x 0.39 in (110 x 90 x 10 mm)
Viewing Field	3.81 x 1.85 in (97 x 47 mm)
Reaction Time	0.0000625 second (1/16,000)
Available Shades	Darkened State: #9 – 13 / Light State: #4
Sensors	Independent/redundant (Two)
Operating Temperature	140°F to 1310°F (60°C to +710°C)
Storage Temperature	-40°F to 1580°F (-40°C to +860°C)
Power Supply	CR2450 Lithium battery (Hobart 770284)
Total Weight	1 lb (454g)
Standards	ANSI Z87.1-2003/DIN/CE/TUV/CSA
Warranty	2 years from date of purchase (see Section 7)
Sensitivity Control light levels	Adjusts for varying ambient light and welding arc
Delay Control	Slows lens dark-to-light state between 0.1 and 1.0 seconds (infinite dial control)
Automatic Power Off	Shuts lens Off 15–20 minutes after last arc is struck
Low Battery Indicator	Red LED light illuminates to indicate low battery

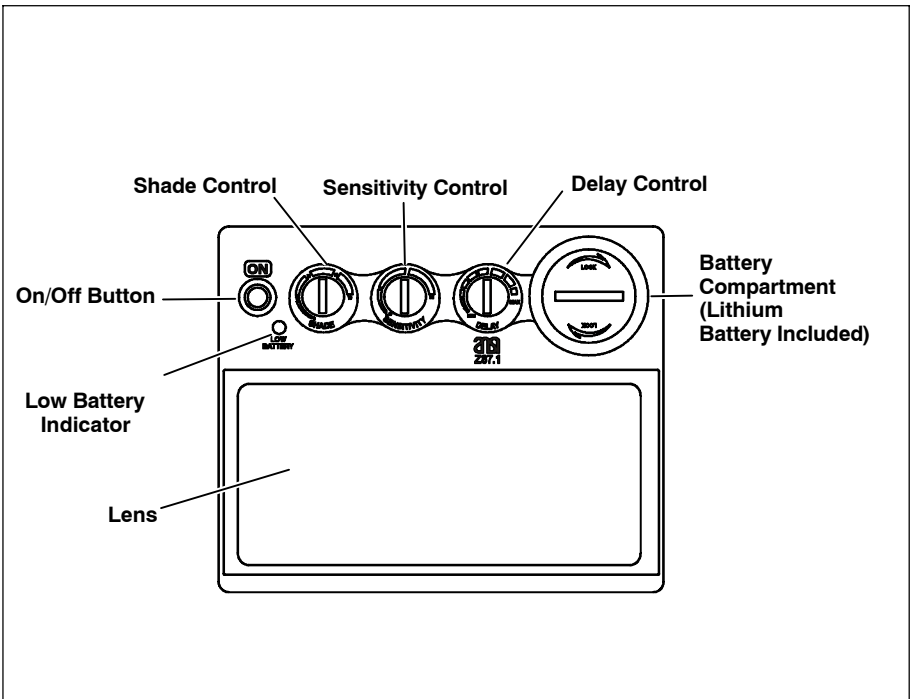

## SECTION 3 – OPERATING INSTRUCTIONS

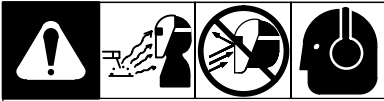

### On/Auto-Off Button

Locate the ON button and press ON to weld. The lens will automatically darken twice and then return to the light state. The helmet is then ready to weld.

**Note:** The lens will Auto-Off (clear state – #4) 15–20 minutes after the last arc. It will be necessary to press the ON button to resume welding.

**Note:** The XTF model has no On/Auto-Off button; the helmet turns on automatically.

### Variable Shade Control

**Model XTF – Fixed Shade #10**

**Model XTV – Variable Shade #9 – #12**

**Model XTP – Variable Shade #9 – #13**

Use the shade chart below to select proper shade control setting based on your welding process. We recommend starting at shades 12 or 13 and adjust lighter based on the welding application and personal preference.

Application Welding	Arc Current in Amperes	Protective Shade No.
Stick Electrodes	Less than 40 40–80 80–175 175–300	#9 #10 #11 #12 – #13
MIG	Less than 100 100–175 175–300	#10 #11 #12 – #13
Gas Tungsten Arc Welding (TIG)	Less than 50 50–100 100–200 200–300	#10 #11 #12 #13



### Sensitivity Control (XTV And XTP Models Only)

The sensitivity control is used to make the lens more responsive to differing light levels experienced in various welding processes. **We recommend a (Mid-Range or 30–50%) sensitivity setting for most applications.** Please refer to the chart below for recommended settings.

### Recommended Sensitivity Settings

Stick Electrode	Mid-Range
Short Circuiting (MIG)	Low/Mid-Range
Gas Tungsten Arc (TIG)	Mid/High-Range
Plasma Arc Cutting/Welding	Low/Mid-Range

### Helpful Hint For Setting Sensitivity In Low Amperage Tig, 50 Amps And Below:

1. Face the helmet front toward the floor.
2. Turn the sensitivity setting toward HI until the lens darkens.
3. Now, reduce the sensitivity by turning the control to the left until the lens lightens; you are then ready to weld.
4. When job is completed, return sensitivity control to mid-range.

### Lens Delay Control

The lens delay control is used to slow the lens-switching time to the clear state after welding. The delay is particularly useful in eliminating bright after-rays present in higher amperage applications where the molten puddle remains bright momentarily after welding.

### Low Battery Indicator

The low battery indicator lights when 2–3 days of battery life remain (see battery recommendations below).

Model XTF: Non-replaceable Lithium battery.

Model XTV: Replace with 2 AAA Alkaline batteries.

Model XTP: Replace with Lithium battery CR2450.





## Adjustment of the Headgear for Maximum Comfort

There are four adjustments on Hobart headgear that can be adjusted for maximum comfort:

1. Headgear Top – Adjusts headgear for proper depth on the head to ensure correct balance and stability.
2. Headgear tightness – To adjust, turn knob located on the back of the headgear left or right to desired tightness.
3. Stop angle adjustment – Five pins on the right side of the headband top provide adjustment for the forward tilt of the helmet. To adjust, loosen the right outside tension adjustment knob and lift on the control arm tab to move it to the desired position. Retighten tension adjustment knob.
4. Distance adjustment – Adjusts the distance between the face and the lens. To adjust, loosen both outside tension knobs and slide forward or back to desired position and retighten. (Both sides must be equally positioned for proper vision.)



## Replacement of the Front and Inside Lens Covers

**▲ Warning! Never use the auto-darkening lens without the inside and outside lens covers properly installed. Welding spatter will damage the auto-darkening lens voiding the warranty.**

1. Outside – Place helmet on a flat surface. Grasp the front lens holder with one hand while pushing the inside retaining clips of the lens holder outward. Do one side at a time, gently pulling the front lens holder away from the helmet as each tab is released from its retaining clip. Once released, the outside cover lens can be replaced.
2. Inside – Remove the inside lens cover by following the procedure in Step 1. With the auto-darkening lens removed from the helmet, remove the inside cover lens by prying the lens up at the thumbnail opening located at the top center of the cover lens. Replace the lens by gently bowing it in the center and inserting it, one end at a time, into the retaining clips located on the outside of the auto-darkening lens assembly.
3. Reinstalling auto-darkening lens assembly – Gently place auto-darkening lens in front of helmet. (Be careful not to drop lens.) Install front lens cover with gasket. Grasp front lens holder and slowly insert the six retaining pieces into front of helmet. (Make certain you gently squeeze the outside edges of the front lens holder while inserting tabs into helmet.) From the inside of helmet, gently push the retaining tabs in to secure the front lens holder in place.

## SECTION 4 – BATTERY REPLACEMENT

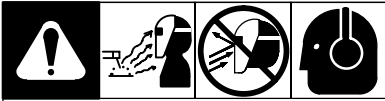

Model XTV: Remove the batteries by sliding the cover plate to the left. Replace with 2 AAA alkaline batteries. (**Note:** be sure the positive (+) side of the battery is aligned with positive (+) terminal.) Replace cover plate and then press On button.

Model XTP: Remove the batteries by turning the battery cover counter-clockwise 90 degrees. Replace with Lithium battery CR2450. (**Note:** be sure the battery positive (+) terminal is up.) Replace the cover and then press On button.

**NOTE:** The XTF model has a non-replaceable Lithium battery.

## SECTION 5 – MAINTENANCE

### Cleaning

The helmet requires little maintenance, however for best performance we recommend cleaning after use. Using a soft cloth dampened with a mild soap and water solution, wipe the cover lenses clean. Allow to air dry. Occasionally, the filter lens and sensors should be cleaned by gently wiping with a soft, dry cloth. (**Never use solvents or abrasive cleaning detergents. Do not immerse the lens assembly in water.**)

## SECTION 6 – TROUBLESHOOTING

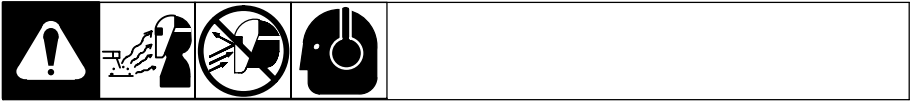

Symptom	Solution
Not ON – auto-lens will not darken momentarily when turned on.	Check batteries and make sure that they are in good condition and installed properly. Also, check battery surfaces and contacts and clean if necessary. Check battery for proper contact and gently adjust contact points if necessary. This is particularly important if the helmet may have been dropped.
Not switching – auto-lens stays light and will not darken when welding.	Stop welding immediately: Make sure the auto-lens power is turned ON. If power is on, review the sensitivity recommendations and adjust sensitivity. Clean lens cover and sensors of any obstructions. Make sure the sensors are facing the arc, angles of 45° or more may not allow the arc light to reach the sensors.
Not Switching – auto-lens stays dark after the weld arc is extinguished, or the auto-lens stays dark when no arc is present.	Fine-tune the sensitivity setting by making small adjustments to the control by turning it toward the “Low” setting. In extreme light conditions, it may be necessary to reduce the surrounding light levels.
Sections of the auto-lens are not going dark, distinct lines separate the light and dark areas.	Stop welding immediately: The auto-lens may be cracked which can be caused by the impact of dropping the helmet. Weld spatter on the auto lens may also cause cracking. (The lens may need to be replaced, most cracked lenses are not covered by warranty).
Switching or Flickering – the auto-lens darkens then lightens while the welding arc is present.	Review the sensitivity setting recommendations and increase the sensitivity if possible. Make sure that the arc sensors are not being blocked from direct access to the arc light. Check the lens cover for dirt and spatter that may be blocking the arc sensors.
Inconsistent or lighter auto-lens shading in the dark-state, noticeable on the outside edges and corners.	Referred to as an angle of view effect, auto-darkening lenses have an optimum viewing angle, perpendicular, 90° to the surface of the auto-lens. When that angle of view varies in the dark-state, welders may notice slightly lighter areas at the outside edges and the corners of the lens. This is normal and does not represent any health or safety hazard. This effect may also be more noticeable in applications where magnifying lenses are used.

## SECTION 7 – LIMITED WARRANTY

*Effective December 1, 2005*

**LIMITED WARRANTY** – Subject to the terms and conditions below. Hobart Welding Retail, Appleton, Wisconsin, warrants to its original retail purchaser that the new Hobart equipment sold after the effective date of this limited warranty is free of defects in material and workmanship at the time it is purchased at the retailer. THIS WARRANTY IS EXPRESSLY IN LIEU OF ALL OTHER WARRANTIES, EXPRESS OR IMPLIED, INCLUDING THE WARRANTIES OF MERCHANTABILITY AND FITNESS.

Hobart auto-darkening lens helmets are warranted for two (2) years from the date of purchase. **Proof of purchase is required for warranty transactions so it is imperative that a copy of the original invoice or sales receipt be retained.**

**For warranty transactions, contact your original Hobart retailer.**

## SECTION 8 – REPLACEMENT PARTS

Item No.	Description	Stock No.
1*	Kit, Lens Cover Flat Black	770425
	Kit, Lens Cover Gloss Black	770426
	Kit, Lens Cover Patriot (Blue)	770452
	Kit, Lens Cover Red Rivet	770453
	Kit, Lens Cover Blaze Orange	770454
2	Replacement XTF Lens	770455
	Replacement XTV Lens	770427
	Replacement XTP Lens	770238
3	Ratchet Headgear Assembly	770433
4	Magnifying Welding Lens 150X	770274
	Magnifying Welding Lens 175X	770275
	Magnifying Welding Lens 200X	770276
	Magnifying Welding Lens 250X	770277

\* Kit includes: Bezel, 1 front lens cover gasket, 5 front lens covers, 2 inside lens covers.

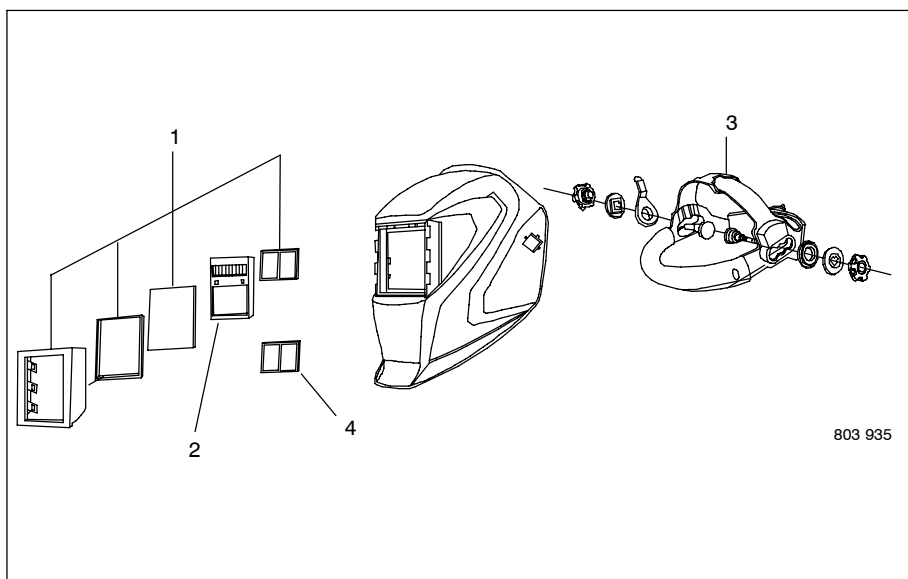

803 935







Visit our website at  
**[www.HobartWelders.com](http://www.HobartWelders.com)**



Hobart Welders  
1635 West Spencer Street  
Appleton, WI 54914 USA  
Phone: 800-332-3281