

45-0544
586 63 67-02

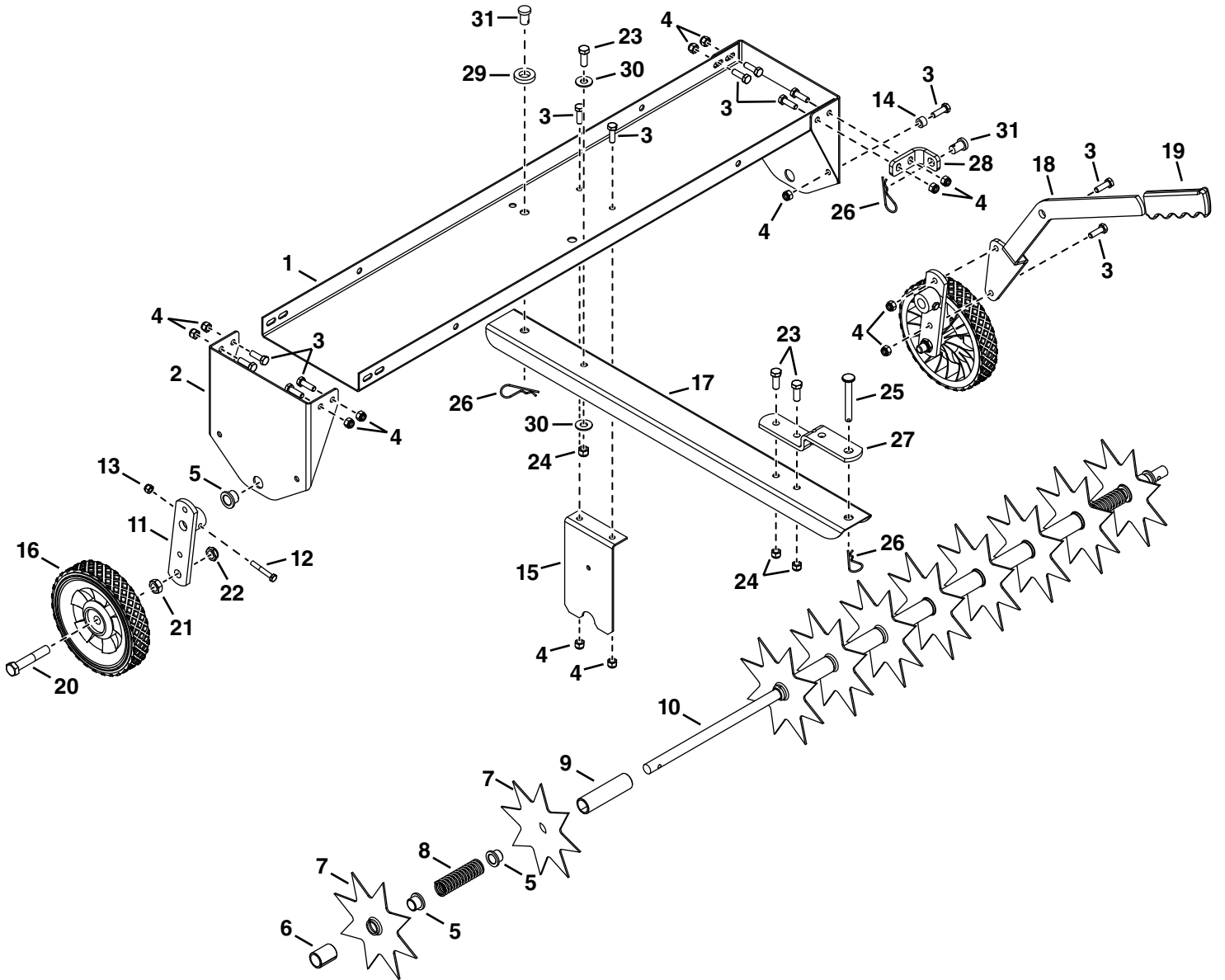

45-0544

REF.	PART NO.	QTY.	DESCRIPTION	REF.	PART NO.	QTY.	DESCRIPTION
1	28304	1	Spiker Plate	17	28305	1	Drawbar
2	28303	2	End Plate	18	28306	1	Wheel Lift Handle
3	43063	13	Hex Bolt, 5/16 x 1"	19	43943	1	Grip
4	47810	13	Nylock Nut, 5/16"	20	43510	2	Hex Bolt, 1/2" x 2-3/4"
5	741-0249	12	Flanged Bearing	21	43019	2	Hex Jam Nut, 1/2"
6	44494	2	Spacer, 0.8" x 1"	22	48115	2	Nylock Jam Nut, 1/2"
7	28606	10	Galvanized Steel Spike Disk	23	43001	3	Hex Bolt, 3/8 x 1"
8	47777	2	Compression Spring	24	HA21362	3	Nylock Nut, 3/8"
9	45151	7	Spacer, 0.8" x 1" x 3.7"	25	47623	1	Hitch Pin
10	28309	1	Shaft	26	43343	3	Hair Cotter Pin
11	68774	2	Wheel Bracket Assembly	27	23687	1	Hitch Bracket
12	1509-69	2	Hex Bolt, 1/4" x 1-3/4"	28	28308	1	Handle Bracket
13	47189	2	Nylock Nut, 1/4"	29	23520	1	Spacer, 0.6" x 0.25" x 0.25"
14	23727	1	Spacer, 0.31" x 0.56" x 0.36"	30	43070	2	Washer
15	28331	1	Center Brace	31	42842	2	Clevis Pin
16	43021	2	Wheel		45600	1	Owner's Manual

586 63 67-02

REF.	PART NO.	QTY.	DESCRIPTION	REF.	PART NO.	QTY.	DESCRIPTION
1	589 43 79-01	1	Spiker Plate	17	589 43 80-01	1	Drawbar
2	589 43 78-01	2	End Plate	18	589 43 81-01	1	Wheel Lift Handle
3	531 00 74-26	13	Hex Bolt, 5/16 x 1"	19	506 62 64-01	1	Grip
4	522 75 16-01	13	Nylock Nut, 5/16"	20	589 43 75-01	2	Hex Bolt, 1/2" x 2-3/4"
5	589 43 77-01	12	Flanged Bearing	21	586 80 63-01	2	Hex Jam Nut, 1/2"
6	531 00 81-04	2	Spacer, 0.8" x 1"	22	586 80 70-01	2	Nylock Jam Nut, 1/2"
7	589 43 72-01	10	Galvanized Steel Spike Disk	23	506 62 49-01	3	Hex Bolt, 3/8 x 1"
8	588 99 19-01	2	Compression Spring	24	501 33 27-01	3	Nylock Nut, 3/8"
9	589 43 76-01	7	Spacer, 0.8" x 1" x 3.7"	25	531 00 81-18	1	Hitch Pin
10	589 43 83-01	1	Shaft	26	522 75 20-01	3	Hair Cotter Pin
11	589 43 85-01	2	Wheel Bracket Assembly	27	531 00 27-72	1	Hitch Bracket
12	577 15 84-01	2	Hex Bolt, 1/4" x 1-3/4"	28	589 43 82-01	1	Handle Bracket
13	522 75 44-01	2	Nylock Nut, 1/4"	29	581 73 71-01	1	Spacer, 0.6" x 0.25" x 0.25"
14	501 34 69-01	1	Spacer, 0.31" x 0.56" x 0.36"	30	734 11 72-01	2	Washer
15	589 43 84-01	1	Center Brace	31	501 34 11-01	2	Clevis Pin
16	504 06 10-01	2	Wheel		45600	1	Owner's Manual