

ASSEMBLY INSTRUCTIONS

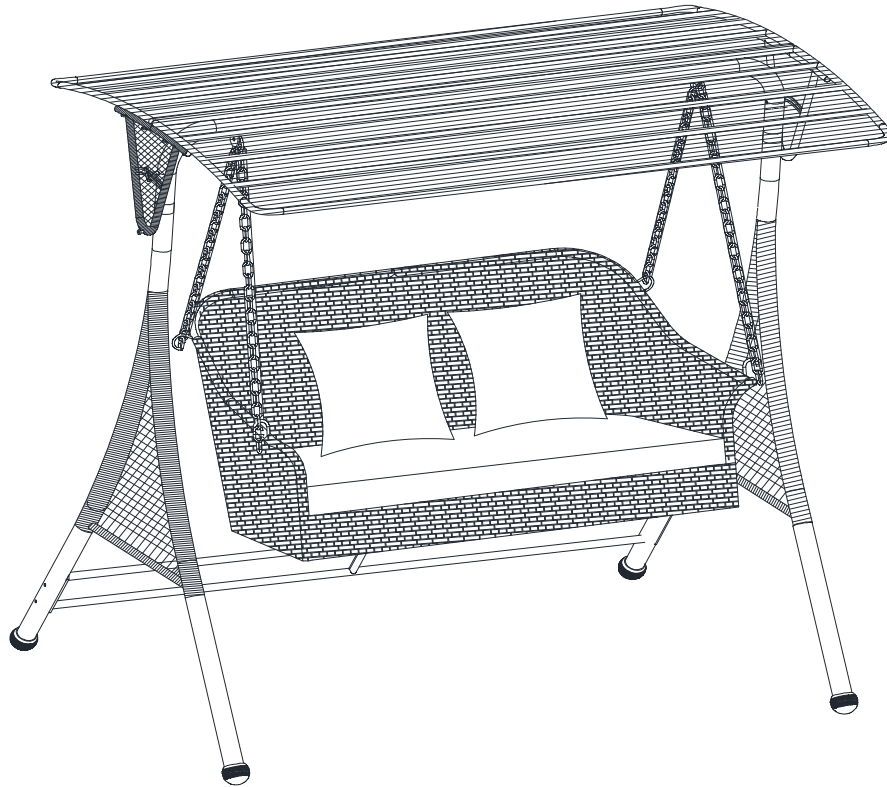







ITEM# :S-DNC1259PST

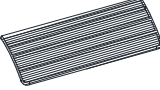

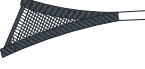

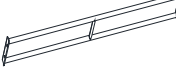









Warning

- Some parts may contain sharp edges. When assembling and using this product, basic safety precautions should always be followed to reduce the risk of personal injury and damage to the product. Please read all instructions before assembly and use.
- Check all bolts for tightness before use, and periodically check and tighten bolts as necessary.

Important: For technical assistance on assembly or replacement parts, please call Sunjoy Industries at 1(866) 578-6569 from 8:00 AM EST to 8:00 PM PST. You may email to customer.care@sunjoygroup.com or visit www.sunjoyonline.com to place your order or fax your parts replacement order form (which is included in the packaging) together with your purchase receipt to 1 (740) 283-3549 for assistance.

PARTS LIST			
Label	Description	QTY	Image of Part
A	Top connection	2	
B	Canopy	2	
C	Top support	1	
D	Foot side connection	2	
E	Back leg	2	
F	Front leg	2	
G	Foot back connection	1	
H	Seat	1	
I	Cushion	1	
J	Pillow	2	

HARDWARE PACK			
Label	Description	QTY	Image of Part
AA	Chain 1	2	
BB	Chain 2	2	
CC	Screw combination M8x70	2	
DD	Knob	2	
EE	Screw combination M6x80	2	
FF	Screw combination M6x50	1	
GG	Screw combination M6x60	4	
HH	Screw combination M6x35	8	
II	Plastic slider	2	
JJ	Hook	2	
KK	Wrench M6	1	
LL	Allen Key M6	1	

ASSEMBLY STEPS

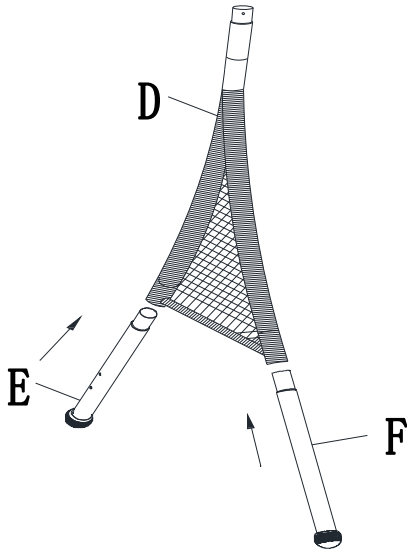

Step 1: Insert Front leg (F), Back leg (E) into Foot side connection (D).

Step 2: Insert Top support (C) into Foot side connection (D), attach Foot back connection (G) and Back leg (E) with Screw combination (GG).

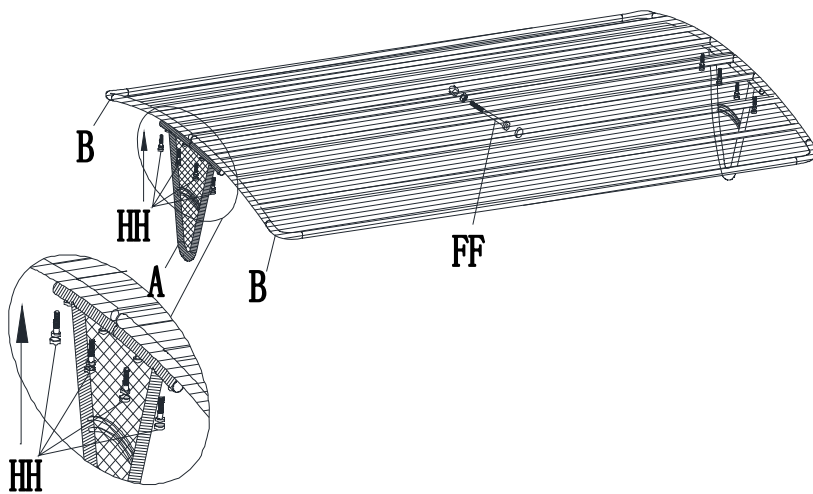
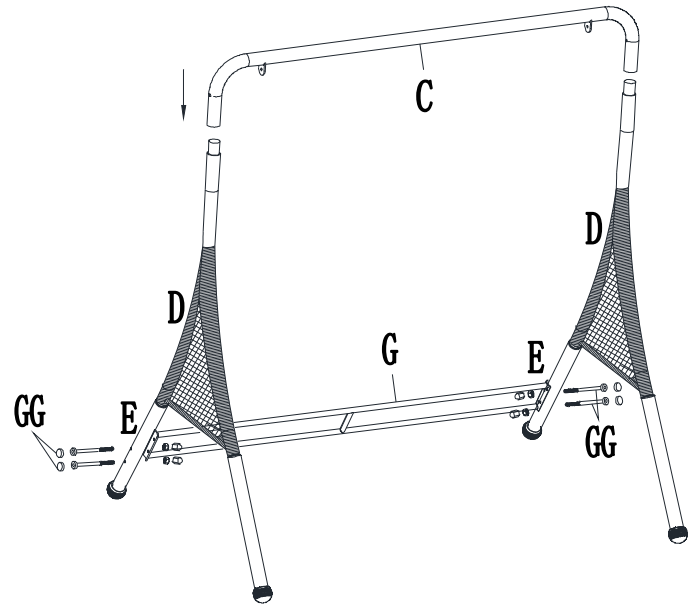

Step 3: Attach Canopy (B) with Screw combination (FF). Attach Top connection (A) and Canopy (B) with Screw combination (HH).

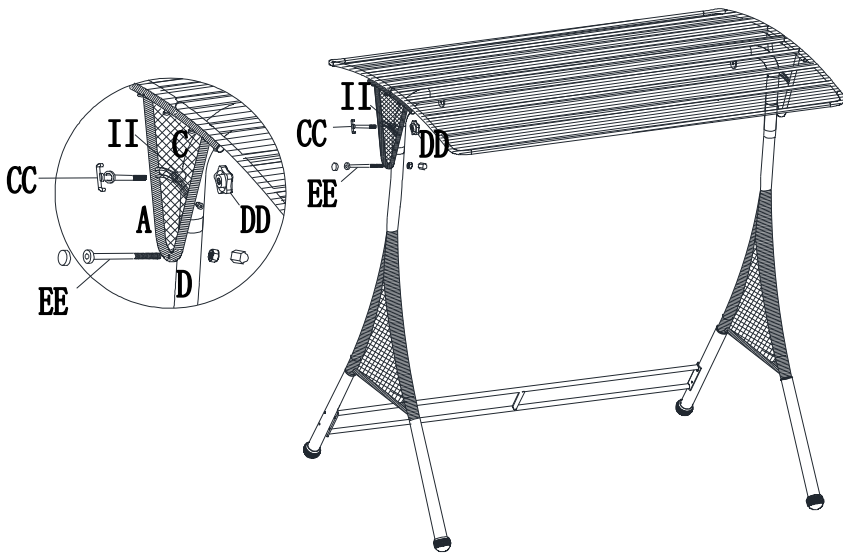

Step 4: Attach Top connection (A) and Foot side connection (D) with Screw combination (EE). Attach Top connection (A) and Top support (C) with Screw combination (CC), Plastic slider (II), Knob (DD).

Step 5: Put Chain 1(AA) and Chain 2 (BB) hang on the Seat (H). Attach Chain 1(AA) and Chain 2 (BB) by Hook (JJ).

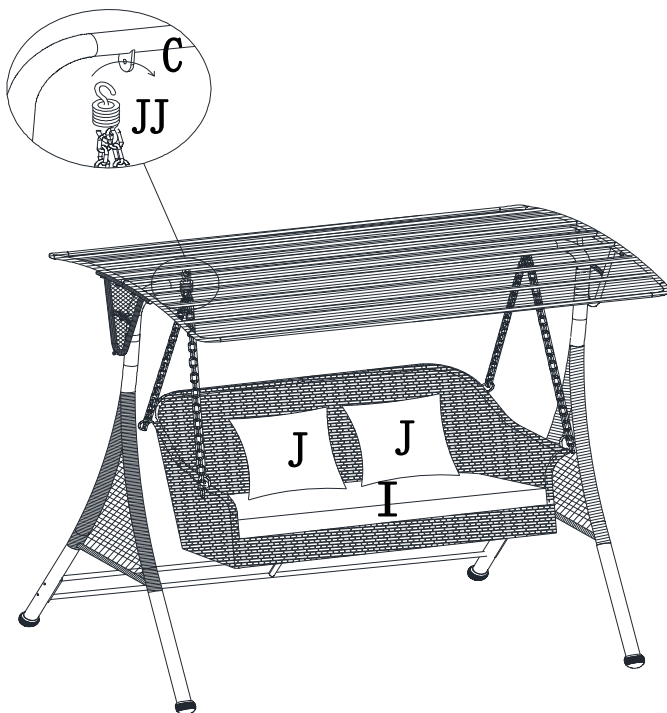
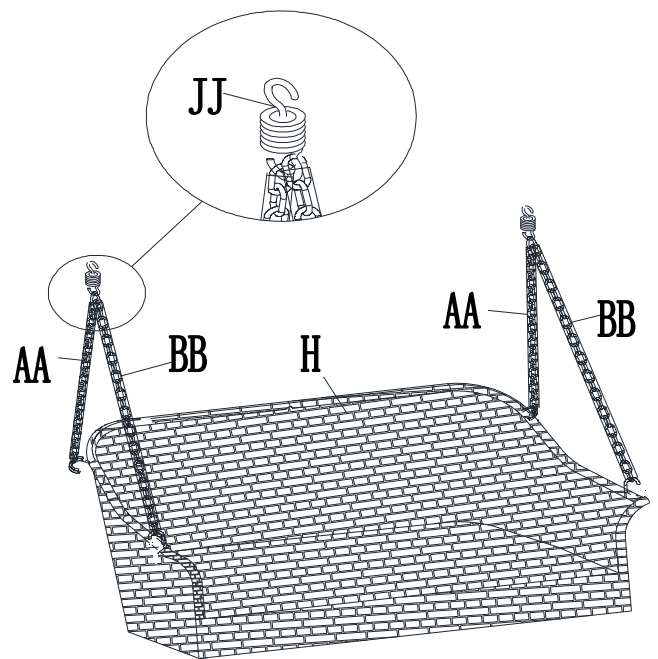

Step 6: Hang Hook (JJ) on Top support (C), put Cushion (I) and Pillow (J) on Seat (H).

Care & Maintenance:

- Before using, clean the product completely with a soft dry towel.
- When not in use, wipe free of any dirt or loose objects, wash with a mild solution of soap and water; rinse thoroughly and dry completely. Do not use strong detergent or abrasive cleaners.
- Steel components of garden accessories and furniture are treated with rust inhibiting paint. However, due to the nature of steel, surface oxidation (rusting) will occur if this protective coating is scratched.
- To minimize this condition, it is recommended that care be taken when assembling and handling the product, in order to prevent the paint from being scratched.

Limited Warranty: The item is warranted to be free from defects in material or workmanship for a period of twelve (12) months. However, we do not reimburse for transportation or delivery costs, nor compensate the individual or any outside party for assembling or disassembling the product. This limited warranty is extended to the original purchaser and applies to defects in materials and workmanship of your item, provided the item is maintained with care and used only for personal residential purposes.

Exclusions

Items used for commercial, contract, or other non-residential purposes, or items damaged due to acts of nature, vandalism, misuse, or improper assembly are not covered. Corrosion or rusting of hardware is not covered. Proof of purchase (dated register receipt) is required for warranty claims. Warranty is to the original purchaser and is non-transferable. Any replacement of warranted items will be in the original style and color or a similar style and color if the original is unavailable or has been discontinued. As some states do not allow exclusions or limitations on an implied warranty, the above exclusions and limitations may not apply. This warranty gives you specific rights, and you may also have other rights, which vary from state to state.