

# Assembly Instructions

## D-DN1656SST Chair

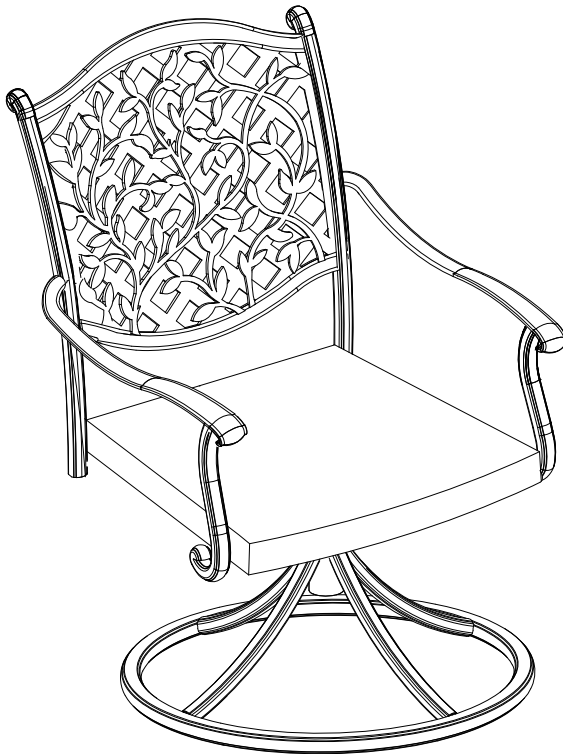













### **Warning**

- Some parts may contain sharp edges. When assembling and using this product, basic safety precautions should always be followed to reduce the risk of personal injury and damage to the product. Please read all instructions before assembly and use.
- Check all bolts for tightness before use, and periodically check and tighten bolts as necessary.

**Important:** For technical assistance on assembly or replacement parts, please call Sunjoy Industries at 1(866) 578-6569 from 8:00 AM EST to 8:00 PM PST or email to [customer.care@sunjoygroup.com](mailto:customer.care@sunjoygroup.com) or visit [www.sunjoyonline.com](http://www.sunjoyonline.com) to place your order or fax your parts replacement order form together with your purchase receipt to 1-740-283-3549 for assistance.

**Limited Warranty:** The item is warranted to be free from defects in material or workmanship for a period of **12** Months. However, we don't reimburse for transportation or delivery costs, or compensate the individual or any outside party for assembling or disassembling the product. This limited warranty is extended to the original purchaser and applies to defects in materials and workmanship of your item, provided the item is maintained with care and used only for personal residential purposes.

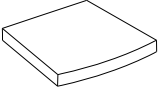
Parts List			
Part#	Description	Qty.	Image
A	Chair seat	1	
B	Chair base	1	
C	Foot cap (Pre-assembled on Part B)	8	
D	Bolt M8x40	4	
E	Nut M8 (4 pre-assembled on Part H)	8	
F	Spring washer M8 (4 pre-assembled on Part H)	8	
G	Flat washer M8 (4 pre-assembled on Part H)	8	
H	T-shape support (Pre-assembled on Part B)	1	
I	Square plate (2 pre-assembled on Part H)	6	
J	Metal piece (Pre-assembled on part H)	2	
K	Bolt M8x35 (Pre-assembled on Part H)	4	
L	Foot pad (Pre-assemble on Part B)	1	
M	Wrench	2	
N	Cushion	1	

## Assembly Steps

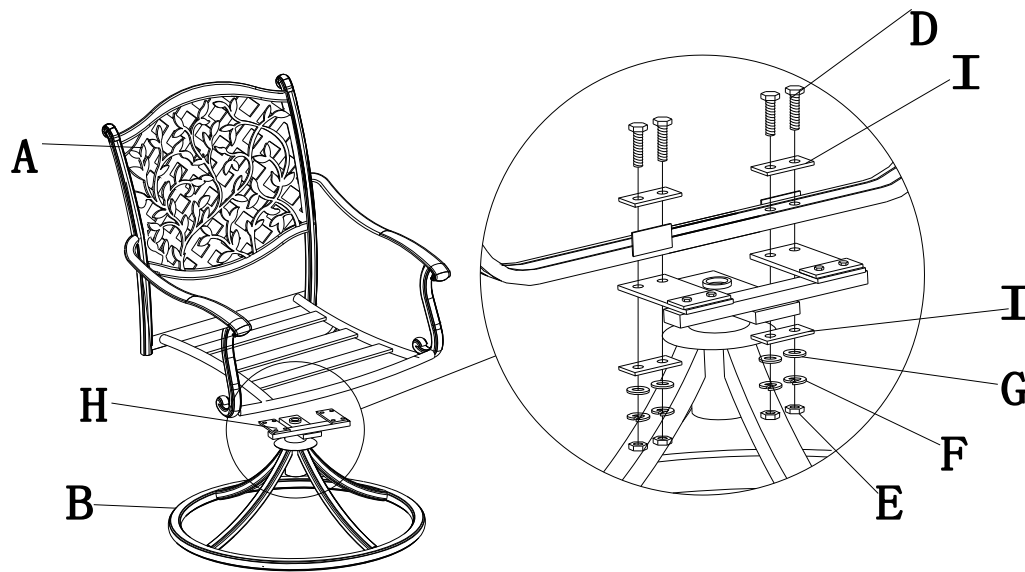

**Step 1:** Align the assembly holes on T-shape support (H) and Chair seat (A) and attach them with Bolt (D), Square plate (I), Flat washer (G), Spring washer (F) and Nut (E). Use Wrench (M) to tighten all the bolts.

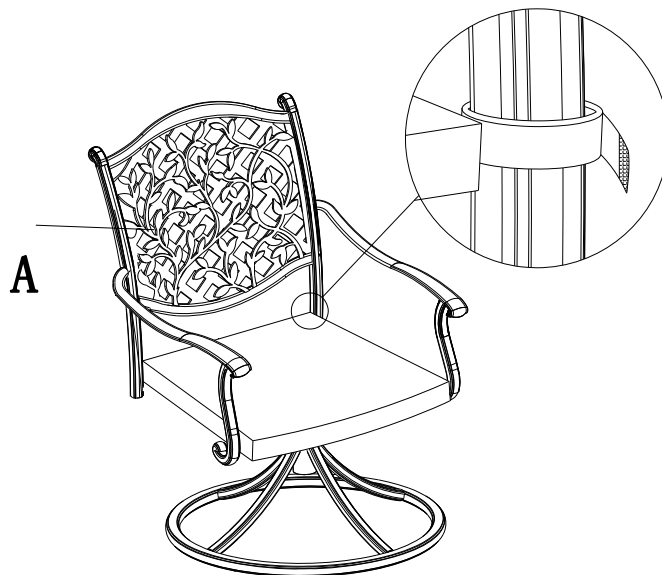

**Step2:** Put Cushion (N) on the assembled Chair seat (A), fasten the hook and loop.

# Assembly Instructions

## D-DN1656SST Table













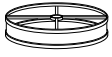

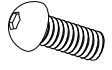
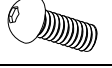

### **Warning**

- Some parts may contain sharp edges. When assembling and using this product, basic safety precautions should always be followed to reduce the risk of personal injury and damage to the product. Please read all instructions before assembly and use.
- Check all bolts for tightness before use, and periodically check and tighten bolts as necessary.

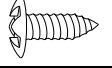
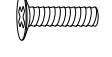
**Important:** For technical assistance on assembly or replacement parts, please call Sunjoy Industries at 1(866) 578-6569 from 8:00 AM EST to 8:00 PM PST or email to [customer.care@sunjoygroup.com](mailto:customer.care@sunjoygroup.com) or visit [www.sunjoyonline.com](http://www.sunjoyonline.com) to place your order or fax your parts replacement order form together with your purchase receipt to 1-740-283-3549 for assistance.

**Limited Warranty:** The item is warranted to be free from defects in material or workmanship for a period of **12** Months. However, we don't reimburse for transportation or delivery costs, or compensate the individual or any outside party for assembling or disassembling the product. This limited warranty is extended to the original purchaser and applies to defects in materials and workmanship of your item, provided the item is maintained with care and used only for personal residential purposes.

Parts List			
Part#	Description	Qty.	Image
A	Table Top	1	
B	Leg	4	
C	Connecting frame	1	
D	Flat washer M8	8	
E	Spring washer M8	8	
F	Bolt M8x20	8	
G	Bolt M6 x 40	8	
H	Flat washer M6	8	
I	Spring washer M6	8	
J	Foot Pad (Pre-assemble on Part# B)	4	
K	Allen Wrench M6	1	
L	Allen Wrench M8	1	
M	Screw M5 x10 (Pre-assembled on Part# Q)	4	
N	Bolt M5 x20 (Pre-assembled on Part# Q)	4	
O	Lazy Susan	1	
P	Umbrella hole cap	1	
Q	Lazy Susan Ring (Pre-assembled on Part# O)	1	

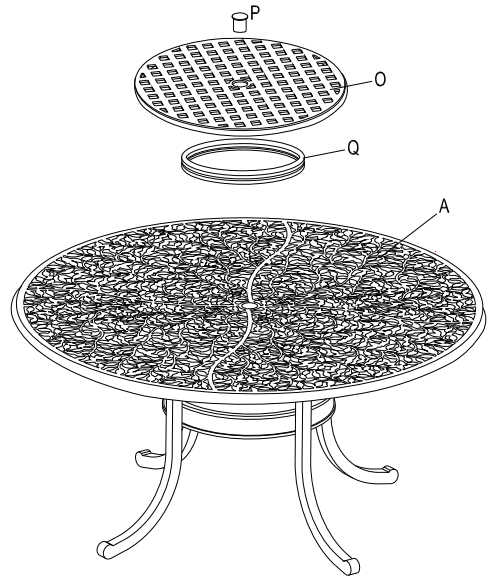
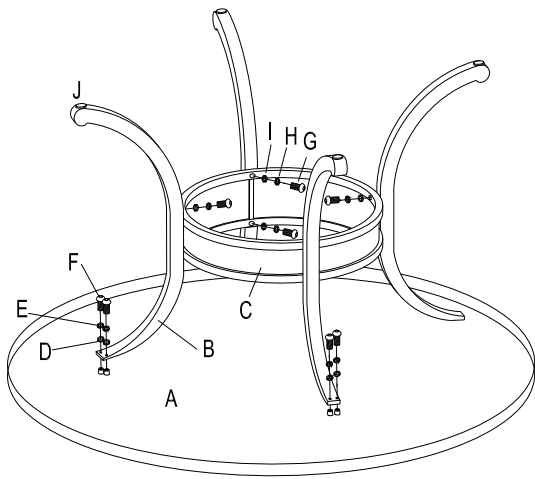

1. Attach the Connecting frame (C) to Leg (B) with Bolt (G), Spring washer (H), and Flat washer (I) by using M6 Allen wrench (K). Do not tighten them up at this step.
2. Attach the Table top (A) to the Leg (B) with Bolt (F), Spring washer (E), and Flat washer (D) by using Allen wrench (L).
3. Tighten all hardware, and turn upside the assembled table.
4. Place Lazy Susan top (O) on the table top, insert Umbrella hole cap (P) into Lazy Susan top (Q) and the table top.

**Now your table is ready for use.**