

Assembly Instructions

Item #: L-GZ605PST-A4

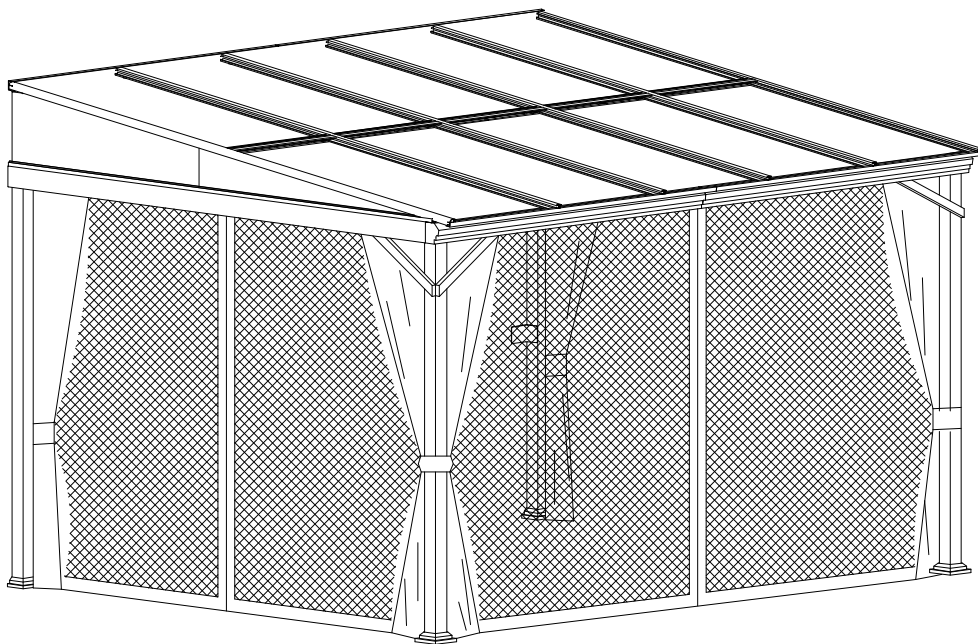

IMPORTANT

Thank you very much for choosing Sunjoy Industries.

Please take time to read these instructions thoroughly and follow each step carefully for safe and easy operation. Keep this manual for future reference.

We would like to hear from you with any comments or suggestions. You can call us toll-free at 1-866-578-6569 anytime 24 hours / 7 days a week. You can also send the email to amazon@sunjoygroup.com or visit www.sunjoyonline.com to get tech. assistance or to place your replacement part order form.

Production Number: 20183572

Cautions:

1. Keep all children and pets away from assembly area. Children and pets should be supervised when they are in the area of pavilion construction.
2. The area for assembly should not be less than 6 feet from any obstruction such as fence, garage, house, over hanging branches, laundry line or electrical wires.
3. This unit is heavy. Do not assemble this item alone. Six people are recommended for safe assembly.
4. Some parts may contain sharp edges. Wear protective gloves if necessary during assembly.
5. When assembling and using this product, basic safety precautions should always be followed to reduce the risk of personal injury and damage to equipment. Please read all instructions before assembly and use.
6. For outdoor use only. Install on level ground. 16 stakes are provided to secure the pavilion in the ground. If you wish to secure the pavilion to a wood deck or concrete surface, you will need to purchase fasteners appropriate for these surfaces. These are readily available at your local hardware store or home center.
7. Check all bolts for tightness before and during usage.
8. Please check your state and local regulations prior to purchasing. Some jurisdictions may require permits for, or otherwise regulate, installation and use.
9. While this pavilion is manufactured to withstand gale force winds utilizing only the supplied ground stakes, in areas subject to frequent severe weather, securing the pavilion to a deck, concrete patio or footings should be considered.
10. Your pavilion has been engineered to accommodate winter snow loads incurred in most areas. Removal of accumulated snow on the pavilion roof with a roof rake is recommended. In areas that are regularly subject to blizzard conditions however, removal of the roof panel is suggested. The assembled roof structure can simply be left intact until warmer conditions return.

Assembly Instructions:







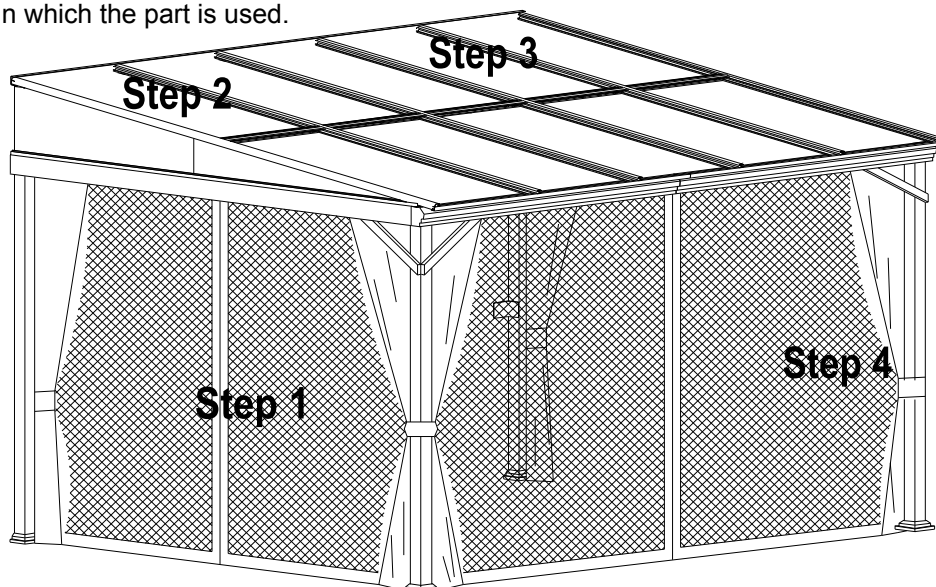

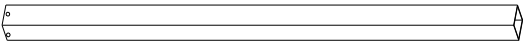
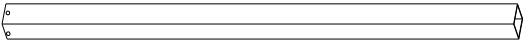

Our clear, easy-to-follow, step-by-step instructions will guide you through the project from start to finish. The final product will be a quality piece that will go together smoothly and give years of enjoyment.

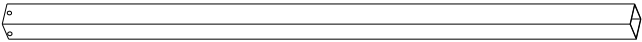
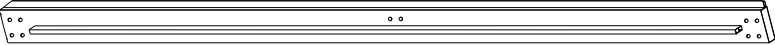
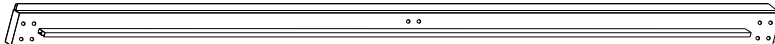
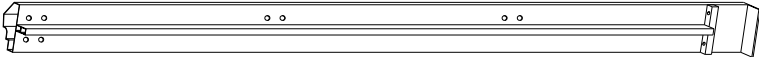
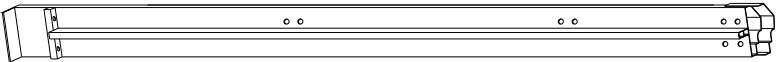
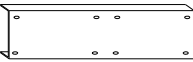

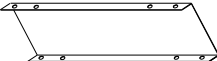

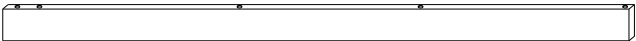

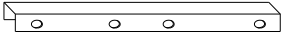

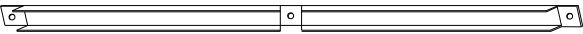



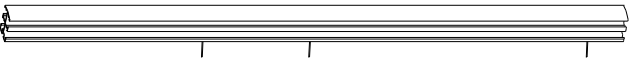



All you need a screwdriver and hammer, two ladders (not included) whose height is no less than 2.5m.

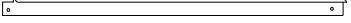
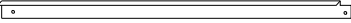





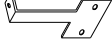

Parts identification: For ease of identification, all parts are labeled to correspond to the Step number in which the part is used.





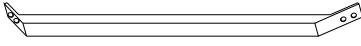
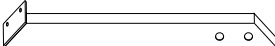

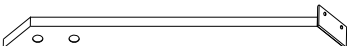
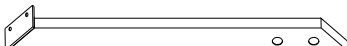

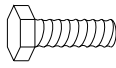

Parts List

Front post 1	A1	1	
Front post 2	A2	1	
Back post 1	A3	1	
Back post 2	A4	1	
Side beam 1	B1	1	
Side beam 2	B2	1	
Decorative slot 1	C1	1	
Decorative slot 2	C2	1	
Junction bar	D	1	
Back beam 1	E1	1	
Back beam 2	E2	1	
Beam junction	F	2	
Middle beam 1	G1	1	
Middle beam 2	G2	1	
Small beam 1	H1	2	
Small beam 2	H2	2	
Small beam junction	I	2	
Back card slot 1	J1	1	
Back card slot 2	J2	1	
Front card slot 1	K1	2	

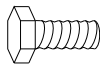
Front card slot 2	K2	1	
Edge beam 1	L1	1	
Edge beam 2	L2	1	
Middle beam	L3	4	
PC panel 1	M1	10	
PC panel 2	M2	1	
PC panel 3	M3	1	
PC panel 4	M4	1	
PC panel 5	M5	1	
PC penal card slot	N	5	
Side card slot 1	N1	1	
Side card slot 2	N2	1	
Post base 1	O1	2	
Post base 2	O2	2	
Post base cover 1	P1	2	
Post base cover 2	P2	2	
Curtain-mounting tab	Q	4	
Middle beam bracket	R	2	
Connecting piece 1	S1	12	
Connecting piece 2	S2	4	

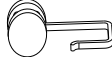
Connecting piece 3	S3	1	
Connecting piece 4	S4	1	
Bracket 1	T1	1	
Bracket 2	T2	1	
Bracket 3	T3	4	
Corner support	U	2	
Sidestay1	V1	2	
Sidestay2	V2	2	
Sidestay3	V3	1	
Sidestay4	V4	1	
Curtain	W	1	
Mosquito Net	Y	1	

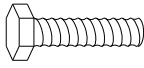
Hardware Pack 1

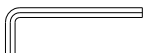
AA	Bolt M6X20	4PCS	
BB	Flat washer M6	74PCS	
CC	Bolt M6X15	38PCS	
DD	Nut M6	2PCS	
EE	Plastic ring	80PCS	
FF	Bolt M6X15	24PCS	
GG	Bolt M6X35	4PCS	
HH	Bolt M6X15	26PCS	
Z1	Wrench M6	2PC	
Z2	Wrench M6	1PC	

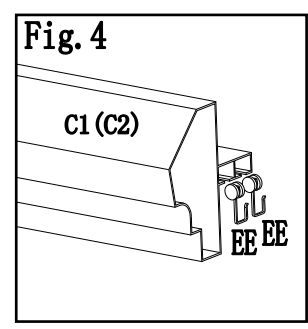
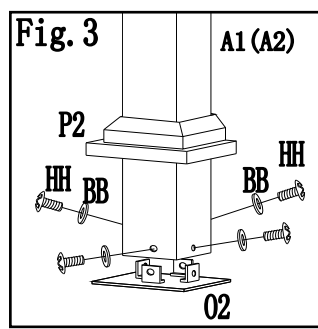
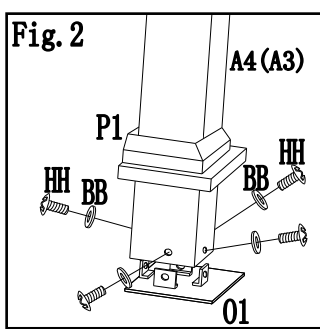
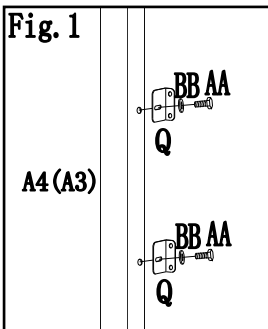
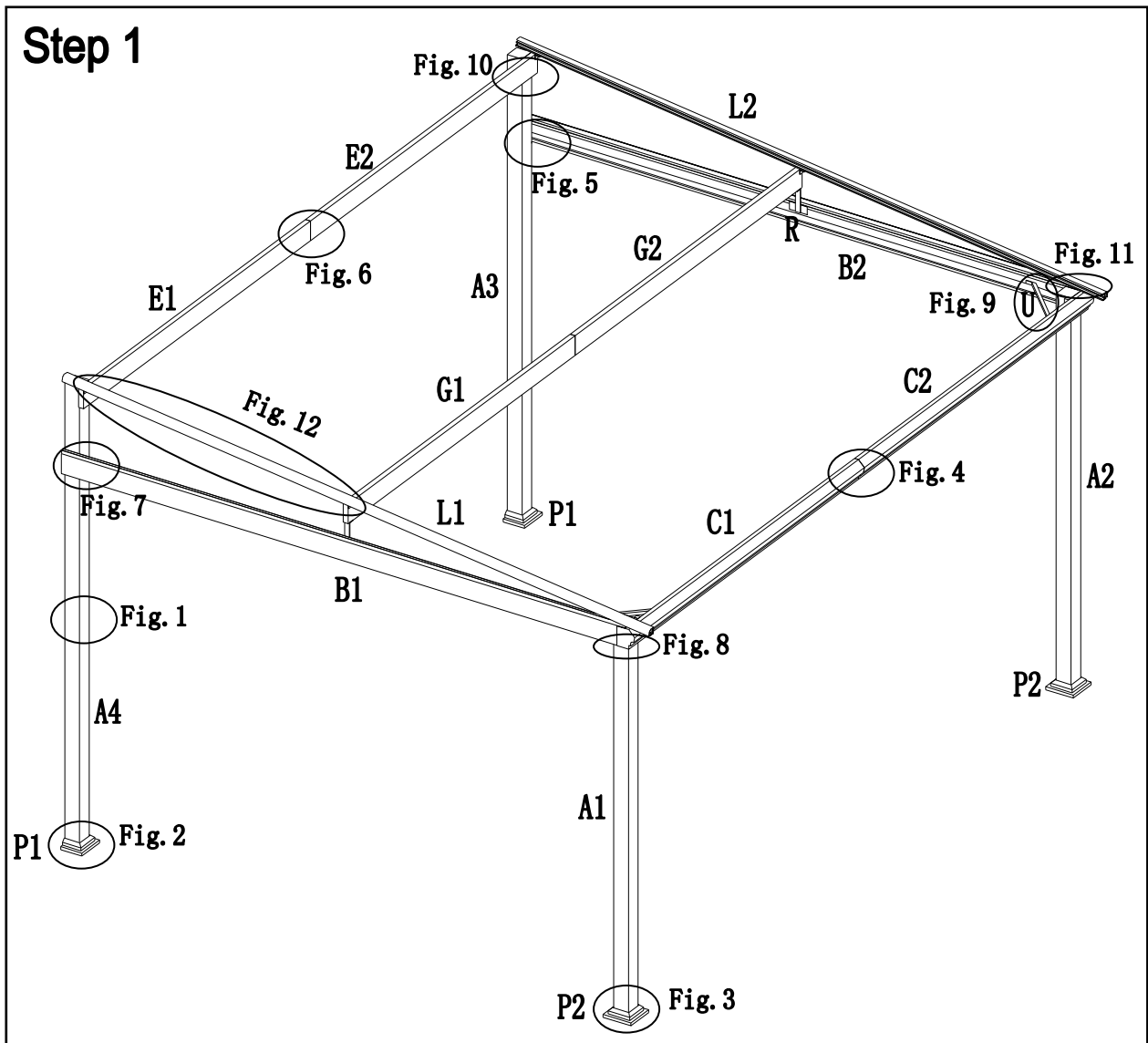

- Fig.1:** Install the curtain-mounting tab (Q) to back post 1 (A3) and back post 2 (A4) with bolt (AA) and flat washer (BB). Ensure the narrow surface of the curtain-mounting tab (Q) faces the post with three holes.
- Fig.2:** Set the post base cover 1 (P1) into the back post 1 (A3) and back post 2 (A4), then secure post base cover 1 (O1) to post 4 (A4) and post 3 (A3) with a bolt (HH) and flat washer (BB). Ensure the flat surface of the base 1 (O1) and post base cover 1 (P1) face the post with three holes.
- Fig.3:** Set the post base cover 2 (P2) to the front post 1 (A1) and front post 2 (A2), then secure the post 2 (O2) to front post1 (A1) and front post 2(A2) by using bolt (HH) and flat washer (BB).
- Fig.4:** Install the plastic rings (EE) into decorative slot 1 (C1) and decorative slot 2 (C2), use 8 plastic rings for each decorative slot.

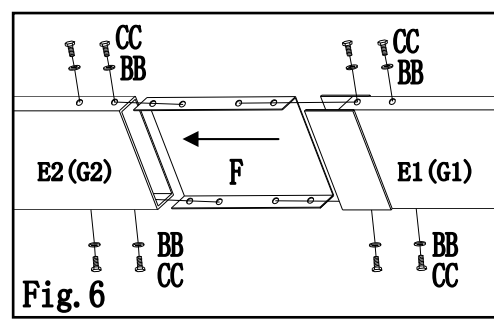
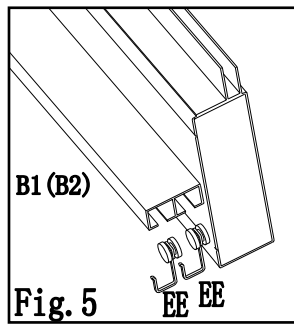
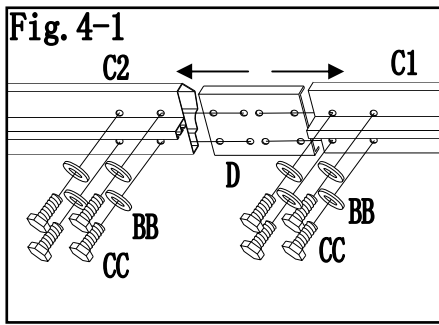

Fig.4-1: Insert the junction bar (D) into the decorative slot 1(C1) and decorative slot 2 (C2), and secure with bolt (CC) and flat washer (BB).

Fig.5: Install the plastic rings (EE) into the runner of side beam 1 (B1) and side beam 2 (B2), 12 plastic rings for each runner. There are 2 Plastic rings to be each inside corner

Fig.6: Insert the beam junction (F) into back beam 1 (E1) and beam 2 (E2) and secure with bolt (CC), and flat washer (BB). Install the middle beam 1 (G1) and middle beam 2 (G2) in the same way with back seam1 (E1) and back seam2 (E2).

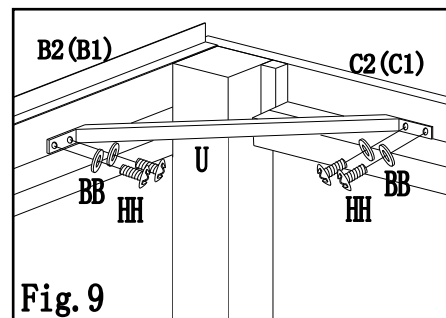
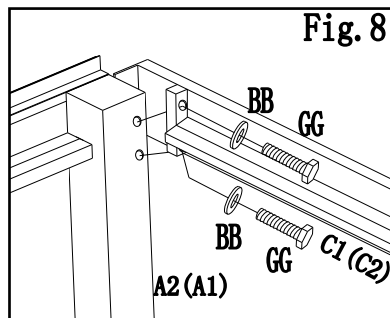
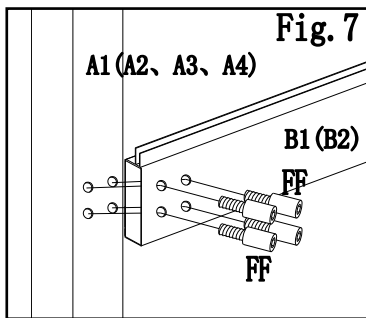

Fig.7: Use bolts (FF) to install the complete side beam 1(B1) (or side beam 2(B2)) to front post 1 (A1) and back post2 (A4)(or front post 2(A2) and back post 1(A3))

Fig.8: Install the complete decorative slot to front post with bolt (GG) and flat washer.

Fig.9: Install the corner support (U) to the corner of front post, and secure them with bolt (HH) and bolt (BB).

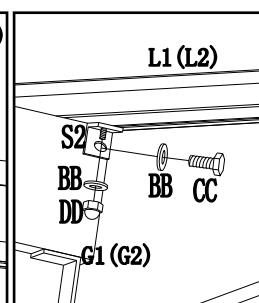
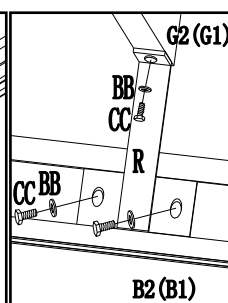
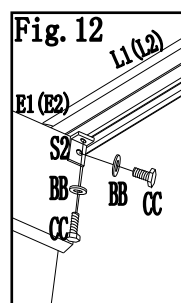
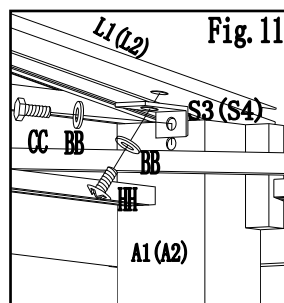
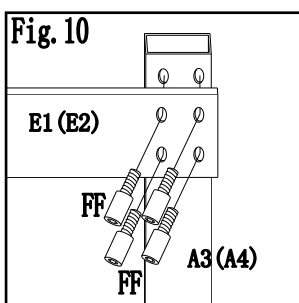





Fig.10: Install the complete back beam to back post with bolt (FF).

Fig.11: Install Connecting piece 3(S3) (or Connecting piece 4(S4)) to Edge beam 1(L1) (or Edge beam 2(L2)) with Bolt (HH) and Flat Washer (BB), then fix assembled boundary beam onto Post 1(A1) (or Post 2(A2)).

Fig.12: Using connecting piece 2(S2), bolt (CC), flat washer (BB) to secure the edge beam 1(L1) (or edge beam 2(L2)) to back seam. Use bolt (CC) and flat washer (BB) to install middle beam mounting bracket (R) and middle beam to side beam. Install connecting piece 2 (S2) to the bolt of edge beam 1(L1) or edge beam 2(L2)'s card slot by using bolt (DD) and flat washer (BB), then use a bolt (CC) and flat washer (BB) to install connecting piece (2) to middle beam.

Hardware Pack 2

BB	Flat washer M6	56PCS	
CC	Bolt M6X15	40PCS	
DD	Nut M6	4PCS	
II	Nut M6	12PCS	

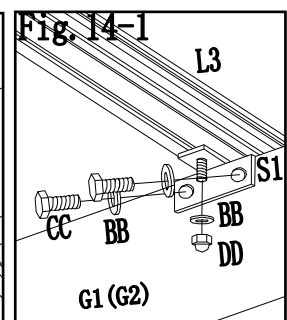
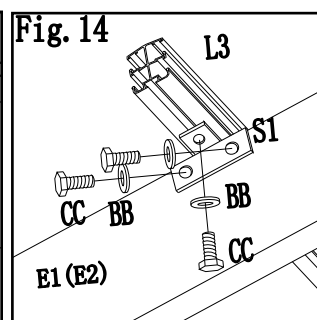
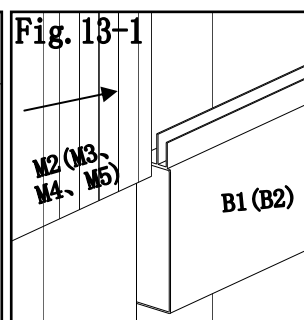
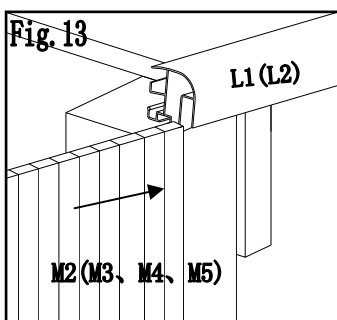
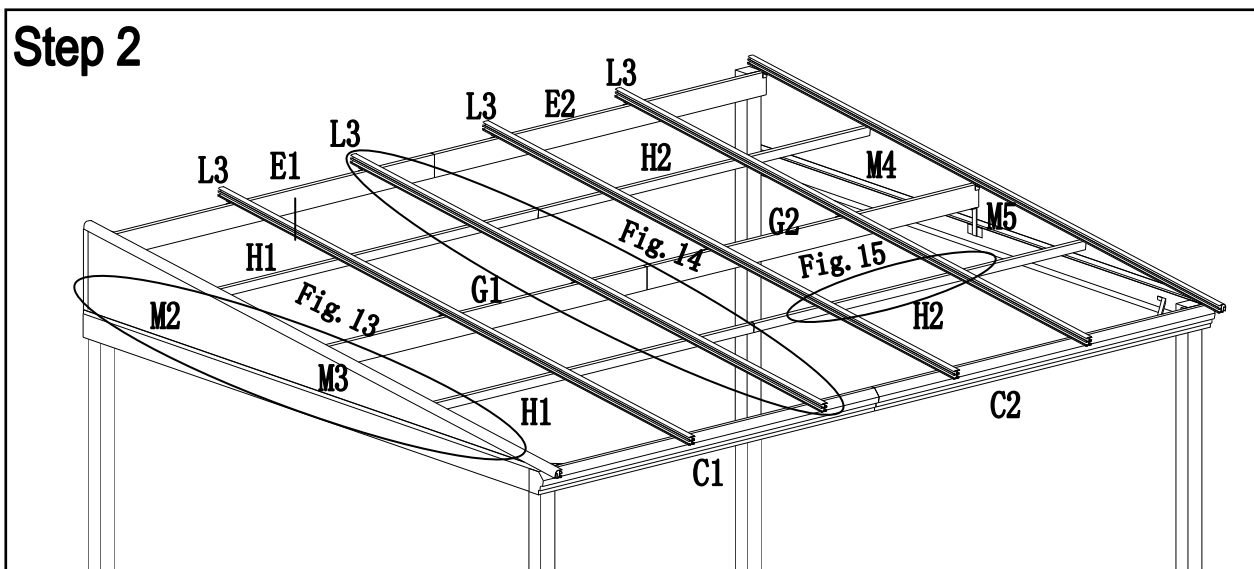

Fig.13, Fig.13-1: Insert the PC panel 3 (M3)(or PC panel 5 (M5)) to the card slot of edge beam and side beam, then insert PC panel 2 (M2)(or PC panel 4(M4)) to the card slot of edge seam and side beam.

Fig.14: Using connecting piece 1 (S1), bolt (CC) and flat washer (BB) to install one side of middle beam (L3) to back beam.

Fig.14-1: Install the connecting piece 1(S1) to the bolt of middle beam (L3)'s card slot by using bolt CC and flat washer BB. Use bolt (CC) and flat washer (BB) to install the connecting piece 2 (S2) to middle beam.

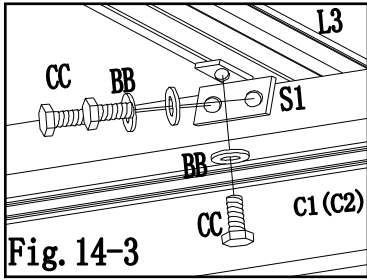

Fig. 14-3

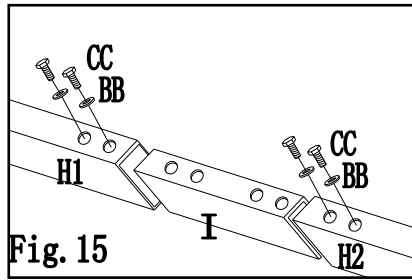

Fig. 15

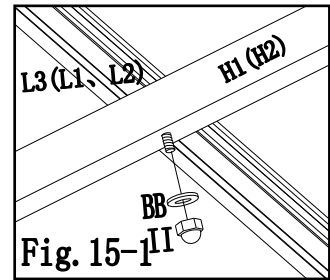

Fig. 15-1

Fig.14-3: Install another side of middle beam (L3) to decorative slot by using connecting piece 1(S1), bolt (CC) and flat washer (BB).

Fig.15: Insert the small beam junction (I) into small beam 1(H1) and small beam 2(H2) and secure them with bolt CC and flat washer BB.

Fig.15-1: Set the complete small beam through the 2 group bolts middle beam (L3) and edge beam(L1) and secure them with nut (II) and flat washer (BB).

Hardware Pack 3

CC	Bolt M6X15	6PCS	
BB	Flat washer M6	16PCS	
HH	Bolt M6X15	4PCS	
DD	Nut M6	6PCS	
JJ	Bolt M6X10	6PCS	

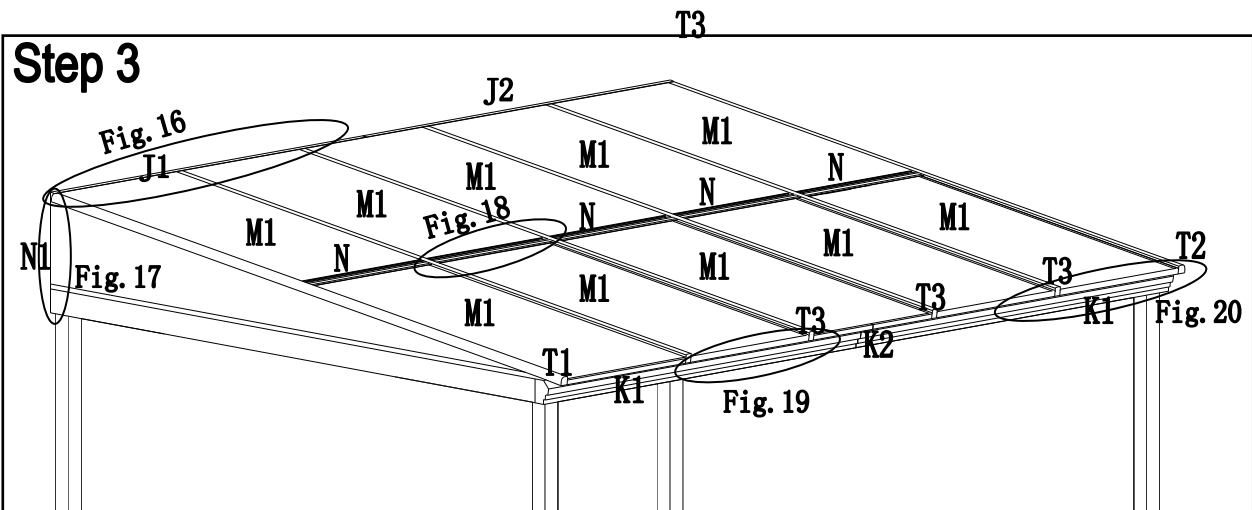

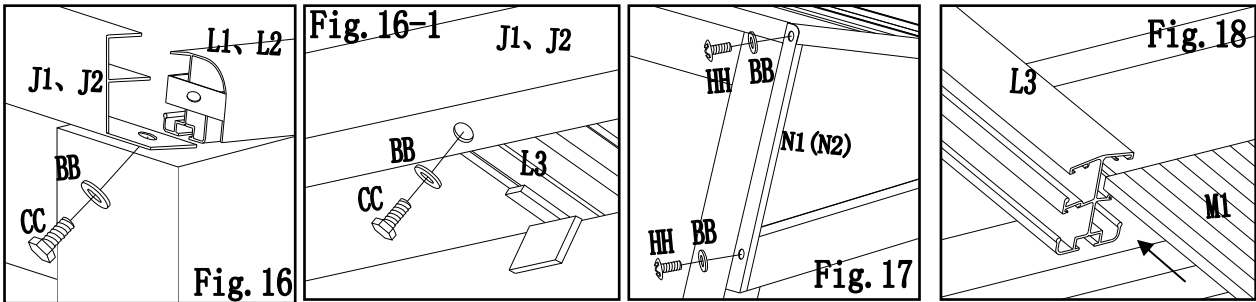

Fig.16: Settle back card slot 1 (J1) and back card slot 2 (J2) to edge beam and middle beam, and secure one side of back card slot to edge beam by using bolt (HH) and flat washer (BB).

Fig.16-1: Fix Back card slot 1(J1) and Back card slot 2 (J2) with Middle beam (L3).

Fig.17: Set the side card slot 1 (N1) and side card slot 2 (N2) to side PC panel, and secure them with bolt HH and flat washer BB.

Fig.18: Insert the PC panel 1(M1) into the slot of middle beam (L3), install the edge beam 1(L1) and edge beam 2(L2) in the same way.

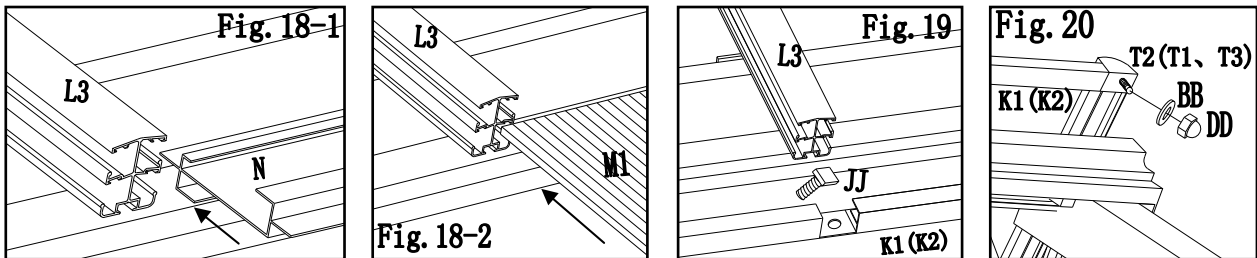

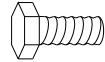

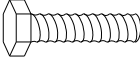
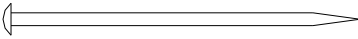

Fig.18-1: Insert the PC panel (N) into the slot of middle beam (L3), install the edge beam1 (L1) and edge beam2 (L2) the same way.

Fig.18-2: Insert PC panel 1(M1) into the bottom card slot of middle beam (L3), install edge beam 1(L1) and edge beam 2(L2) the same way.

Fig.19: Insert the bolt (JJ) into the bottom card slot of middle beam (L3), edge beam 1 (L1) and edge beam 2 (L2), then set the front card slot 1 (K1) to complete bolt (JJ) and insert the front card slot into the PC panel. Install front card slot 2(K2) the same way, see step 3.

Fig.20: Install the blank 2(T2) to edge beam 2(L2) and front card slot 2(K2), and secure them with bolt DD and flat washer BB. Same way to install the blank 1(T1) and blank 3(T3), see step 3.

Hardware Pack 4

CC	Bolt M6X15	12 PCS	
BB	Flat washer M6	24 PCS	
GG	Bolt M6X35	12 PCS	
KK	Nail Φ8X250MM	14 PCS	
LL	Screw M6*80	8 PCS	

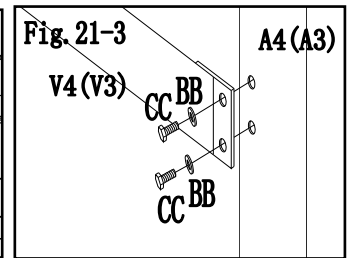
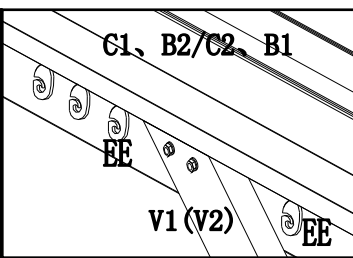
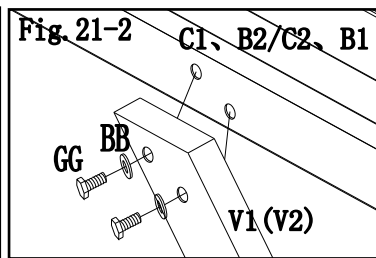
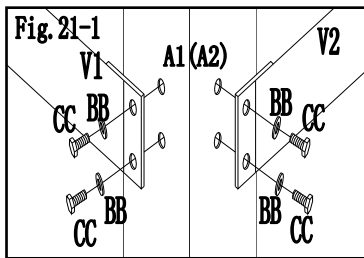
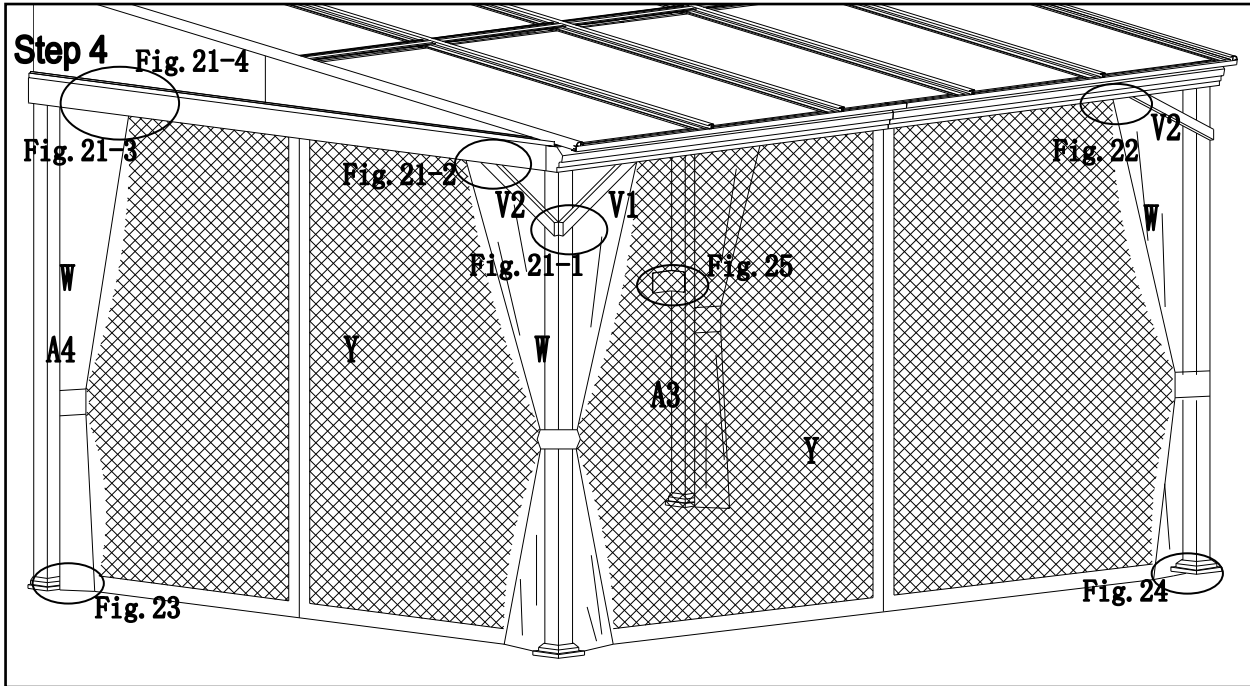

Fig.21-1: Attached Side stay (V1, V2) to Post (A1, A2) with Bolt (CC) and Flat Washer (BB).

Fig.21-2: Slid 1pc Plastic Ring (EE) to be inside of Stay 1(V1), then use Bolt (GG) and Washer (BB) to lock top of Side Stay 1(V1), Decorative slot 1(C1) and Side beam 2(B2) together. Repeat this step, lock Side Stay 2 (V2), Decorative slot 2(C2) and Side beam 1(B1) together.

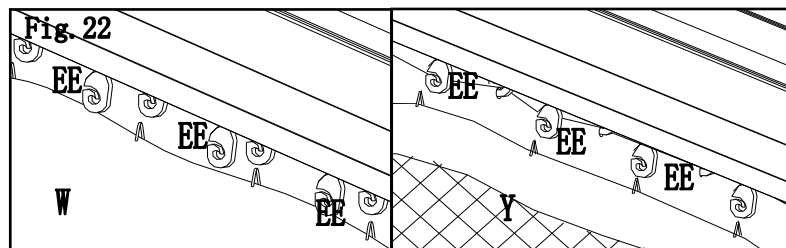
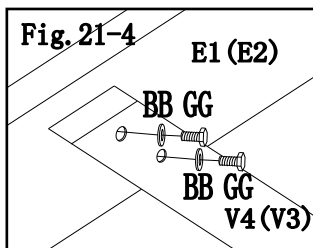

Fig.21-4: Use Bolt (GG) and Washer (BB) to lock Side Stay (V4, V3) onto Back beam (E1, E2).

Fig.22: Hang Curtain (W) on outside line of Plastic Ring (EE), and hang Mosquito Net(Y) on the inside line of Plastic Ring (EE).

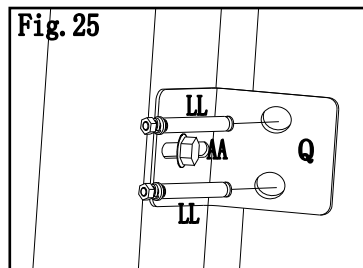
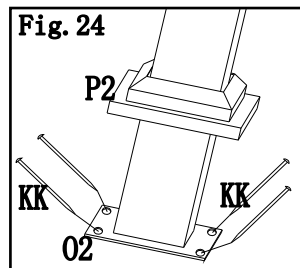
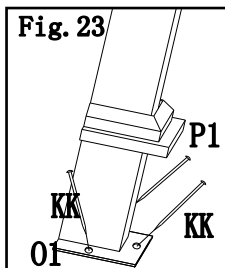

Fig.23: Raise the post base cover 1 (P1) and assemble ground spike (KK) to the ground through the post base 1(O1)

Fig.24: Raise the post base cover 2 (P2) and assemble ground spike (KK) to the ground through the post base 2(O2) .

Fig.25: Secure the gazebo to the curtain by using bolt (LL) through curtain-mounting bracket (Q), and screw the bolts in the curtain-mounting bracket (Q).

Care & Maintenance:

Our steel components for garden accessories and furniture are treated with rust inhibiting paint that protects it from rusting. However, due to the nature of steel, surface oxidation (rusting) will occur once these protective coatings are scratched. This is not a defect and thus not covered by the warranty.

To minimize this condition, we recommend care when assembling & handling the product to prevent scratching the paint. Should any scratching or damage occur, we recommend immediate touch-up with rust inhibiting paint.

Surface rust can also be easily removed with a very light application of any rust removing solution, we also recommend WD-40, which is readily available in all major stores. If no measure is taken to prevent this, the oxidation may start dripping on to deck or patio and caused damaging stains, which may be difficult to remove. This can be prevented if the above-mentioned measures are taken to keep the product from oxidizing.

Limited Manufacturer's Warranty:

This limited warranty is extended to the original purchaser and applies to defects in materials and workmanship of your item provided the item is maintained with care and used only for personal, residential purposes.

The item is warranted to be free from defects in material or workmanship for a period of **one (1) year**. We don't reimburse for transportation or delivery costs, or compensate the individual or any outside party for assembling or disassembling the product.

Exclusions:

Items used for commercial, contract, or other non-residential purposes, or items damaged due to acts of nature, vandalism, misuse, or improper assembly are not covered. Corrosion or rusting of hardware is not covered. Proof of purchase (dated register receipt) is required for warranty claims. Warranty is to the original purchaser and is non-transferable. Any replacement of warranted items will be in the original style and color, or a similar style and color if the original is unavailable or has been discontinued. As some states do not allow exclusions or limitations on an implied warranty, the above exclusions and limitations may not apply. This warranty gives you specific rights, and you may also have other rights, which vary from state to state.

Made in China