

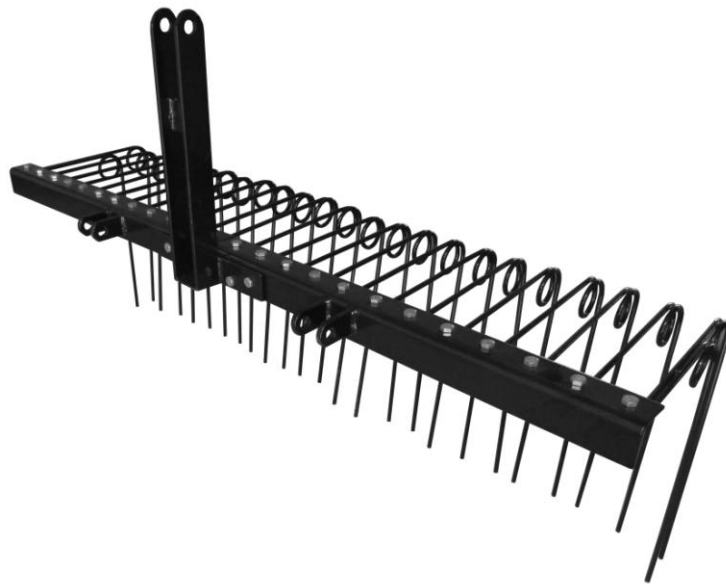

60" 3pt Pine Straw Rake

OWNER'S MANUAL



WARNING:

Carefully read and understand all **ASSEMBLY AND OPERATION INSTRUCTIONS** before operating. Failure to follow the safety rules and other basic safety precautions may result in serious personal injury.

MODEL # FTF-60PSR3PT

Thank you very much for choosing this product! For future reference, please complete the owner's record below:

Model: _____ Purchase Date: _____

Save the receipt, the warranty, and these instructions. It is important that you read the entire manual to become familiar with this product before you begin using it.

This product is designed for certain applications only. The manufacturer cannot be responsible for issues arising from modification. We strongly recommend that this product not be modified and/or used for any application other than that for which it was designed. If you have any questions relative to a particular application, DO NOT use the product until you have first contacted us to determine if it can, or should, be performed on the product.

For technical questions, please call **1-218-943-6296**.

TECHNICAL SPECIFICATIONS

Coverage	60" working width
Single Tine Qty.	22
Tine Section Qty.	2

IMPORTANT SAFETY INFORMATION

 **WARNING:** Read and understand all instructions. Failure to follow all instructions listed below may result in serious injury.

 **CAUTION:** Do not allow persons to operate or assemble this Pine Straw Rake until they have read this manual and have developed a thorough understanding of how it works.

 **WARNING:** The warnings, cautions, and instructions discussed in this instruction manual cannot cover all possible conditions or situations that could occur. It must be understood by the operator that common sense and caution are factors that cannot be built into this product, but must be supplied by the operator.

SAVE THESE INSTRUCTIONS

WORK AREA

- **Keep work area clean**, free of clutter, and well-lit. Cluttered and dark work areas can cause accidents.
- **Keep children and bystanders** away while operating the Pine Straw Rake. Distractions can cause you to lose control, so visitors should remain at a safe distance from the work area.
- **Be alert of your surroundings.** Using a Pine Straw Rake in confined work areas may put you dangerously close to sharp tools and rotating parts.

PERSONAL SAFETY

- **Stay alert**, watch what you are doing, and use common sense when using a Pine Straw Rake. Do not use while you are tired or under the influence of drugs, alcohol, or medication. A moment of inattention while operating a Pine Straw Rake may result in serious personal injury.
- **Dress properly.** Do not wear loose clothing, dangling objects, or jewelry. Keep your hair, clothing, and gloves away from moving parts. Loose clothes, jewelry, or long hair can be caught in moving parts.
- **Use safety apparel and equipment.** Use safety goggles or safety glasses with side shields that comply with current national standards or, when needed, a face shield. Use a dust mask if working in dusty work conditions. This applies to all persons in the work area. Also use non-skid, safety shoes, hard hat, gloves, dust collections systems, and hearing protecting when appropriate.
- **Do not have passengers** on the tractor when using the Pine Straw Rake.

PINE STRAW RAKE USE AND CARE

- **Do not modify the Pine Straw Rake in any way.** Unauthorized modification may impair the function and/or safety and could affect the life of the equipment. There are specific applications for which the Pine Straw Rake was designed.
- **Always check for damaged or worn-out parts before using the Pine Straw Rake.** Broken parts will affect Pine Straw Rake operation. Replace or repair damaged or worn parts immediately.
- **Store idle Pine Straw Rake.** When the Pine Straw Rake is not in use, store it in a secure place out of the reach of children. Inspect it for good working condition prior to storage and before re-use.
- **Exercise extreme caution when changing direction on slopes.** Do not operate across slopes. Use up and down only. Do not attempt to operate on steep slopes.
- **Beware of hidden, underground objects.** Contact with hidden objects might cause a sudden stop of the towing vehicle and damage to the Pine Straw Rake.
- **Do not operate the vehicle at speeds higher than 10 mph** and use care when backing up.

ASSEMBLY

Step #1:

Assemble the Suspension Section (#3), the Right Angle Steel Section (#2), and the Left Angle Steel Section (#1) using 4 Hex Bolts (#10) and 2 Hex Lock Nuts (#9).

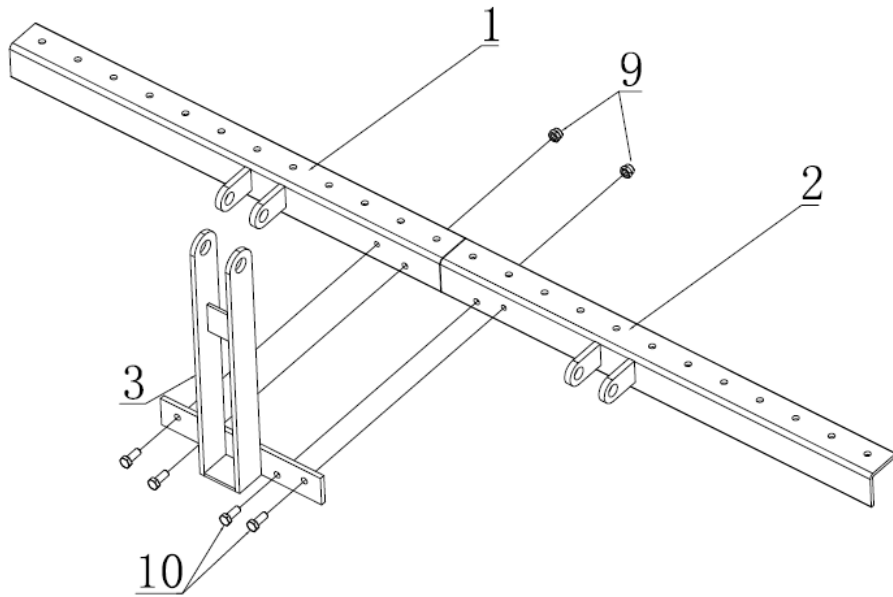

Step #2:

Assemble the 22 Single Tines (#6) and the 2 Tine Sections (#7) to the Right Angle Steel Section (#2) and the Left Angle Steel Section (#1) using 24 Hex Bolts (#8), 2 pressure plates (#5), thick pressure plate (#4), and 24 Hex Lock Nuts M10 (#9).

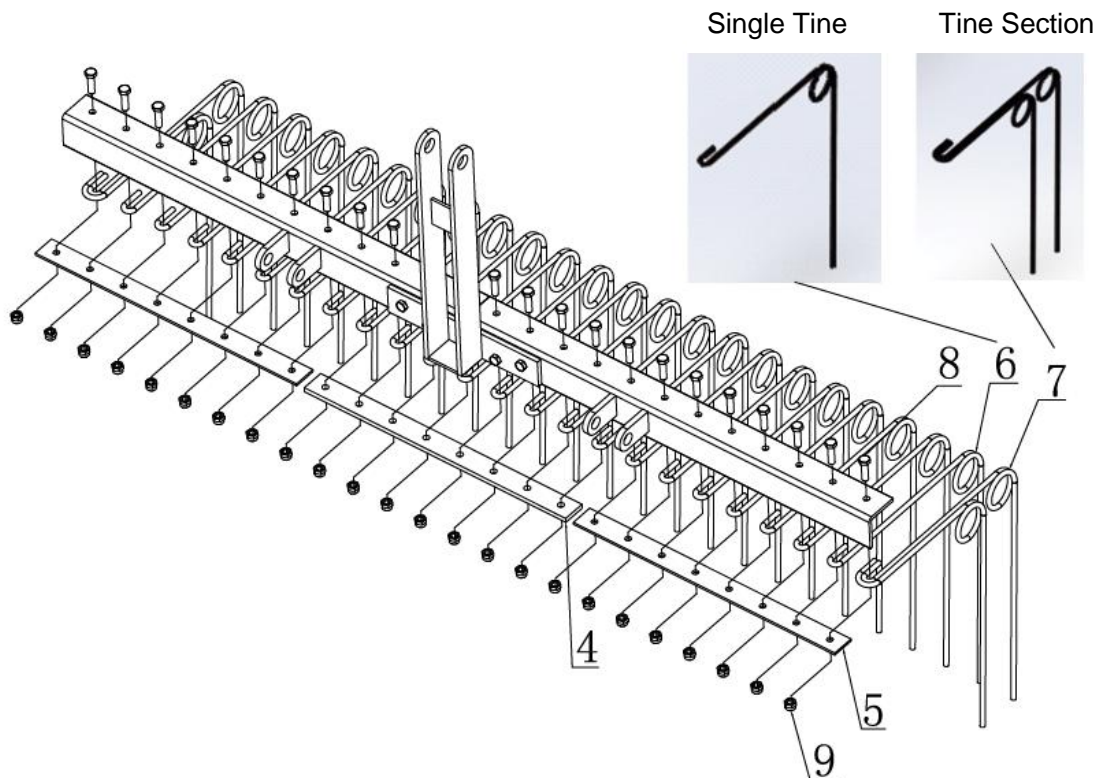

Step 3#:

Attach the Pine Straw Rake to your tractor.

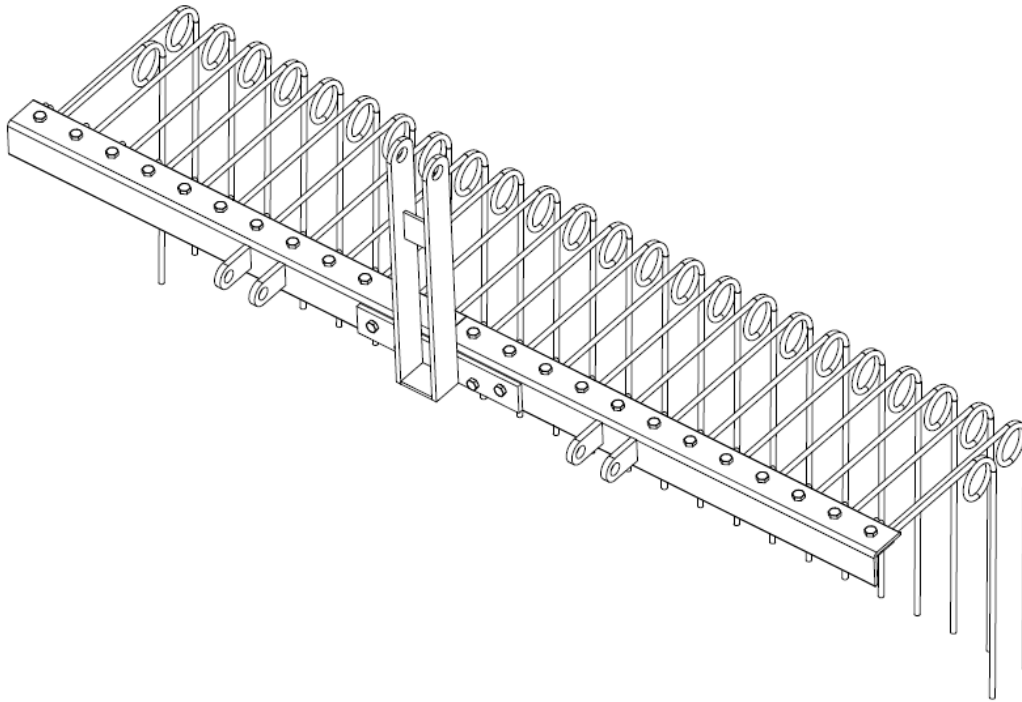

MAINTENANCE

- **Maintain your Pine Straw Rake.** It is recommended that the general condition of the Pine Straw Rake be examined before it is used. Keep your Pine Straw Rake in good repair by adopting a program of conscientious repair and maintenance. If any abnormal vibrations or noise occurs, have the problem corrected before further use. Have necessary repairs made by qualified service personnel.

PARTS DIAGRAM

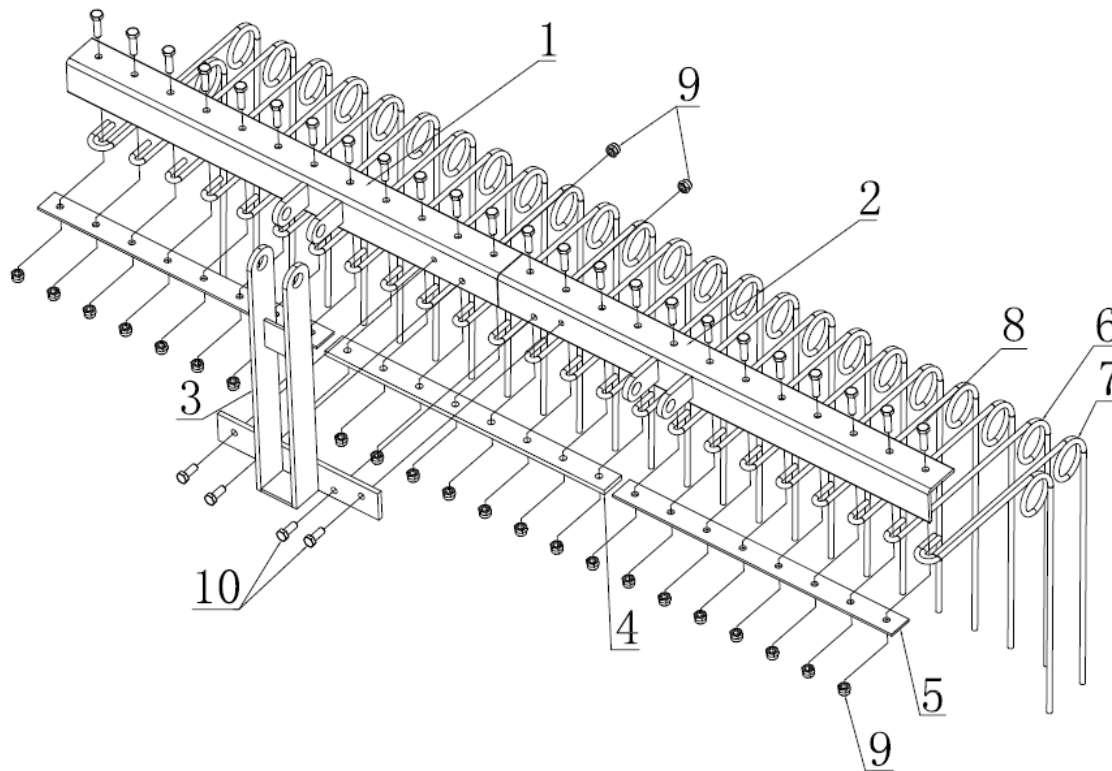

PARTS LIST

Part#	Description	Qty
1	Left Angle Steel Section	1
2	Right Angle Steel Section	1
3	Suspension Section	1
4	Thick Pressure Plate	1
5	Pressure Plate	2
6	Single Tine	22
7	Tine Section	2
8	Hex Bolt M10*35	24
9	Hex Lock Nut M10	26
10	Hex Bolt M10*25	4

For technical questions, please call **1-218-943-6296**.

WARRANTY

One-year limited parts warranty.



TG

PO BOX 203

Miltona, MN 56354

Made in China