



# User Guide

**Original Operating Instructions**

Robotic Mower  
RX20 Pro, RX20u, RX12u

 EN

*See  
how to  
Install*



 **Robomow®**  
*friendly home*



*I'm  
Robomow,  
nice to  
meet you.*



**Your safety is important to us -**

Please review this Manual carefully for all safety warnings and take extra caution to keep both children and pets off the lawn when Robomow is in operation.

**Safety first.....** 

**Installation.....** 

**Quick reference.....** 

# ***Safety first***

IMPORTANT!

READ CAREFULLY BEFORE USE

KEEP FOR FUTURE REFERENCE

- 1** ***Warning decal definitions***
- 2** ***Safety warnings & precautions***
- 3** ***Robomow safety features***



Do not allow children to use or operate Robomow.  
Children must be supervised at all times.

# 1

# Warning decal definitions

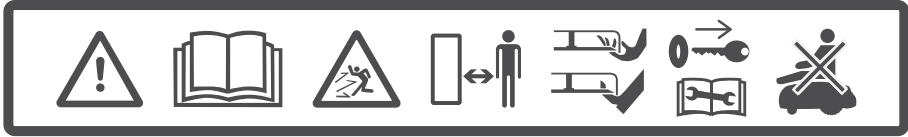

1

2

3

4

5

6

7

1. This is a dangerous power tool. Exercise care when operating and follow all safety instructions and warnings.
2. Read the Safety Manual carefully before operating your Robomow.
3. Be careful of thrown objects during operation.
4. Keep a safe distance from Robomow while it is operating. Keep people, especially children, pets and bystanders away from the area where Robomow is operating.
5. CAUTION – Do not touch rotating blade. Keep hands and feet away and do not lift Robomow from the ground.
6. Remove the disabling device before working on or lifting Robomow (see Section 3.b).
7. Do not ride Robomow.



Do not dispose of Robomow or any of its parts as unsorted municipal waste. It should be collected separately.



This product conforms to applicable EU directives.



This symbol is normally found on plastic enclosures and indicates that the mains electricity is double insulated



This symbol indicates that the product is designed for indoor use only.

# 2

## **Safety warnings & precautions**

---

### **A. Before you begin**

1. Read this Safety Manual carefully before operating Robomow to become familiar with its controls and proper use.
2. Never allow children, persons with reduced physical, sensory or mental capabilities or lack of experience and knowledge or people unfamiliar with these instructions to use the machine. Local regulations may restrict the age of the operator.
3. You are responsible for accidents or for harm to other people or their property.
4. It is your responsibility to inform your neighbors about the risks, and that it is forbidden to enter your lawn while Robomow is operating.
5. If your lawn is open to the street and/or your neighbors, you must be present during the mower's operation to prevent others from accessing your lawn. Alternatively, you must protect / fence your lawn so that others will not be able to access the mower during operation.

### **B. Preparations**

1. Ensure the correct installation of the Perimeter Wire, as instructed.
2. Inspect periodically the area where Robomow is used and remove all stones, sticks, cones, wires and other foreign objects.
3. Periodically visually inspect to verify that the blade is not worn or damaged. Replace a worn or damaged blade (Part No. MRK9100A). Switch Robomow off when inspecting or replacing the blade.

## C. Operation

### **IMPORTANT SAFETY WARNING!**

**Do not leave Robomow to operate unattended if you know that there are pets, children or people in the vicinity.**

**Never mow while people (especially children) or pets are nearby.**



1. Do not operate Robomow if any safety feature or any part is damaged, worn or inoperable.
2. Keep hands and feet away from the cutting blade and other moving parts.
3. Always switch Robomow off before lifting it or planning to operate any adjustments.
4. Never pick up or carry Robomow while the motors are running.
5. Do not touch the blade before it has completely stopped rotating.
6. Do not use Robomow for any purpose other than cutting lawn.
7. Keep all guards, shields, safety devices, and sensors in place. Repair or replace damaged parts, including decals.
8. Set the weekly program at times when there are no people on the grass.
9. Do not connect a damaged power cord to the supply, or touch a damaged cord before it is disconnected from the supply as it can lead to contact with live parts.
10. Keep the extension power cord away from the blade to prevent Robomow from damaging it. A damaged power cord can lead to contact with live parts.
11. If the power cord becomes damaged or entangled during use, detach it from the mains by pulling the plug from the socket.
12. In the event of accident or breakdown whilst Robomow is operating, immediately press the red STOP button.

## **D. Transportation**

Within the working area:

1. Press the STOP button to stop Robomow.
2. Switch Robomow off, and carry it by its carrying handle as shown in the picture to the right.

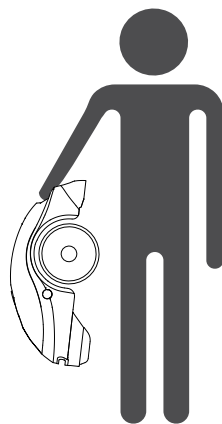

Over long distances:

When transporting Robomow over long distances, make sure it is switched off.



**IMPORTANT!** It is recommended to keep the original packaging for shipping purposes.

---



## **E. Using the remote control (manual mowing)**

1. Mow only in daylight or in good artificial light, and avoid operating on wet grass.
2. Do not operate Robomow barefoot or wearing open sandals. Always wear substantial footwear and long trousers; always make sure of your footing on slopes.
3. Use extreme caution when reversing the direction of the mower towards you.
4. Always switch on the motor according to the instructions while standing away from the blade.
5. Do not mow manually in slopes greater than 15 degrees or where a firm footing is not possible.

## **F. Batteries**

1. Do not open or damage the battery pack.
2. The Battery Pack contains electrolytes. In case of an electrolyte leakage from the Battery Pack, the following actions should be taken:
  - Skin contact: Wash the contact areas off immediately with water and soap.
  - Eye contact: Flush the eyes with plenty of clean water for at least 15 minutes immediately, without rubbing.
  - Get medical assistance.
3. Ensure that the battery is charged using the correct charger recommended by the manufacturer. Incorrect use may result in electric shock, overheating or leakage of corrosive liquid from the battery.

## **G. Maintenance and special instructions**

1. Always switch Robomow off and remove the Disabling Device before clearing blockage/checking/cleaning/working on it, or after striking a foreign object to inspect the machine for damage. Never attempt to service or adjust the mower while it is in operation.
2. In case of abnormal vibrations, stop the mower, switch it off and check for any damage of the blade. Replace a worn or damaged blade (Part No. MRK9100A) to preserve balance. If the vibration continues, call for service.
3. Use heavy gloves when inspecting or servicing the blade.
4. Do not perform maintenance barefoot or wearing open sandals. Always wear suitable work shoes and long trousers.
5. Replace worn or damaged parts for your safety.
6. Use only original equipment and accessories. It is not permitted to modify the original design of Robomow. All modifications are made at your own risk.
7. Ensure that only replacement cutting means of the right type (Part No. MRK9100A) are used.
8. Maintenance/servicing/cleaning of Robomow should be according to manufacturer's instructions.
9. Keep all nuts, bolts and screws tight to be sure the machine is in safe working condition.



### **WARNING!**

When there is a risk of a lightning storm, disconnect the Perimeter Wire from the Base Station and the Power Supply 230 V/120 V plug from the power outlet.

## **H. Product end of use**

1. Robomow and its accessories should be collected separately at the end of their life to prevent waste electrical and electronic equipment from ending up in landfill sites, and to protect and improve the quality of the environment.
2. Do not dispose of Robomow or any other of its parts (including the Power Supply and Base Station) as unsorted municipal waste – they should be collected separately.
3. Ask your local distributor/dealer about return and collection systems availability.
4. Do not dispose of the battery pack in a fire, and do not place used batteries in your household trash.
5. The battery must be collected, recycled, or disposed of in an environmentally sound manner.

# 3

## Robomow safety features



### **WARNING!**

Robomow is equipped with numerous built-in safety features. However, the mower is a hazardous device with a sharp blade, which can cause major injury to anyone who comes in contact with it.

Therefore, it is absolutely forbidden to be on the lawn while the mower is working. Alternatively, halt the mower's operation when people (especially children) or pets are to stay or play on the lawn.

### **A. Child Lock**

The Child Lock prevents unintended operation of Robomow by an accidental press of one of the buttons. Only pressing two buttons in the right order will initiate the operation. It is required to activate the Child Lock feature if children under age 6 may come in contact with Robomow.

### **B. Disabling Device**

The Disabling Device will prevent anyone from operating Robomow when it is removed. It is highly recommended to remove the Disabling Device to prevent operation of the mower by children or people who are unfamiliar with Robomow or are not allowed to use it.

### **C. Lift Sensor**

If the mower is raised from the ground during the blade's operation, the blade will stop rotating immediately.

## **D. Tilt Sensor**

If the mower is tilted up towards a vertical position, the blade will stop immediately.

## **E. Obstruction Sensor**

Robomow detects interfering obstacles in its way during operation. When the mower collides with an obstacle, it will stop the rotation of the blade immediately, will stop movement in that direction and reverse itself away from the obstacle.

## **F. Emergency Stop Button**

Pressing the STOP button at any time during operation will stop the mower and the blade immediately.

## **G. GO/ON-OFF button**

The GO/ON-OFF button allows to completely power off your Robomow. Switching Robomow off will prevent it from any operation. It is required to switch Robomow off before lifting it and before any maintenance operation.

## **H. Base Station and Perimeter Wire**

Robomow cannot operate without a Perimeter Wire installed and activated through the Base Station. In the event the Perimeter Wire signal is turned off, Robomow will stop operating.

## **I. Anti-Theft (RX20u/RX20 Pro models only)**

The theft protection function will prevent anyone from using or driving Robomow unless they unlock it by connecting to it with a registered mobile device.

***Let's get  
started.  
Can't wait  
to mow your  
lawn***



# Installation

Congratulations on purchasing Robomow! You are just a few steps away from meeting your best team player. Very soon you will come to count on your Robomow to do a perfect job.

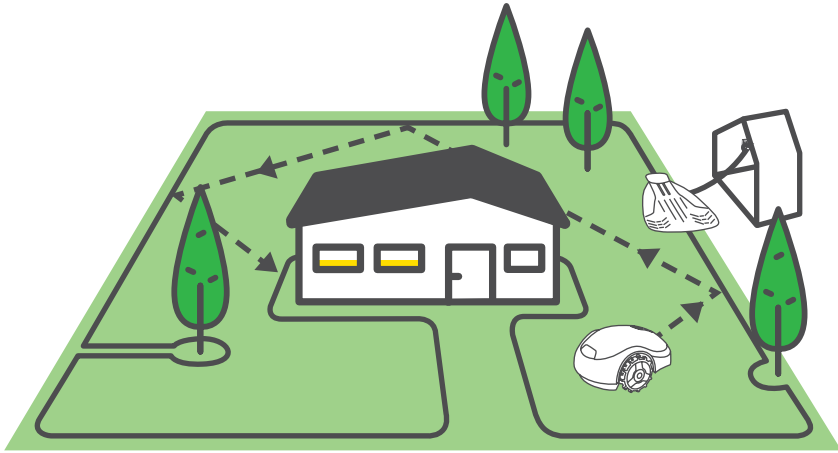

A preinstalled Perimeter Wire will set the boundaries (a “virtual wall”) for your Robomow. The Perimeter Wire will be laid around the edges of your lawn and objects that you want to protect.

Robomow will move randomly within its working area, as defined by the Perimeter Wire. This kind of random movement provides the perfect cut and ensures complete coverage of your lawn. At the end of each mowing ride, Robomow will automatically return to base for charging.

After a quick and simple installation, you will be ready to enjoy your free time while Robomow looks after your lawn.

# So where are we heading?

Correct installation of your Robomow will ensure maximum results. This is what it takes to prepare your Robomow to do a perfect job for you.

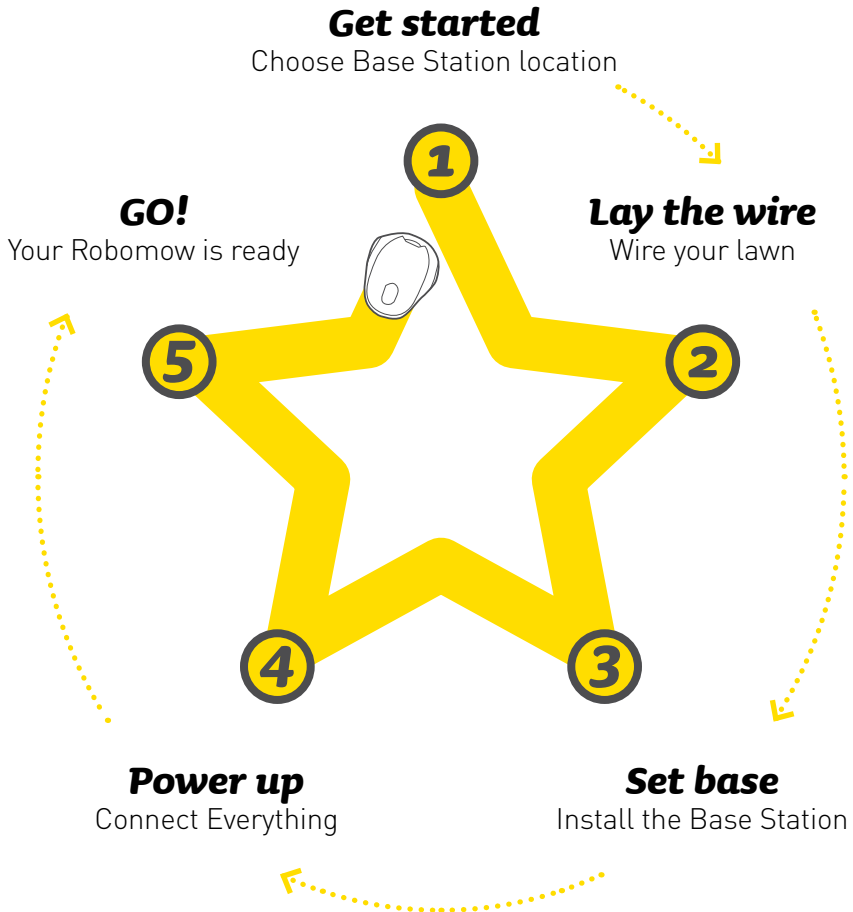



# This is what you find in the box

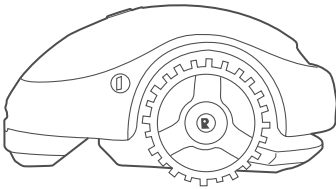

## Robomow RX model

Your new Robotic Mower

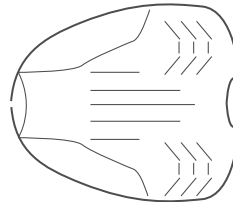

## Base Station

This is where Robomow recharges

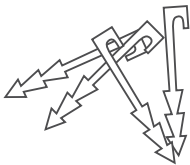

## Wire Pegs\* 150 pcs.

(100 pcs. for RX12u)

For securing the wire to the ground

*(\*) Not provided with RX20 Pro model*

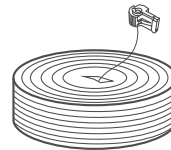

## Perimeter Wire with a plot connector\* 80 m / 260 ft

(70 m / 230 ft for RX12u)

Marks the working area for Robomow

*(\*) Not provided with RX20 Pro model*

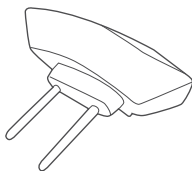

## Base Station Head

Generates Perimeter Wire signal

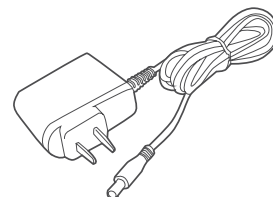

## Power Supply

With 10 m / 33 ft extension cable

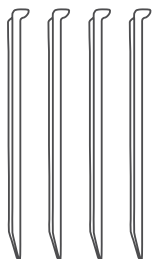

### Base Station Stakes (x4)

For fixing the Base Station to the ground



### Wire Connectors [X2]

For splicing the Perimeter Wire in case of a cut

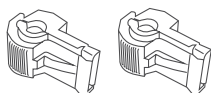

### Plot Connectors [X2]

For connecting the Perimeter Wire to the Base Station

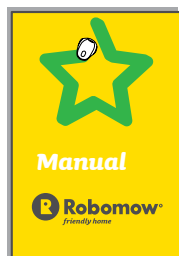

### Printed Instruction Material



### RoboRuler

For measuring the Perimeter Wire's distance from the lawn's edge

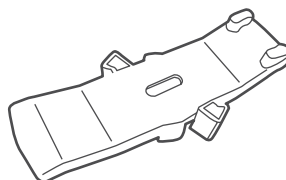

### RoboTool

For blades replacement and servicing. **IMPORTANT! Keep this tool for future use.**

# Ready? Let's begin...

# 1 Get started

## Choosing the Base Station location

The Base Station is where Robomow recharges, and where the Perimeter Wire starts and ends. In this installation step, you are going to determine a proper location for the Base Station.

### ***Prefer a corner installation***

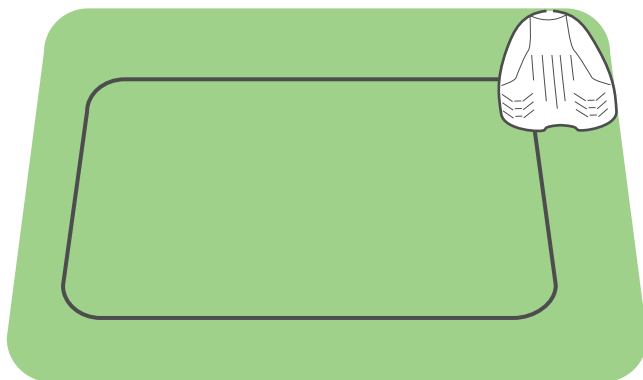

\*\* See additional installation options in Appendix A \*\*

**Follow these simple guidelines to find a proper location for your Base Station**

Up to 10 meters / 33 feet away from a power outlet

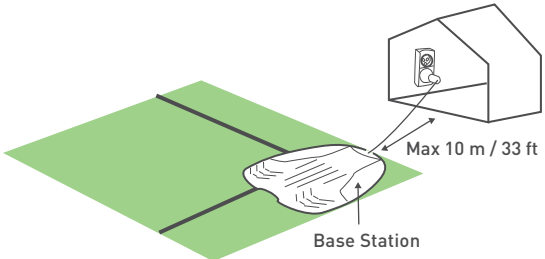

A min. of 1 meter / 3.3 feet straight wire before the base to allow smooth docking

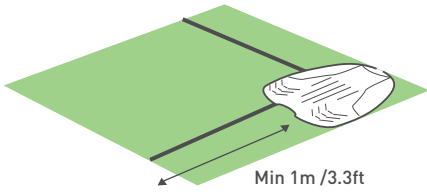

A minimum of 1 meter / 3.3 feet from a sprinkler head to avoid damaging the mower's internal components

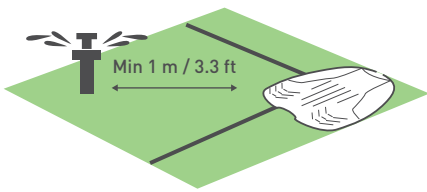

Even and flat (up to +/-5% slope)



The Base Station will be installed at a later stage, after the Perimeter Wire is in place.



**TIP**

## 2 Lay the wire

Lay the Perimeter Wire (“virtual boundary”), which defines the working area for Robomow



### TIPS

- Have your Robomow box nearby.
- Be sure to cut your grass with your old mower one last time before you start wiring. This will make inserting pegs easier and help ensure Robomow doesn't cut the wire.



### WHAT YOU'LL NEED



Hammer



Combination pliers



Cutter

### A. Make a good start

Use the RoboRuler to determine a distance, which you should keep between the Perimeter Wire and the lawn's edge.



- ① Measure RoboRuler distance **III** from the corner, where you intend to install the Base Station and mark this point on the ground.

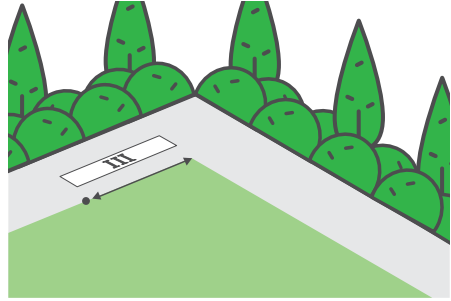

- ② Pull out the wire marked A from the Perimeter Wire spool; leave a tail of approx. 20 cm / 8"; once a tail is made, put the first peg into the ground to secure this wire end.

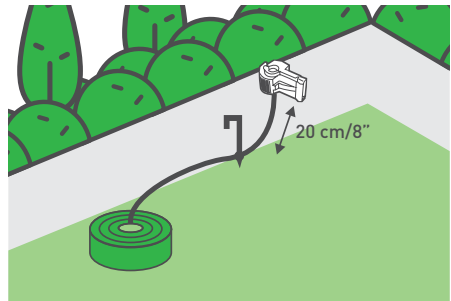

- ③ Drive pegs at two additional locations: at RoboRuler distance **I** along the edge from the first peg, and at RoboRuler distance **III** from the edge as shown in the picture.

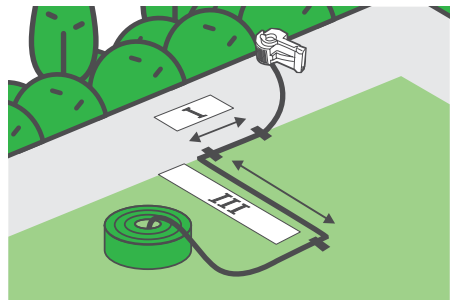



TIP

If your lawn has a corner with a relatively flat edge, you can move the beginning of the wire up to 60 cm / 2 ft outside the lawn.

**This will define how far off the lawn the Base Station will be installed.**

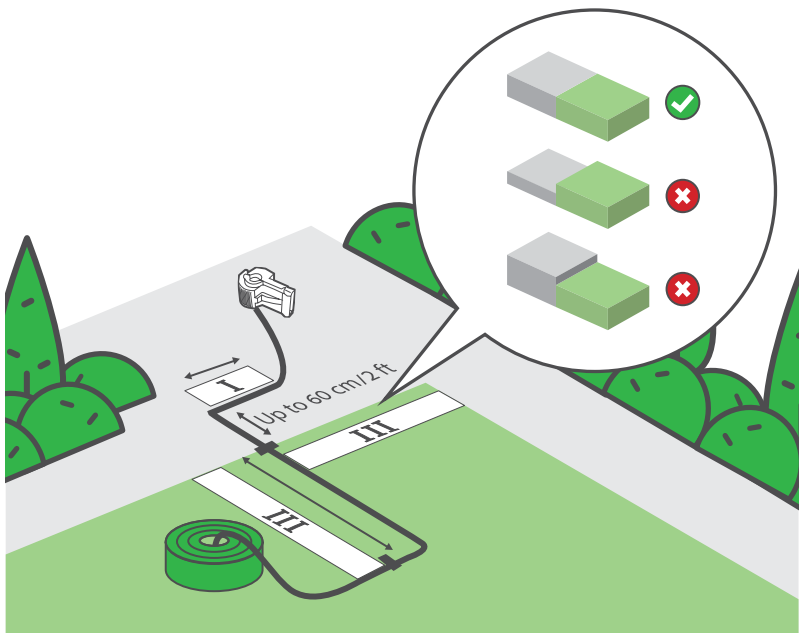

**Well done! This was the most complex part of the wire installation. Let's move on...**

## B. Keep proper distances



**Start unwinding the wire counter-clockwise around the lawn starting at the Base Station's location.**

Lay the Perimeter Wire loosely along the perimeter as you walk along the lawn's edge.



Use the RoboRuler to determine the distance, which you should keep between the Perimeter Wire and lawn's edge.

If the edge is relatively flat, lay the wire at RoboRuler distance **II** from it.

When the edge is a wall, use also distance **III** of the RoboRuler.

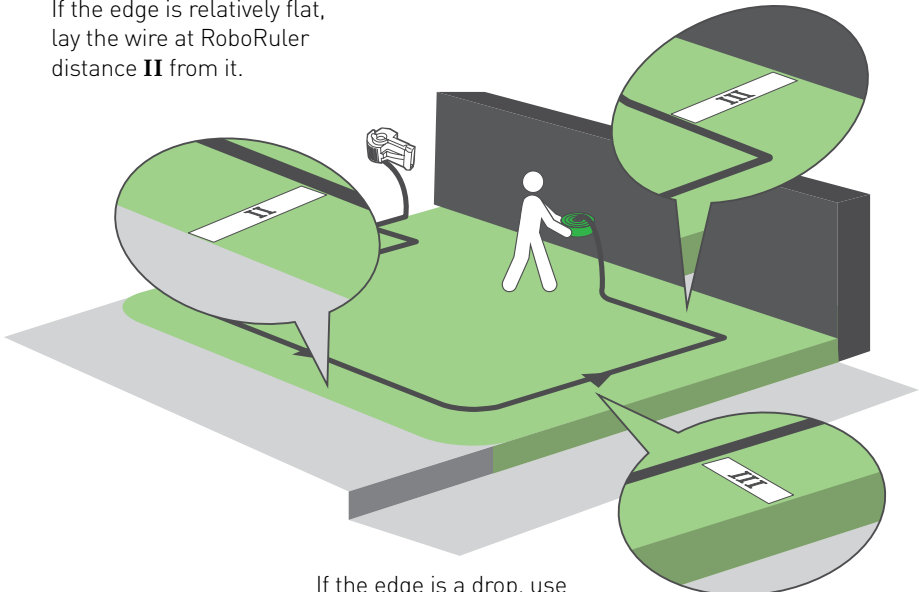

If the edge is a drop, use distance **III** of the RoboRuler.



Leave a minimum of 1.2 m (4 ft) if the edge of the lawn borders water.

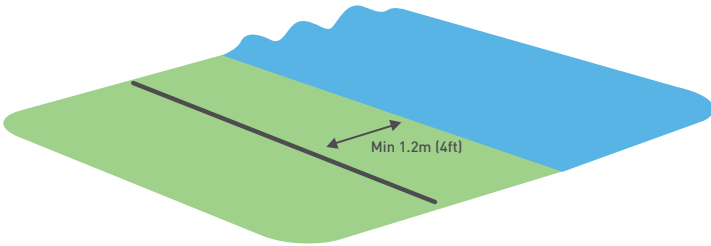

- The Perimeter Wire is secured to the ground by the pegs supplied with Robomow.
- Pull the wire tight while hammering the pegs to their final depth in the ground.
- Take care not to damage irrigation pipes.

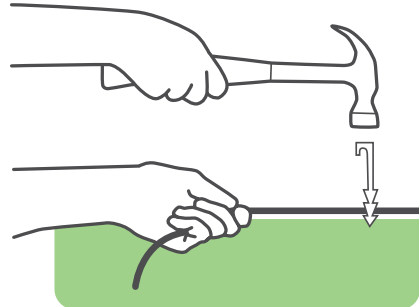

- Place the pegs every few tens of centimeters.
- Add pegs where necessary to keep the wire tight to the ground to avoid damaging it by Robomow.

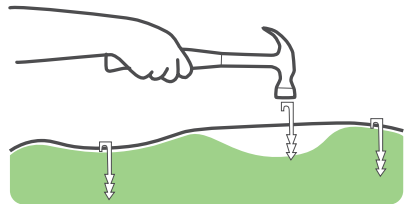

## C. Protect obstacles

### Hard obstacles

Obstacles that are vertical, rigid and higher than 15 cm (6 in), such as trees or telephone poles, do not need to be protected by the Perimeter Wire. Robomow will bump into them and turn away.

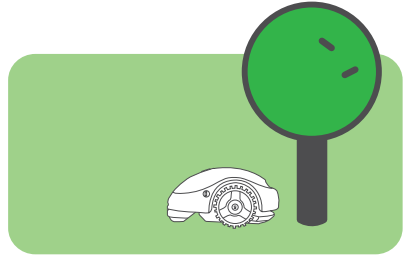

### Soft obstacles

Objects such as flower beds, ponds, or small trees must be protected by setting Perimeter Islands.

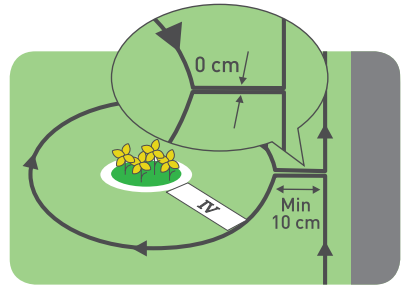

Set the Perimeter Wire **CLOCKWISE** around the obstacle, otherwise Robomow will drive into the Perimeter Island or won't be able to mow the area around it properly.



## D. What if you have secondary areas?

If your lawn has additional areas as shown below, see Appendix B.



OR

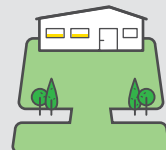

## E. Complete wire setup

- Arrive back to the base location until the two wire ends meet each other
- Make sure to keep at least 1.5 meters / 5 feet of a straight wire at the very end

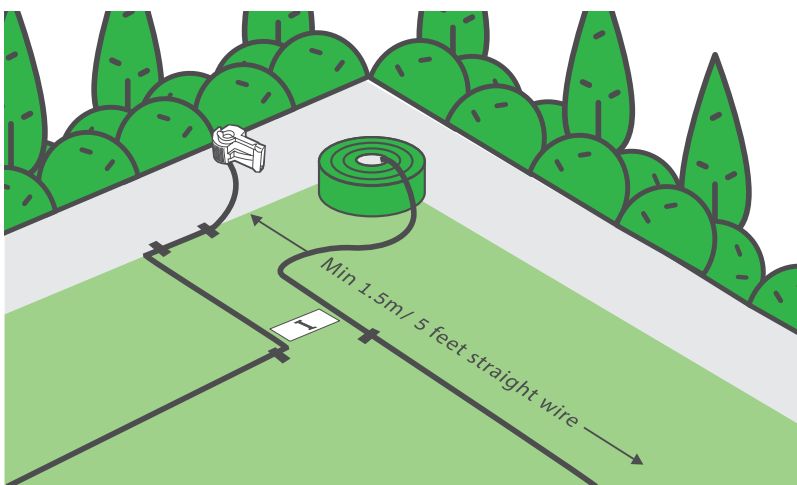

- Put the last peg very close to the first one

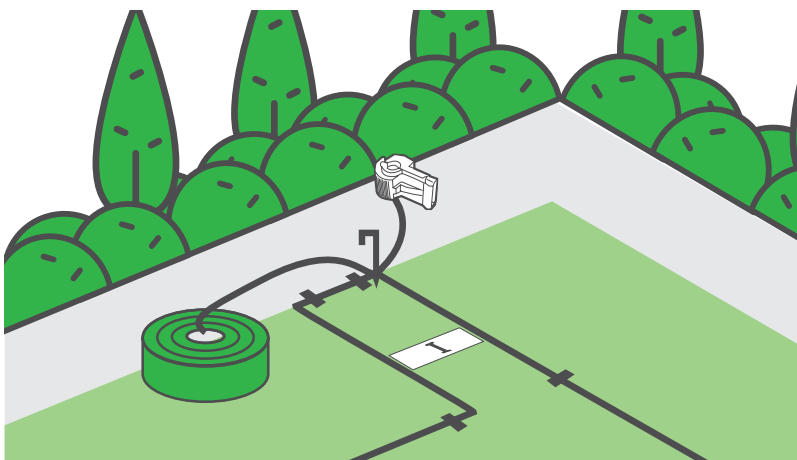

- Put one of the provided plot connectors on the second wire end
- Use pliers to press the connector and a cutter to cut off the remaining wire
- Make both wire end the same length

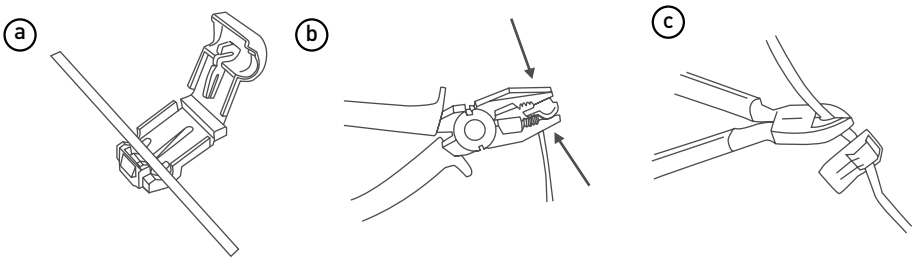

- Do not leave or create wire wraps

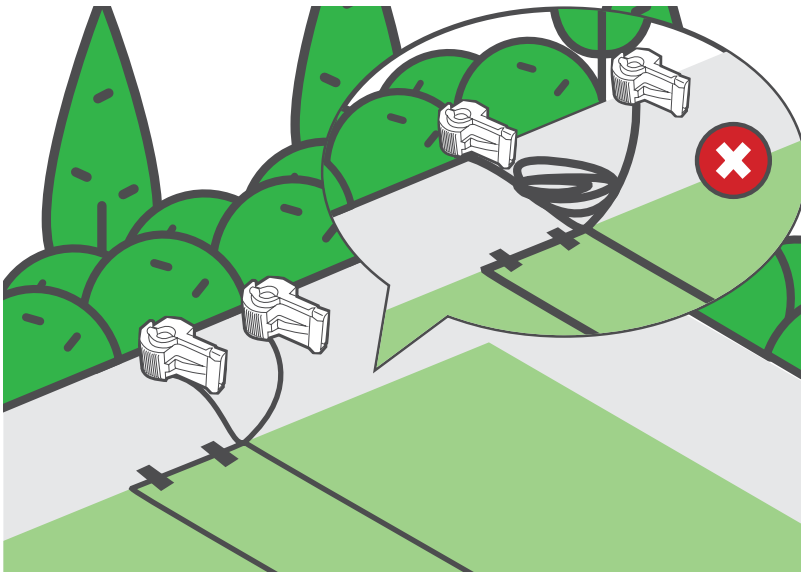

# 3 Set base

- Place the Base Station in its planned location
- Align it to the lawn's edge
- Use RoboRuler distance **I** to confirm that the center of the Base Station is properly shifted right relative to the wire, as shown in the picture

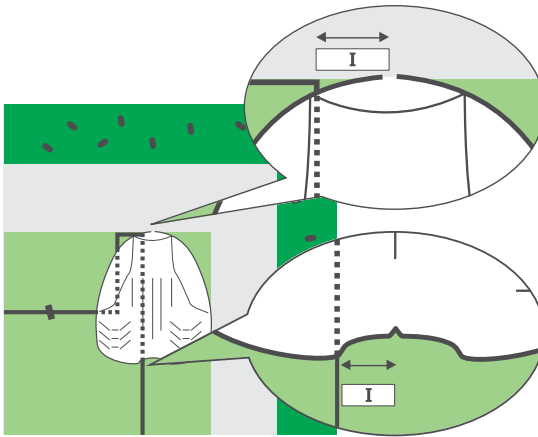

- Fix the base to the ground with the 4 supplied metal stakes

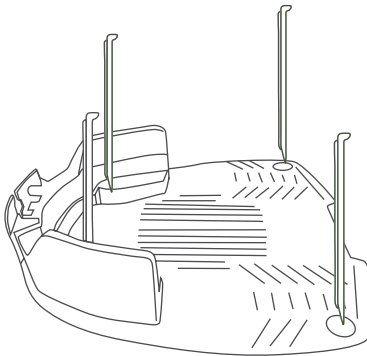

**Be careful not to damage irrigation pipes when hammering down the stakes.**

# 4 Power up

1. Connect the wire tail marked A to the A terminal and the other tail to the B terminal of the Base Station head.
2. Connect the power supply connector to the Base Station head as well.

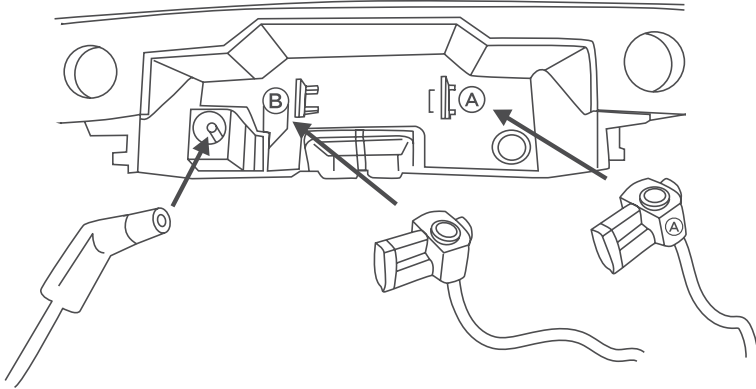

3. Note the markings for placing the Base Station Head.

Markings for placing the Base Station Head

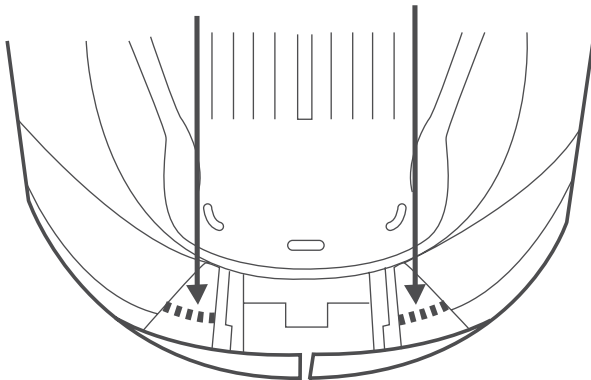

4. Place the head on the Base Station and align it with the markings as shown in the picture below.

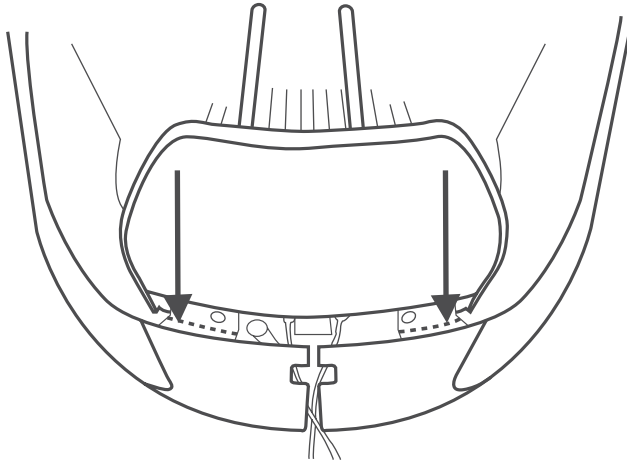

5. Slide the head all the way through.  
Pay attention to the sliders and a dedicated slot for threading the wires.

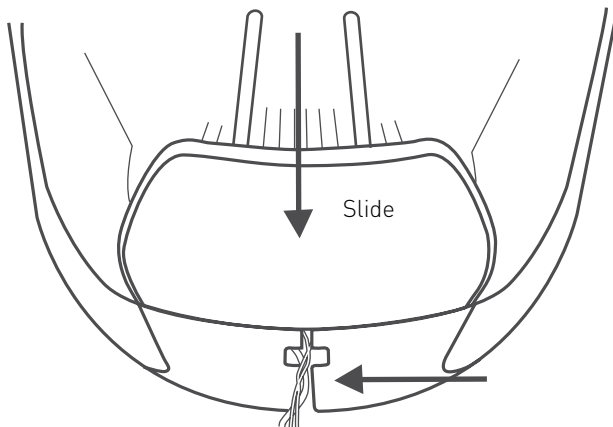



**TIP**

If for some reason you need to remove the base station head, you can do so by lifting the lever (A) and pushing it towards the inside of the base.

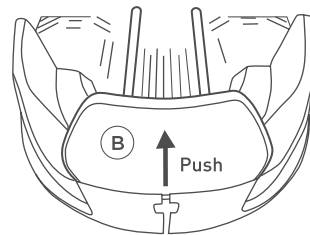
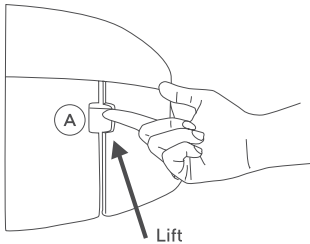

6. Plug in the power supply into a socket.

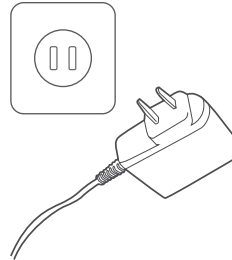

**Take the power cord out of the mowing area (to prevent Robomow from damaging it) and secure the cord firmly to the ground (so that it does not become a tripping hazard).**



# 5 GO!

- Place Robomow in the center of your lawn
- Press GO for 2 seconds to switch it on
- Now press the STOP / 🏠 once to send Robomow to the Base Station.

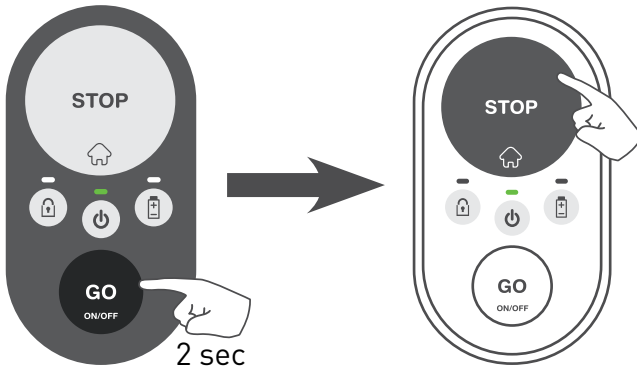

- Robomow will start driving\* towards the edge of the lawn to locate the Perimeter Wire. Once on it, Robomow will follow the wire to reach the Base Station and park there for charging.

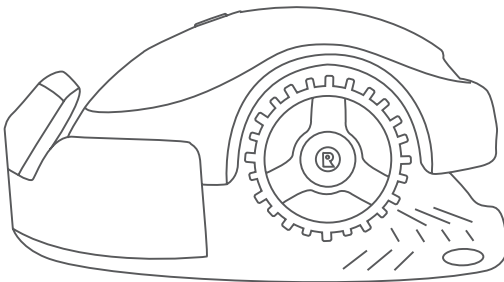

*[\*] If Robomow doesn't start driving, but plays a long beep and blinks with ON-OFF indication in red, you should swap the Perimeter Wire connection at the Base Station Head. For additional troubleshooting information please refer to "Troubleshooting" section in the "Quick reference" part.*

## Your Robomow is ready!

## Appendix A

### Additional installation options

1. On-wire with a **flat** edge.

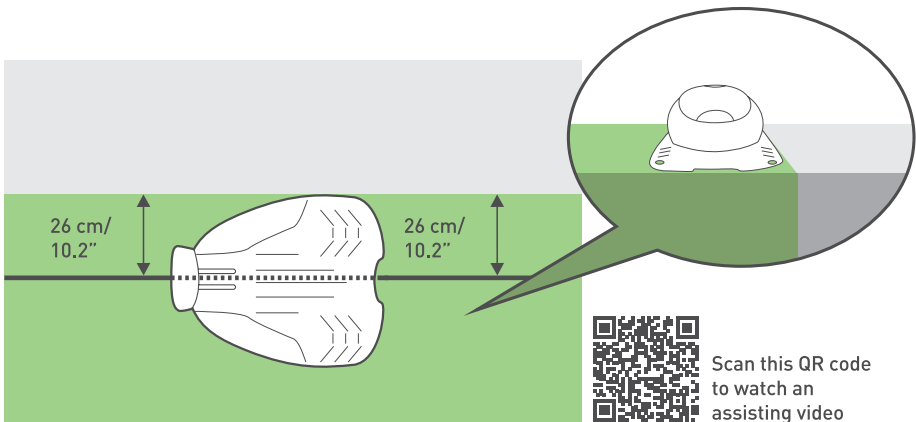

2. On-wire with a **drop** edge.

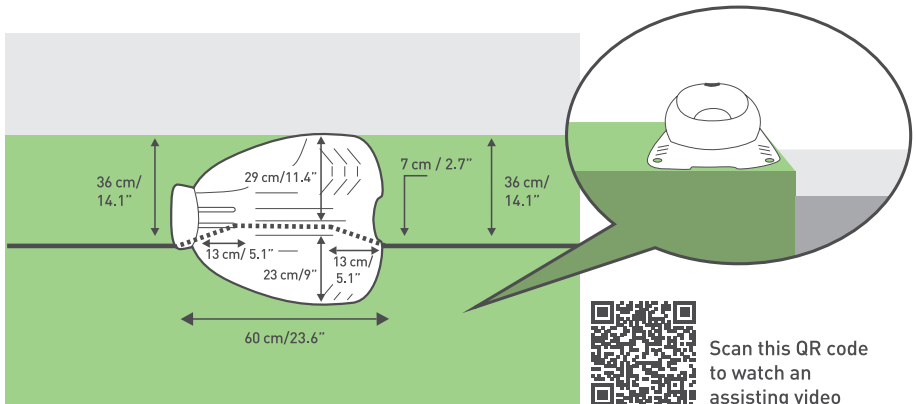

## Appendix B – Secondary areas

### Connected secondary areas

If your lawn has additional areas connected with a passage and Robomow is able to drive through it, then you should bear in mind the following rules:

- The minimal distance between the wires in such passage should be 15 cm / 6"
- The minimal width of such passage should be 57 cm / 22"

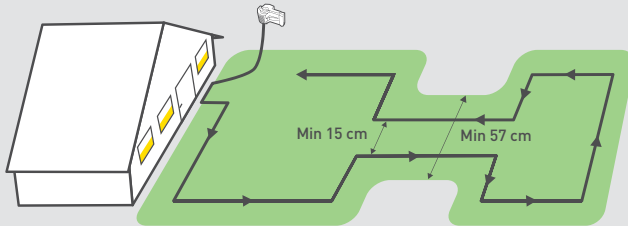

### Separated secondary areas

If your lawn has areas, that are completely separated (by a fence, sidewalk, pathway, etc.), then you can extend the perimeter wire to cover such secondary areas as shown in the picture below.

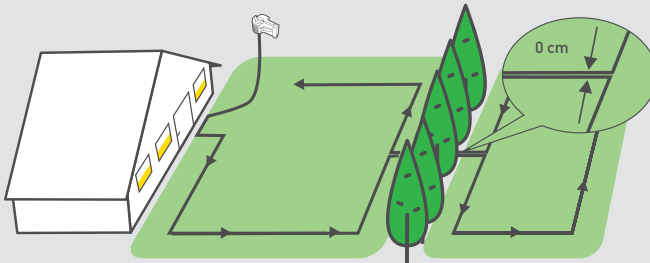

***Well Done!***

***Now relax, and let Robomow  
do the work.***

# ***Quick reference***

- 1** ***Knowing your Robomow***
- 2** ***Single-button operation***
- 3** ***Additional options with the mobile app***
- 4** ***Taking care of your Robomow***
- 5** ***Troubleshooting***
- 6** ***FAQs***
- 7** ***How to get service***
- 8** ***Specifications***
- 9** ***Warranty card***

# 1

# Knowing your Robomow

---

In order to fully enjoy your Robomow, learn about its different parts and messages. Understanding how Robomow works and interacts will lead to smooth and easy operation.

## Front side

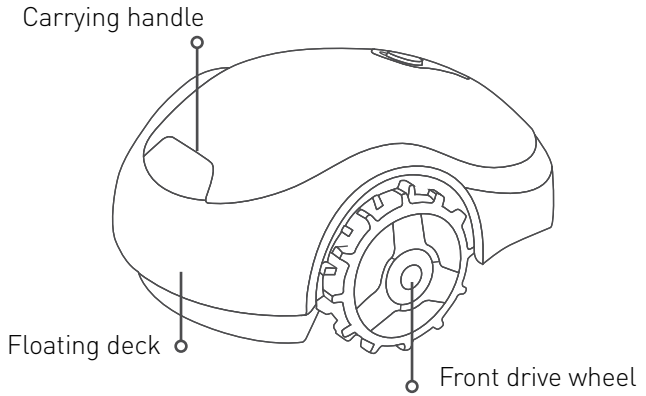

## Rear side

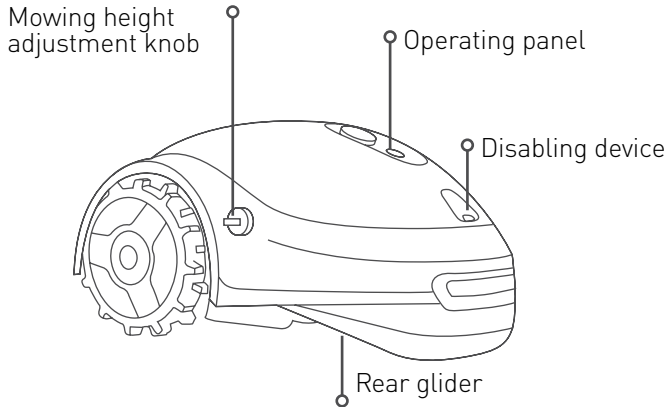

## Bottom view

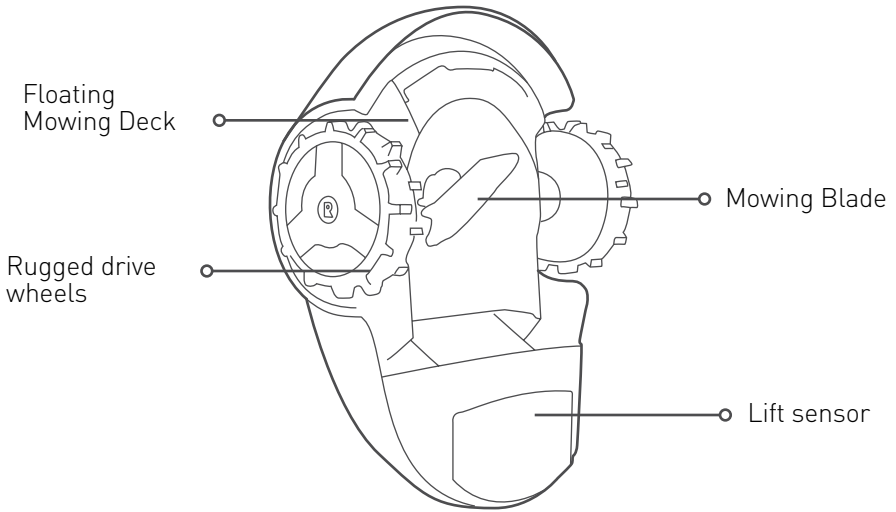

## Operating panel

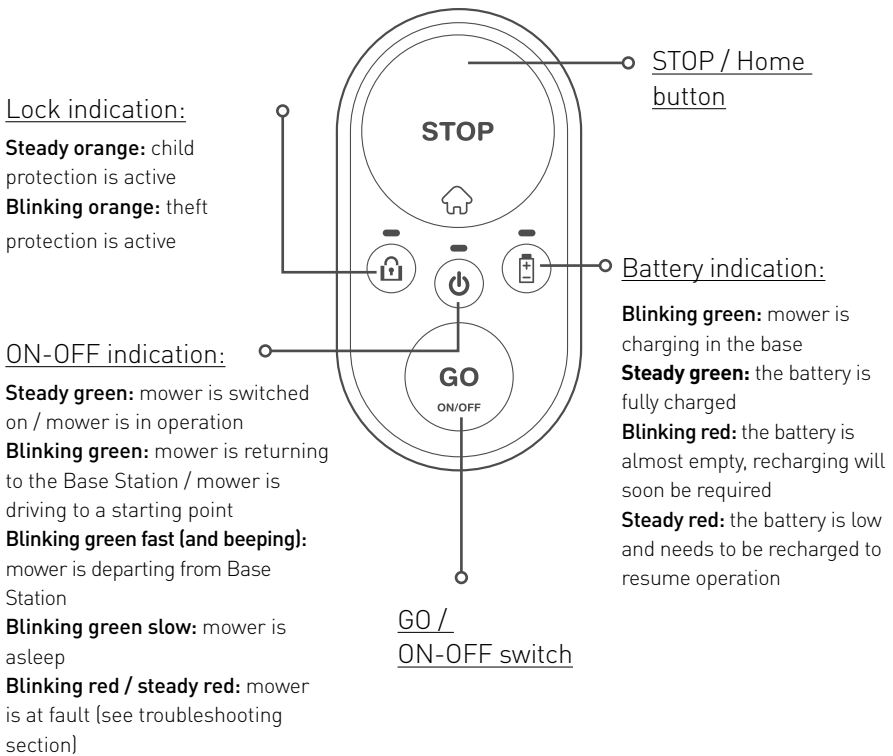



# Base Station

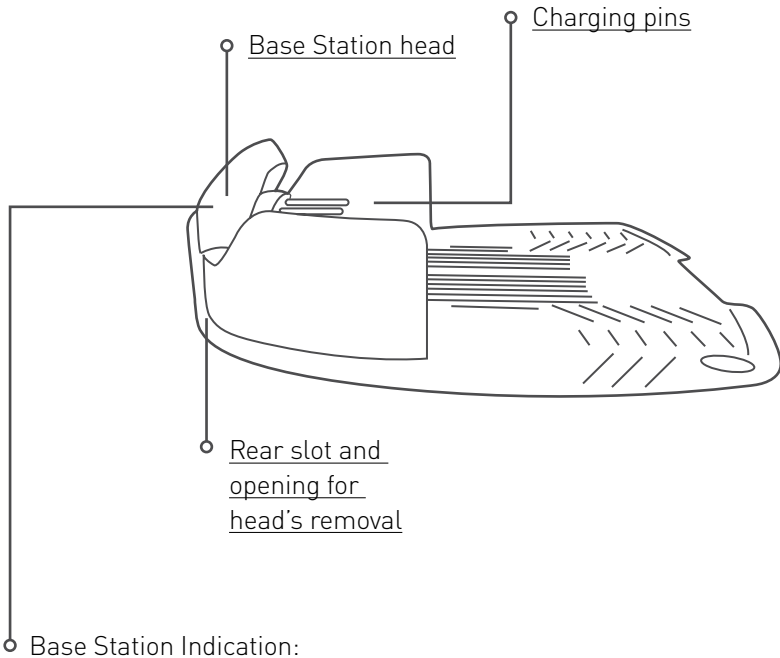

**Steady green:** perimeter wire signal is OK; the mower is inside the base

**Blinking green:** perimeter wire signal is OK; the mower is outside the base

**Blinking red fast:** perimeter wire is damaged or disconnected

**Blinking red slow:** poor perimeter wire connection or the wire is too long

**Steady red:** faulty power supply

## 2 Single-button operation

### Before anything else



#### IMPORTANT SAFETY WARNING!

Do not leave Robomow to operate unattended if you know that there are pets, children or people in the vicinity. Never mow while people (especially children) or pets are nearby.

- Clean the lawn from stones, fallen branches or other foreign objects before using Robomow.
- Set the mowing height to the desired level. We recommend setting the mowing height to the maximum during the first mowing operation or at the beginning of a season, and then gradually reducing it to the desired level.

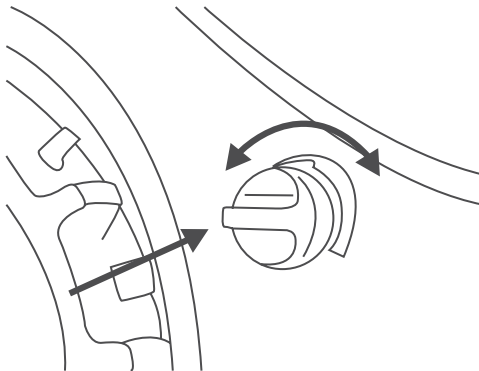

To set the mowing height, push and turn the mowing height adjustment knob to the desired direction:

- I means the lowest mowing height
- IIII means the highest mowing height

## Powering up Robomow

To power up Robomow, press and hold the GO button for 2 seconds until the ON/OFF indication is lit.

When you need to switch Robomow off, simply press and hold GO button for 2 seconds, until the ON/OFF indication goes off.

**Note:** If the theft protection is enabled (RX20 Pro/RX20u models), you will need to unlock your Robomow via the mobile app before you can switch it off.

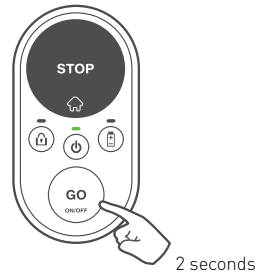

## Enabling child protection

Child protection prevents accidental use of Robomow by little children. When child protection is enabled, Robomow will require a special combination to start a mowing operation or to go back to its base.

To enable child protection, press and hold the GO + STOP buttons together for 6 seconds.

If you wish to disable child protection, press and hold the GO + STOP buttons together for 6 seconds again.

Alternatively, child protection can be enabled or disabled conveniently via the mobile app (RX20 Pro and RX20u models only).

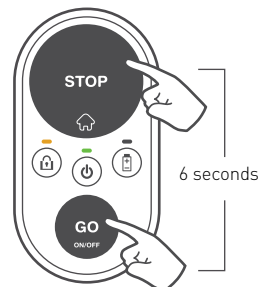

## Starting a mowing operation

Starting a mowing operation is super easy!

If you wish to start a **regular mowing operation** (up to 2 hours of continuous mowing), all you need to do is to press the GO button once.

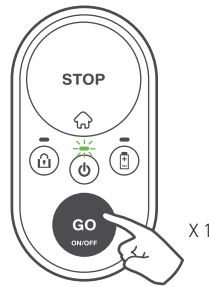

If the regular mowing duration is too long for your lawn, you can initiate a short mowing operation (of up to 60 minutes) by pressing the GO button twice.



When child protection is enabled, a special combination of keys is required to start a mowing operation. Hold down the STOP button and press the GO button once to unlock the child protection for 30 seconds. The Lock indication will be temporarily switched off. Now you can start a mowing operation as described above. As soon as the mowing operation is started, the child protection will automatically relock itself.

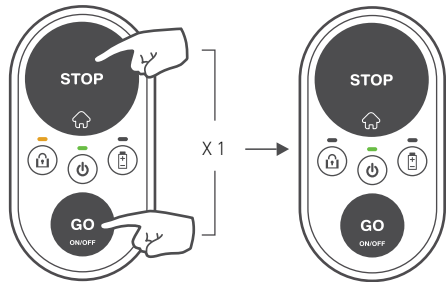

## Stopping an operation

To stop any current operation, press the STOP / ⏹ button.

## Sending Robomow to its base

To send Robomow to its base, simply press the STOP / ⏹ button when Robomow is inside the lawn.

If child protection is enabled, see the “Starting mowing operation” section above to temporarily unlock it. Then press STOP / ⏹ button to send Robomow to its base. The child protection will relock automatically.

## Automatic charging

Once a mowing operation is finished, Robomow automatically returns to its base station for charging to be ready for the next operation.

## How much mowing does your lawn need?

The amount of mowing depends on a season and on the size of your lawn. We recommend the following amounts of weekly mowing times per lawn size in peak season.

<b>Lawn size</b>	<b>Recommended weekly mowing times</b>
Up to 50 m <sup>2</sup>	2 hours
50 - 100 m <sup>2</sup>	4 hours
100 - 150 m <sup>2</sup>	6 hours
150 - 200 m <sup>2</sup> (RX20u / RX20 Pro only)	9 hours

## **3 Additional options with the mobile app**

---

### **(RX20 Pro/ RX20u models only)**

Robomow RX is a smart connected product. It comes with a built-in Bluetooth LE (Low Energy) device that enables you to control your mower from your smartphone.

A free complementary mobile app will allow you to experience your Robomow RX20u or RX20 Pro in a whole different way!

You can download the app (Android version only) by scanning this QR code.



Along with a totally exciting experience, it brings additional options and capabilities to your small and clever mower:

- Setting automatic mowing schedule
- Activating theft protection
- Defining additional starting points
- Remote controlling with manual mowing
- Remote diagnostics by a service station

## 4 Taking care of your Robomow

### Periodic maintenance



#### **WARNING** Severe injury hazard!

Always turn the Safety Switch off before lifting the mower. The blade is very sharp. It can cause severe cuts or lacerations. Always wear heavy work gloves when working with or around the blade. NEVER use a damaged or broken blade. Use only sharp blade.

#### Once a month:

- Inspect the underside of the mower. Clean if necessary. Carefully scrape the collected grass debris from under the mowing deck.
- Most grass accumulation can be removed using a small stick or similar object.
- Periodically inspect the Base Station, clean it from mud and debris to allow proper docking.

#### **IMPORTANT!**

**NEVER** use high pressure water to clean the mower. Liquids can damage components. Use only a damp or wet cloth to wipe the surface clean after scraping.



To allow better maintenance and to keep Robomow in good condition, it is recommended to take your Robomow to a certified Robomow dealer for service prior to winter storage.

## Operating the Disabling Device

- The Disabling Device prevents the operation of Robomow when it is removed.
- If the Disabling Device is pulled out, the current operation will be immediately halted, the Lock indication will blink three times and the ON/OFF LED will switch off.
- If any button on Robomow's operating panel is pressed, the Lock indication will blink three times to indicate that the Disabling Device is missing.
- If theft protection is enabled, it will remain active even though the Disabling Device is removed.

## Replacing the blade

1. Power Robomow off by pressing GO button for 2 seconds.

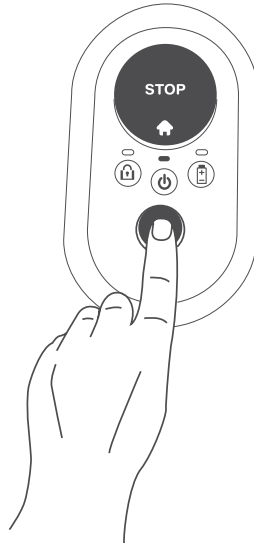



2.Remove the Disabling Device.

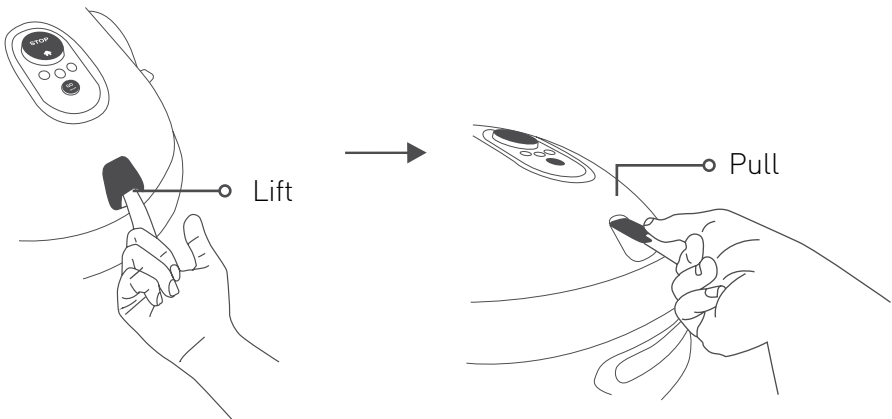

3. Put on heavy-duty gloves, and place RoboTool over the blade so that it covers the whole blade.

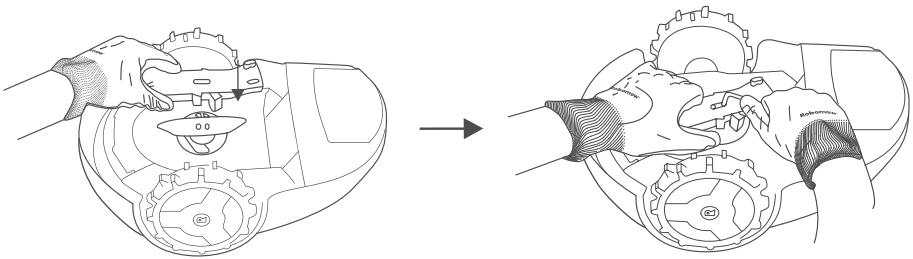

4.Use the provided Allen tool (comes with a replacing blade) to unscrew the screws while holding the blade with the RoboTool.

5. Replace the blade with a new one (Part No. MRK9100A).

6. Make sure to close both screws tightly.

## **Winter storage**

### **Robomow**

- Charge Robomow fully in its base
- Switch it off by pressing the GO button for 2 seconds
- Store in dry indoor conditions at ambient temperatures above 0°C.

### **Base Station**

- No winter storage is required for a Base Station. It can be left on the lawn during the winter period.
- It is recommended to disconnect the Power Supply from the mains during the winter storage period.

### **Winter service**

- To allow better maintenance and to keep Robomow in good condition, it is recommended to bring your Robomow to a certified Robomow dealer for service prior to winter storage.
- Winter service includes operations like cleaning the mower's parts and mowing deck, checking for worn parts (such as blade, drive wheels and other moving parts) and replacing them if required, testing the mower's functions and safety components, checking the battery, and uploading a latest software version, possibly including newly added features.

# 5 Troubleshooting

## Simple troubleshooting steps

In case of a fault, the Robomow On/Off indication will light up in red. Press any button to check for an optional sound indication for the fault. The table below will guide you to the corresponding action to take.

No. of beeps	ON-OFF indication	Meaning	Corrective action
•	Blinking red	Mower crossed outside / mower is stuck in place / lift event detected/ wrong wire connection	<ul style="list-style-type: none"> <li>• Check that the Perimeter Wire is not too close to the edge or not on a sloped area.</li> <li>• Move the mower inside the lawn or away from this particular location and renew the operation.</li> <li>• Check the ground ditches. Fill with dirt and level off.</li> <li>• Swap wire connections at the base station head</li> </ul>
••	Blinking red	Check the blade / mow motor overheat	<ul style="list-style-type: none"> <li>• Remove the Disabling Device and inspect the blade for foreign material or debris preventing rotation.</li> <li>• Increase cutting height.</li> </ul>
•••	Blinking red	No wire signal / waiting for signal / wire is cut	<ul style="list-style-type: none"> <li>• Confirm power supply is plugged into the power outlet.</li> <li>• Check power supply and perimeter wire connection to the Base Station.</li> <li>• Check the indication on the Base Station. If the wire is cut, repair is with the provided wire connectors.</li> </ul>
••••	Blinking red	Check drive wheels / drive motor overheat	<ul style="list-style-type: none"> <li>• Check the drive wheels and remove grass or other objects.</li> </ul>

<b>No. of beeps</b>	<b>ON-OFF indication</b>	<b>Meaning</b>	<b>Corrective action</b>
None	Blinking red (two LEDs)	No power supply / charging problem	<ul style="list-style-type: none"> <li>• Confirm power supply is plugged into the power outlet.</li> <li>• Confirm a good connection of the power supply to the Base Station.</li> <li>• Clean the charging pins.</li> </ul>
None	Steady red	Other faults	<ul style="list-style-type: none"> <li>• Check in the mobile app* or call Robomow service.</li> </ul>

\* Confirm a good connection between the power supply and the Base Station  
 (\*) All faults and corresponding corrective actions are communicated and described in the app as well. This feature is available for all RX models with production year 2017 (including RX12u).

## Special indications

<b>Indication</b>	<b>Meaning</b>
Periodic beeps + ON/OFF LED is red	Robomow has been lifted or tilted up.
Error sound + Battery LED blinks red two times	Mowing attempt while the battery is low. Need to recharge battery first.
Error sound + Lock LED blinks two times	Mowing attempt while child protection is enabled. Press the GO and STOP buttons together to temporary release the child protection. Now press GO once or twice to start mowing.
Error sound + Lock LED blinks three times	Mowing attempt while theft protection is enabled. Unlock the mower with a registered mobile device first.
ON/OFF LED & Battery LED blink together in red, when the GO button is pressed	Battery voltage is too low to switch the mower on. Need to keep charging.
Lock LED blinks three times while ON/OFF LED is off	The Disabling Device is removed. Insert the Disabling Device to operate the mower.

## Rebooting your Robomow

If for some reason your Robomow needs to be rebooted, simply switch it off and on.

## Resetting Robomow to factory defaults

When it is required to bring Robomow to its factory defaults, you may do so by pressing the GO button for more than 10 seconds (until you hear a long beep and all LEDs start blinking) while Robomow is switched off.

Have more  
questions?  
Get help here



## 6 Frequently Asked Questions

### ? **Mower does not dock properly and sometimes misses Base Station's contacts**

The entrance to the Base Station is not flat. Fill some ground to flatten the lawn around the Base Station to allow smooth entrance. Make sure the Perimeter Wire is laid according to the installation instructions on the supplied installation template. Make sure that the Base Station is placed on a relatively level ground.

### ? **Poor mowing quality**

The blade may be dull. Remove the Disabling Device. Put on heavy-duty gloves and inspect the blade. Replace if needed. Avoid mowing wet grass. For the best cut, operate Robomow when the grass is dry. It is recommended not to mow in the early morning hours.

### ? **Patchy and uneven mowing**

Current mowing times are not enough. Increase the time your Robomow runs on the lawn. Define additional starting points (RX20u / RX20 Pro models only) for a more uniform coverage.

### ? **Mower does not depart from base for a long time (RX20u / RX20 Pro models only)**

Tap and hold the grey Home button in the app for 3 seconds while the mower is in the Base Station. The non-depart reason will be displayed.



**Mower operates at wrong times (RX20 Pro / RX20u models)**

Verify that the time on the mower is set correctly. Time and Date settings need to be refreshed every time Robomow is switched on. The mower's time is automatically synchronized when it connects with a mobile device.



**Mower bumps in a rigid lawn's border too frequently**

Move the Perimeter Wire to be at a distance of 45 cm /18" from any rigid border (like a fence) at the lawn's edge.



**Robomow is very noisy**

The blade may be damaged or unbalanced. Check if the lawn is free from branches, stones or other objects that can damage the blade. Replace the blade if needed.

# 7 How to get service

---

The fault that you're experiencing with Robomow may be resolved doing some tasks on your own or consulting the Troubleshooting and FAQs in the User's Manual. If you do not succeed, you should contact the Robomow Contact Center.

## 1. Self-Service

Before contacting the Robomow Contact Center, try the following on your own:

- a. Verify that the Power Supply is connected to the mains and switched on correctly.
- b. Switch Robomow Off and On by pressing the GO button for 2 seconds.
- c. Consult the Troubleshooting and FAQs in the User's Manual to look for information about the problem.
- d. Visit the Robomow Help Center (Knowledgebase) at <https://support.robomow.com/hc/en-us>, where you can find additional answers to questions related to your product.

## 2. Robomow Contact Center

If you do not manage to solve the issue on your own, contact the Robomow Contact Center in your country (the email and phone number are available in the Robomow website). You should provide the Product's name, model number, serial number, a description of the problem, and a valid proof of purchase.

The following resolution options are available:

- a. Resolution by phone/email – a Robomow agent will attempt to resolve warranty issues, and may require your assistance in performing routine diagnostic procedures, adjustments/calibration or changing a setting.
- b. Resolution by shipping a replacement part - most parts are designed for simple replacement by the customer. If the Robomow agent finds that it is required to replace a part, they will ship it to you, including replacement instructions.
- c. Resolution by an authorized service provider - should the Robomow agent isolate malfunctions in your product that require additional diagnostics and repair by an authorized Robomow service provider, your Product will have to physically arrive to the service provider. It is up to you to take the Product to the service provider, ship it or ask for pickup service. In any case, you will have to pay all shipping costs, including insurance (where relevant). You are responsible for ensuring safe packing of the product. Scan the QR code to view a packing demonstration.





# 8 Specifications

	<b>RX20 Pro</b>	<b>RX20u</b>	<b>RX12u</b>
<b>Designation</b>	Robotic Mower	Robotic Mower	Robotic Mower
<b>Recommended Lawn Size</b>	200 m <sup>2</sup> (2150 ft <sup>2</sup> )	200 m <sup>2</sup> (2150 ft <sup>2</sup> )	150 m <sup>2</sup> (1600 ft <sup>2</sup> )
<b>Max Lawn Size</b>	300 m <sup>2</sup> (3200 ft <sup>2</sup> )	300 m <sup>2</sup> (3200 ft <sup>2</sup> )	250 m <sup>2</sup> (2700 ft <sup>2</sup> )
<b>Base Station</b>	Included	Included	Included
<b>Robot Dimensions</b>	53 x 42 x 26 cm (20.9" x 16.5" x 10.2")	53 x 42 x 26 cm (20.9" x 16.5" x 10.2")	53 x 42 x 26 cm (20.9" x 16.5" x 10.2")
<b>Package Dimensions</b>	66 x 54 x 30 cm (26" x 21.2" x 11.8")	66 x 54 x 30 cm (26" x 21.2" x 11.8")	66 x 54 x 30 cm (26" x 21.2" x 11.8")
<b>Robot Weight</b>	7.5 kg (16.5 lb.)	7.5 kg (16.5 lb.)	7.5 kg (16.5 lb.)
<b>Cutting Width</b>	18 cm (7")	18 cm (7")	18 cm (7")
<b>Cutting Height</b>	15-45 mm (0.6"-1.8")	15-45 mm (0.6"-1.8")	15-45 mm (0.6"-1.8")
<b>Mowing Power</b>	100 Watt	100 Watt	100 Watt
<b>Mowing Motors</b>	DC Brush	DC Brush	DC Brush
<b>Noise Level</b>	ECO Mode: 64 dB High Power: 67.9 dB Measured (Guaranteed – 69 dB) The noise at the operator's ears less than 70 dBA.		
<b>Maximum Altitude of Use</b>	3,000 m (9,800 ft)	3,000 m (9,800 ft)	3,000 m (9,800 ft)
<b>Battery Type</b>	Lead Acid	Lead Acid	Lead Acid
<b>Battery Capacity</b>	7 Ah	7 Ah	7 Ah
<b>Max Slope</b>	15% (8.5°)	15% (8.5°)	15% (8.5°)
<b>Remote Starting Points</b>	Up to 2	Up to 2	0
<b>Mowing Time</b>	90-120 min	90-120 min	90-120 min
<b>Charging Time</b>	16 – 20 hours	16-20 hours	16-20 hours
<b>Power Consumption</b>	4 kWh/month	4 kWh/month	2.5 kWh/month
<b>GSM Module</b>	Included	Available	Available
<b>Wire &amp; Pegs</b>	Available	Included	Included
<b>Anti-Theft</b>	Yes	Yes	No
<b>Robomow App</b>	Yes (Android only)	Yes (Android only)	No
<b>Remote Control App</b>	Yes	Yes	No

# 9

# Warranty card

## What does this warranty cover?

This limited warranty covers defects in materials and workmanship in this product, with the exceptions stated below, when used under normal residential purposes only\*.

\* Normal residential purposes are defined as the use of the product in the same lot as your primary home. Use in more than one location is considered commercial use, and this warranty would not apply.

## How long does the coverage last?

This warranty runs for a period of three years\*\* (on RX20 Pro models purchased in Europe), two years (on RX12u and RX20u models purchased in Europe), or one year (on any models purchased in the US) from the purchase date.

A one-year warranty is given for the batteries, beginning from the date of purchase.

A Product or part that is repaired or replaced under this Limited Warranty shall be covered for the remainder of the original warranty period applying to the Product or part, or for 6 months, the longer of the two. Product accessories are warranted for a period of 6 months from the date of purchase.

\*\*Third year warranty upon registration within 90 days from first operation, covering labor and parts only.

## What does this warranty not cover?

This Limited Warranty does not cover transportation costs of any kind. The owner bears all responsibility for bringing the Product to the nearest authorized Robomow service provider, or for the transportation costs to an authorized Robomow service provider.

The Company does not warrant that the operation of the product will be uninterrupted or error-free.

This Limited Warranty does not extend to:

1. Any Product that has been damaged or rendered defective:
  - a. As a result of use of the Product other than for its normal intended use;
  - b. Due to failure to use the Product in accordance with the User's Manual, or due to other misuse or negligence in the use of the Product;
  - c. Due to any damage caused by accident, abuse, theft;
  - d. As a result of use of a water hose or any type of liquid for pressure cleaning the underside of the Product;
  - e. As a result of damage caused to the blade due to stones or other objects found on the lawn during operation;
  - f. By the use of parts not manufactured or sold by Robomow;
  - g. By modification of the Product or one of its parts;
  - h. As a result of service by anyone other than a Robomow authorized service provider;

- i. By improper transportation or packing when returning the Product to a Robomow authorized service provider;
  - j. As a result of improper battery care and/or improper charging process (using a different Power Supply or charger), or due to failure to properly prepare the mower or battery prior to any period of non-use (before winter time).
  - k. By improper installation or any costs or damages associated with improper installation or use of the product.
2. Regular maintenance, winter service, blade sharpening, inspection, fair wear or tear of consumable parts.
  3. Cosmetic damages such as scratches and dents, faded or discolored covers and plastics.
  4. Commercial or professional use of the Product.
  5. Environmental damages and/or defects resulting from leaving the Product outside in winter and snowy weather, and from not following Robomow's instructions for winter storage.
  6. Defects due to force majeure, for example, lightning, water flooding, fire, incorrect voltage.
  7. Repairs necessary due to water damage other than exposure to rain or irrigation sprinklers.

This warranty grants you specific legal rights, and you may also have other rights that vary from state to state.



WWW.ROBOMOW.COM



DOC9043A-EN v 02

robomow.com  