

newair[®]

AWB-360DB

Wine & Beverage Cooler

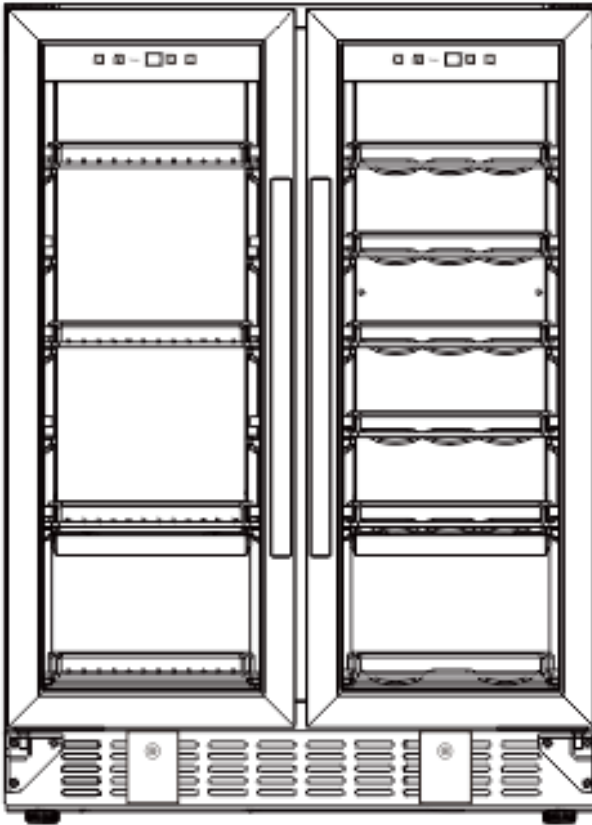

OWNERS MANUAL

Read and save these instruction.



A Name You Can Trust

Trust has to be earned and we will earn yours. Customer happiness is the focus of our business.

From the factory to the warehouse, from the sales floor to your home, the whole NewAir family promises to provide you with innovative products, exceptional service, and support when you need it the most.

Count on NewAir.

As a proud NewAir owner, welcome to our family. There are no robots here, real people shipped your product and real people are here to help you.

Thank you for your purchase and remember NewAir, A Name You Can Trust.

Call us today at 855-963-9247
Or email support@newair.com

For future reference, we recommend you attach a copy of your sales receipt here and record the following information. You will need this information if it becomes necessary to contact the manufacturer for service inquiries.

Date of Purchase: _____

Serial Number: _____

Model Number: _____



Connect with us online.

<http://www.NewAir.com>

READ AND SAVE THESE INSTRUCTIONS.

TABLE OF CONTENTS

Safety Information & Warnings	4
Parts List.....	5
Electrical Diagram	5
Assembly Instructions	6
Initial Setup	6
Installation Of Your Appliance	6
Positioning Your Wine and Beverage Cooler	7
Handle Installation	7
Operating Instructions	8
Setting The Temperature	9
Storing Wine	9
Door Lock	10
Shelves	10
Cleaning & Maintenance.....	11
Troubleshooting.....	11
Limited Manufacturer's Warranty	13

SPECIFICATIONS

MODEL NO.	AWB-360DB
VOLTAGE:	120 Volts
CURRENT:	2.0 Amps
FREQUENCY:	60Hz
POWER CONSUMPTION:	100 Watts
STORAGE CAPACITY:	18 Bottles & 60 Cans
TEMPERATURE RANGE:	36-72° F

SAFETY INFORMATION & WARNINGS

Before Using Your Wine And Beverage Cooler for the First Time:

Carefully read all instructions before using this wine and beverage cooler for the first time. Also make sure the wine and beverage cooler stays in an upright position during transportation. After removing the appliance from its packaging, make sure it is in good condition. If there are any issues with the wine and beverage cooler, please contact us immediately.

- Place the appliance on a level floor surface that will be strong enough to support it when it is at full capacity. To level the wine and beverage cooler adjust the leveling feet located at the bottom of the appliance.
- Do not use this wine and beverage cooler in applications for which it is not intended. Damage that occurs from improper use or from unauthorized repairs will void the warranty.
- For proper air circulation, please maintain a 2-inch minimum clearance in between the back of the wine and beverage cooler and the wall.
- Do not operate this wine and beverage cooler in excessively moist or humid environments.
- Keep the wine and beverage cooler away from direct sunlight.
- Keep the wine and beverage cooler away from hazardous materials or combustible/flammable substances.

★ CAUTION:

- This wine and beverage cooler is designed for built-in or freestanding applications.
- **DANGER: RISK OF CHILD ENTRAPMENT:** An empty wine and beverage cooler can be dangerous to children. Remove any latches, lids, locks, and/or doors from unused or discarded appliances to prevent child entrapment and suffocation. Never allow children to operate, play with or crawl inside this appliance.

PARTS LIST

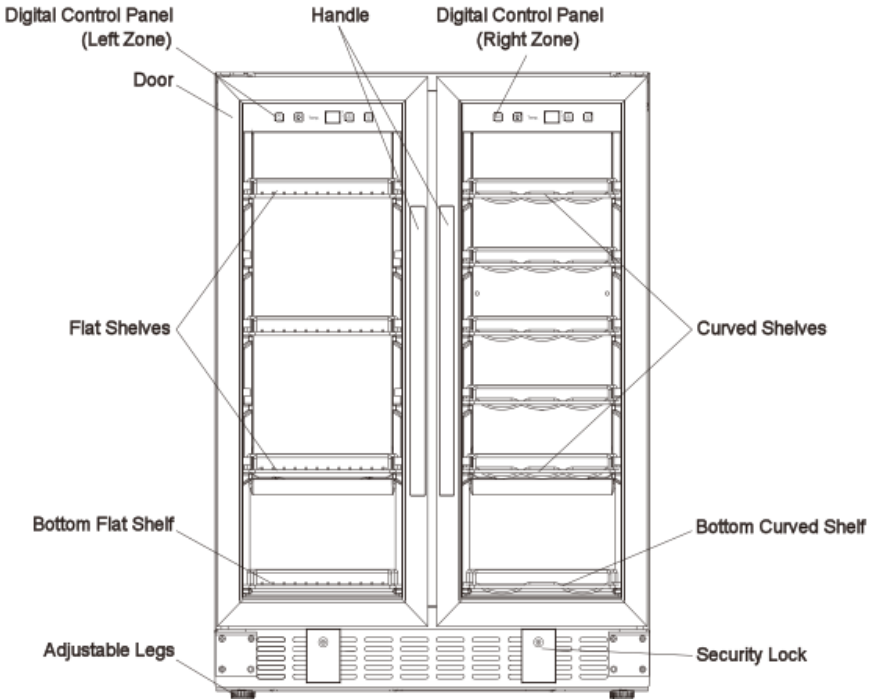

ELECTRICAL DIAGRAM

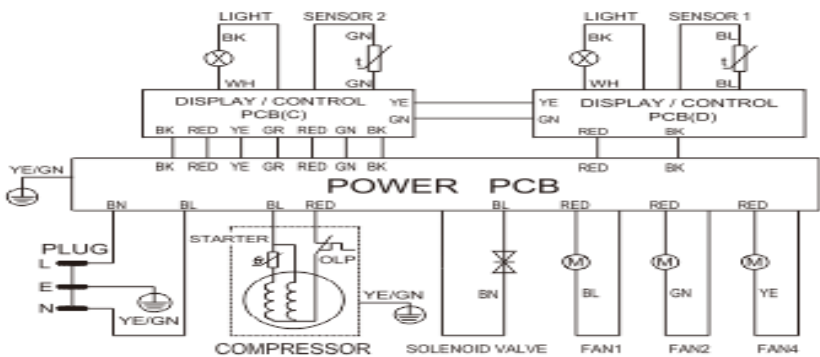

A Name You Can Count On

ASSEMBLY INSTRUCTIONS

INITIAL SETUP

Remove exterior and interior packing materials and connect the wine and beverage cooler to a power supply. Once it is plugged in, let it run for at least 30 minutes. Do not change the temperature or adjust any settings at this time.

INSTALLATION OF YOUR APPLIANCE

- Use two or more people to move and install the appliance. Failure to do so can result in back or other injury.
- Place your appliance on a floor that is strong enough to support it when it is fully loaded.
- Choose a well-ventilated area with temperatures above 60°F and below 90°F.
- This appliance is designed for built-in, recessed or free standing installation.
- For built-in installation, leave a 1/4" (6.35mm) space on each side and at the top of the appliance to ensure proper air circulation to cool the compressor and condenser.
- For freestanding installation, leave the proper clearance around the appliance. Below are the recommended clearances:
Side: 3/4" (19mm); Top: 4" (100mm); Back: 2" (50mm)
- Even for built-in installation, you must keep space on each side and at the top. If you plan to use the unit for a built-in application please follow the requirements shown below.

Cabinet Opening Dimensions (minimum)	
Width	24"
Depth	25"
Height	35"

- The appliance must be installed with all electrical, water and drain connections in accordance with state and local codes.
- Make certain that the pipes are not pinched, kinked or damaged during installation. Check for leaks after connection.

NOTE: Designed for indoor, home use only. The appliance should not be located next to sources of high heat or in direct sunlight. Do not store or install the appliance outdoors, in a garage, basement or in moist areas. Don't install in a location where the temperature will fall below 60°F. For best performance and to ensure proper ventilation, do not install the appliance behind a cabinet door or block the base grille.

POSITIONING YOUR WINE AND BEVERAGE COOLER

- It is important for the appliance to be leveled in order to work properly. You may need to make several adjustments to level it.
- To level your appliance, adjust the front legs at the bottom of the appliance.
- When positioning the appliance, ensure that there is at least a 1/4 inch clearance at the sides and a 1 inch clearance at the back of the cooler as this is the main outlet for heat. This will allow for adequate ventilation.

HANDLE INSTALLATION

- Pull away the door gasket in the area where the handle is to be installed. The gasket is easily removed by hand, no tools are necessary.
- Insert the two (2) Phillips head screws with the lock washers and flat washers through the gasket side of the door frame until the screws pass through the door frame. Follow the sequence shown in the figure.
- Align the handle with the screws installed in the above step. Tighten the screws using a Phillips head screwdriver until the handles secure tightly against the door frame. (Do NOT over tighten as this will cause damage to the handle assembly).
- Replace the door gasket to its original position.

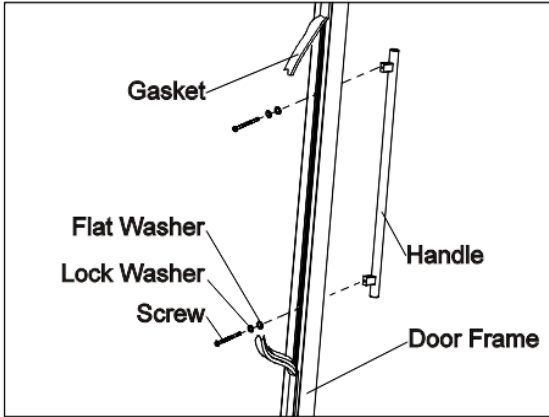

OPERATING INSTRUCTIONS



LEFT ZONE PANEL



RIGHT ZONE PANEL

Power 

Powers on/off the appliance. To turn off the appliance, touch the  mark and hold 5 seconds.

Light 

To control the interior light to turn on/off.

Up 

Used to increase the corresponding zone set temperature by 1°C or 1°F.



Down 

Used to decrease the corresponding zone set temperature by 1°C or 1°F.

°C/°F Selector

Selects the temperature display setting to display in Fahrenheit or Celsius.

SETTING THE TEMPERATURE

- The left zone temperature can be set between 36°and 72°F, and the right zone temperature can be set between 36°and 72°F.
- The temperature will increase by 1°C or 1°F if you touch UP  once, or the temperature will decrease by 1°C or 1°F you touch DOWN  once.
- To view the set temperature at any time, touch the UP or DOWN marks. The set temperature will temporarily flash in the LED display for 5 seconds.
- The internal storage temperature will appear in blue on the temperature display window.

NOTE: If the unit is unplugged, turned off, or power is lost, you must wait 3 to 5 minutes before restarting the unit. If you attempt to restart before this time delay the unit will not start. When you use the unit for the first time or restart the unit after having been shut off for a long time, there could be a few degrees variance between the temperature you select and the one indicated on the LED readout. This is normal and it is due to the length of the activation time. Once the unit is running for a few hours everything will normalize.

STORING WINE

Many bottles may differ in size and dimensions. The actual number of bottles you are able to store may vary. You can place 18 standard bottles in each zone (or 60 12oz-cans in the beverage zone). Bottle capacities are approximate maximums when storing traditional Bordeaux 750ML bottles and include bulk storage.

DOOR LOCK

Your unit is provided with a lock and key combination. The keys are located inside the plastic bag that contains the owner's manual. Insert the key into the lock and turn it counter clockwise to unlock the door. To lock the door, do the reverse operation while making sure the metal pin is engaged completely. Remove the key and place it in a secure place for safekeeping.

SHELVES

To prevent damaging the door gasket, make sure to have the door completely opened when pulling the shelves out of the rail compartment.

- For easy access to the storage content, you must pull the shelf out of the rail compartment; however this unit was designed with a plastic post on each side of the shelf track to prevent bottles from falling.
- When removing the shelf out of the inner rail, make sure to remove all items first. Then move the shelf to the position where the notch of the shelf is exactly under the plastic post and lift the shelf. In order to replace the shelf, repeat these directions in reverse.

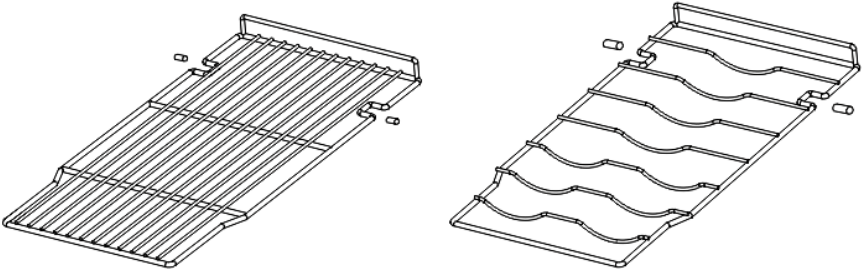

- To ensure maximum performance and efficiency, be sure to place your wine and beverage cooler in an area where there is proper air circulation. Also make sure the plumbing and electrical connections are correct.
- For proper internal air circulation, do not overfill your wine and beverage

cooler.

- Do not place the unit in direct sunlight.
- Do not place heated beverages in your wine and beverage cooler.
- Do not store perishable food in your wine and beverage cooler. The unit's interior temperature may not be low enough to prevent spoilage.
- Do not place heavy objects on top of the wine and beverage cooler.

CLEANING & MAINTENANCE

- Shut off the power supply before cleaning the unit's cabinet.
- Remove all cans and storage shelves.
- Clean the unit's interior with a warm water and neutral detergent solution.
- Thoroughly dry all surfaces.

Please Note:

- Do not use abrasive cleaners to clean the wine and beverage cooler.
- Use mild, soapy water to clean the unit's door seal.
- To ensure efficient operation, also thoroughly clean the back and bottom of the wine and beverage cooler.

TROUBLESHOOTING

Problem	Possible Causes	Solution
The wine and beverage cooler does not cool.	The unit may be plugged in using a different voltage.	Check if using the wrong voltage.
	The circuit breaker may be tripped or there is a blown fuse.	Reset the circuit breaker or check for a broken fuse.
The wine and beverage cooler does not get cold enough.	The unit may be placed too close to a heat source.	Keep the unit away from direct sunlight or other heat sources.
	There is insufficient ventilation.	Place the unit in an area with proper ventilation and clearances.

Problem	Possible Causes	Solution
	The door is not completely closed or the door seal is not working properly.	Close the door tightly. Do not open the door frequently or keep the door open for extended periods.
The wine and beverage cooler seems to make too much noise.	The unit is not leveled or positioned properly.	Adjust the unit's feet and ensure the product is level.
	There is insufficient ventilation.	Allow sufficient clearance around the unit.
	The unit is too close to a wall or other surface.	Allow sufficient clearance around the unit.
An interior red light is flashing.	The set temperature is too low.	Adjust the set temperature so that it is higher than the unit's interior temperature
	The automatic defrost function is working.	Normal function. No repair needed.
Frost is building up in the unit.	There is excess humidity or the interior temperature is too low.	Turn the unit off, unplug it and remove the frost manually. Reconnect once the ice has thawed.

LIMITED MANUFACTURER'S WARRANTY

This appliance is covered by a limited manufacturer's warranty. For one year from the original date of purchase, the manufacturer will repair or replace any parts of this appliance that prove to be defective in materials and workmanship, provided the appliance has been used under normal operating conditions as intended by the manufacturer.

Warranty Terms:

During the first year, any components of this appliance found to be defective due to materials or workmanship will be repaired or replaced, at the manufacturer's discretion, at no charge to the original purchaser. The purchaser will be responsible for any removal or transportation costs.

Warranty Exclusions:

The warranty will not apply if damage is caused by any of the following:

- Power failure
- Damage in transit or when moving the appliance
- Improper power supply such as low voltage, defective household wiring or inadequate fuses
- Accident, alteration, misuse or abuse of the appliance such as using non-approved accessories, inadequate air circulation in the room or abnormal operating conditions (extreme temperatures)
- Use in commercial or industrial applications
- Fire, water damage, theft, war, riot, hostility or acts of God such as hurricanes, floods, etc.
- Use of force or damage caused by external influences
- Partially or completely dismantled appliances
- Excess wear and tear by the user

Obtaining Service:

When making a warranty claim, please have the original bill of purchase with purchase date available. Once confirmed that your appliance is eligible for warranty service, all repairs will be performed by a NewAir™ authorized repair facility. The purchaser will be responsible for any removal or transportation costs. Replacement parts and/or units will be new, re-manufactured or refurbished and is subject to the manufacturer's discretion. For technical support and warranty service, please email support@newairusa.com.

A Name You Can Count On