

INSTALLATION INSTRUCTIONS(optional)

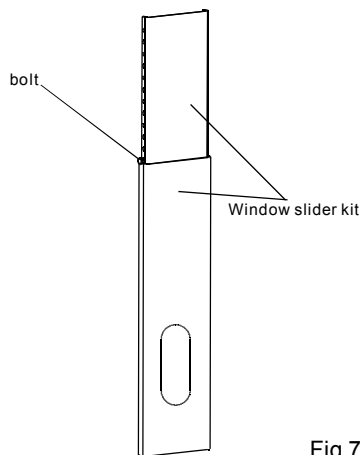
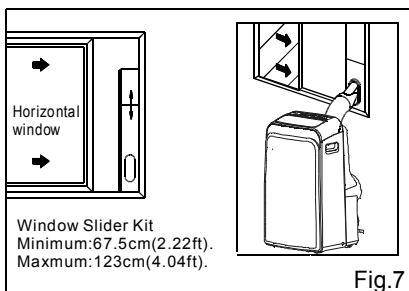
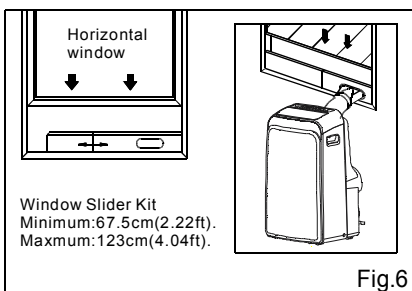
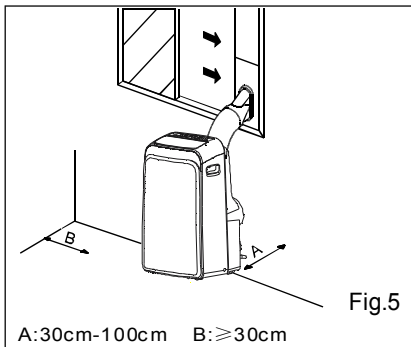

INSTALLATION INSTRUCTIONS

Location

- The air conditioner should be placed on a firm foundation to minimize noise and vibration. For safe and secure positioning, place the unit on a smooth, level floor strong enough to support the unit.
- The unit has casters to aid placement, but it should only be rolled on smooth, flat surfaces. Use caution when rolling on carpet surfaces. Do not attempt to roll the unit over objects.
- The unit must be placed within reach of a properly rated grounded socket.
- Never place any obstacles around the air inlet or outlet of the unit.
- Allow 30cm to 100cm of space from the wall with for efficient air-conditioning.

Window slider kit Installation

Your window slider kit has been designed to fit most standard "Vertical" and "horizontal" window applications, However, it may be necessary for you to improvise/modify some aspects of the installation procedures for certain types of window. Please refer to Fig. 6& Fig.7 for minimum and maximum window openings. Window slider kit can be fixed with a bolt (see Fig.7a).

Note: If the window opening is less than the mentioned minimum length of the window slider kit, cut that one with a hole in it short to fit for the window opening. Do never cut out the hole in window slider kit.

INSTALLATION INSTRUCTIONS(optional)

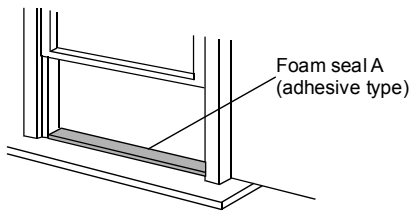

Fig.8

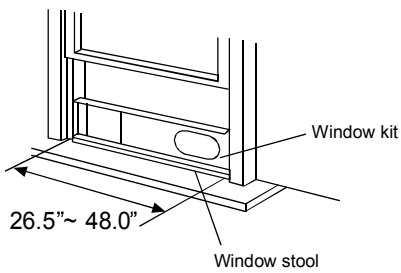

Fig.9

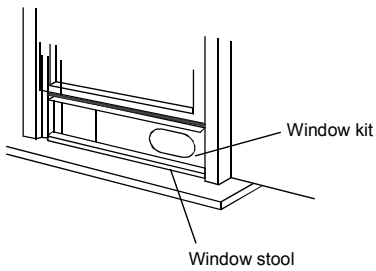

Fig.10

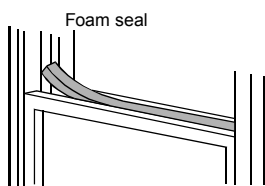

Fig.11

Installation in a double-hung sash window

1. Cut the foam seal(adhesive type) to the proper length and attach it to the window stool. Fig.8
2. Attach the window slider kit to the window stool. Adjust the length of the window slider kit according to the width of window, shorten the adjustable window kit if the width of window is less than 26.5 inches
Open the window sash and place the window slider kit on the window stool. Fig.9
3. Cut the foam seal(adhesive type) to the proper length and attach it on the top of the window. Shown as in Fig.10
4. Close the window sash securely against the window.
5. Cut the foam seal to an appropriate length and seal the open gap between the top window sash and outer window sash. Shown as in Fig.11.

INSTALLATION INSTRUCTIONS(optional)

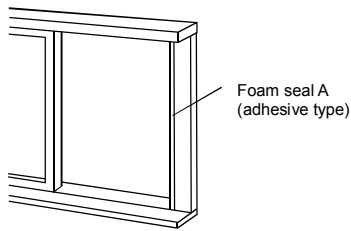

Fig.12

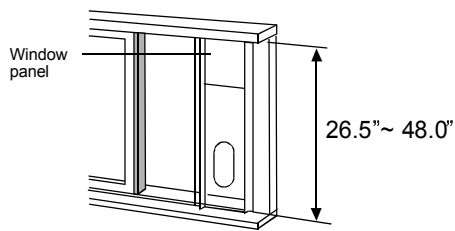

Fig.13

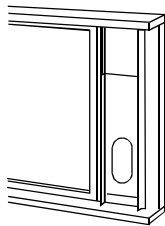

Fig.14

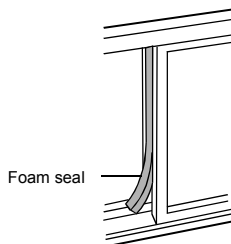

Fig.15

Installation in a sliding sash window

1. Cut the foam seal(adhesive type) to the proper length and attach it to the window frame. See Fig.12.
2. Attach the window slider kit to the window stool. Adjust the length of the window slider kit according to the width of window, shorten the adjustable window kit if the width of window is less than 26.5 inches. Open the window sash and place the window slider kit on the window stool. See Fig.13.
3. Cut the foam seal(adhesive type) to the proper length and attach it on the top of the window. Shown as in Fig.14.
4. Close the sliding sash securely against the window.
5. Cut the foam seal to an appropriate length and sea the open gap between the top window sash and outer window sash. Shown as in Fig.15.

NOTE:All the illustrations in this manual are for explanation purpose only. Your unit may be slightly different. The actual shape shall prevail.

INSTALLATION INSTRUCTIONS

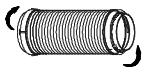

Fig. 16a

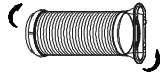

Fig. 16b

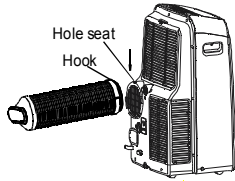

Fig. 17

Exhaust hose installation:

The exhaust hose and adaptor must be installed or removed in accordance with the usage mode.

COOL, HEAT (heat pump type) or AUTO mode	Install
FAN, DEHUMIDIFY or HEAT (electrical heat type)	Remove

1. Install the adaptor B and adaptor I onto the exhaust hose as shown in Fig. 16a or Fig. 16b. Refer to the previous pages for window kit installation.
2. Resert the hook of the Exhaust hose into the hole seat of the air outlet and slide down the Exhaust hose along the arrow direction (See Fig. 17) for installation.

The exhaust hose can be installed into the wall

(Not applicable to the units without adaptor A, expansion plugs and wooden screws of Accessories).

1. Prepare a hole in the wall. Install the wall Exhaust adaptor A onto the wall (outside) by using 4 expansion plugs and wooden screws, be sure to fix thoroughly. (See Fig. 18)
2. Attach the Exhaust hose to wall Exhaust adaptor A.

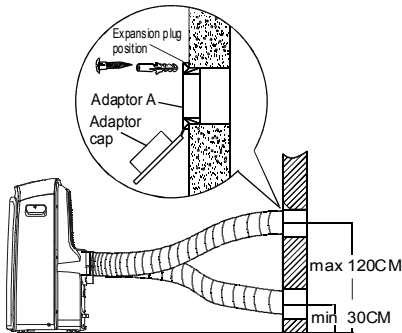

Fig. 18

Note:

Cover the hole using the adaptor cap when not in use.

- The exhaust hose can be compressed or extended moderately according to the installation requirement, but it is desirable to keep the hose length to a minimum.

IMPORTANT:

DO NOT OVER BEND THE EXHAUST HOSE (SEE Fig. 19)

⚠ CAUTION:

Make sure that there is no obstacle around the air outlet of the exhaust hose (in the range of 500mm) in order to the exhaust system works properly.

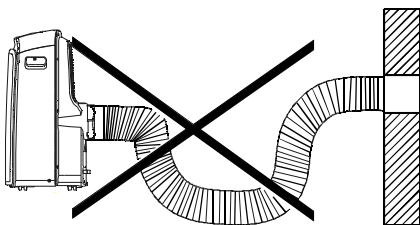

Fig. 19

INSTALLATION INSTRUCTIONS

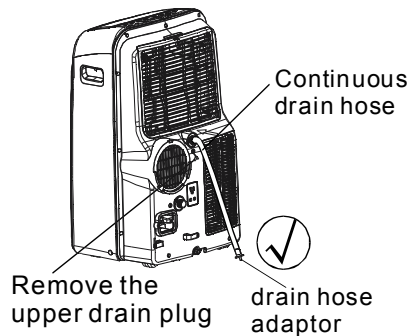

Fig.20a

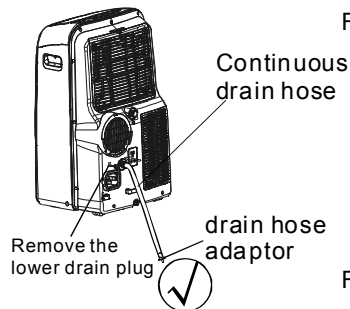

Fig.20b

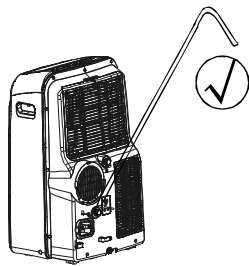

Fig.21a

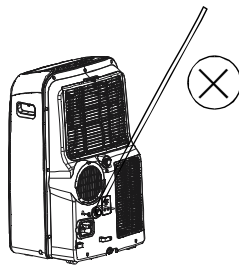

Fig.21b

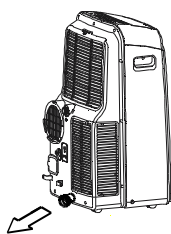

Fig.22

Water drainage:

- During dehumidifying modes, remove the upper drain plug from the back of the unit, install the drain connector(5/8" universal female mender) with 3/4" hose(locally purchased). For the models without drain connector, just attach the drain hose to the hole. Place the open end of the hose adaptor directly over the drain area in your basement floor. Please refer to Fig.20a.
- During heating pump mode, remove the lower drain plug from the back of the unit, install the drain connector(5/8" universal female mender) with 3/4" hose(locally purchased). For the models without drain connector, just attach the drain hose to the hole. Place the open end of the hose adaptor directly over the drain area in your basement floor. Please refer to Fig.20b.
NOTE: Make sure the hose is secure so there are no leaks. Direct the hose toward the drain, making sure that there are no kinks that will stop the water flowing. Place the end of the hose into the drain and make sure the end of the hose is down to let the water flow smoothly.(See Fig.20a,20b,21a). Do never let it up.(See Fig.21b).
- When the water level of the bottom tray reaches a predetermined level, the unit beeps 8 times, the digital display area shows "P1" . At this time the air conditioning/dehumidification process will immediately stop. However, the fan motor will continue to operate(this is normal). Carefully move the unit to a drain location, remove the bottom drain plug and let the water drain away(Fig.22). Reinstall the bottom drain plug and restart the machine until the "P1" symbol disappears. If the error repeats, call for service.
NOTE: Be sure to reinstall the bottom drain plug before using the unit.