

1. The product stored with S hook locked.

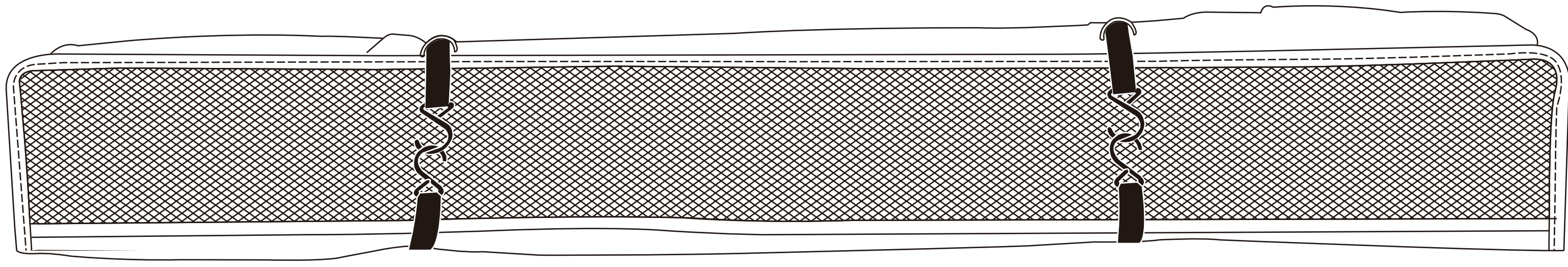

2. Open S-hook.

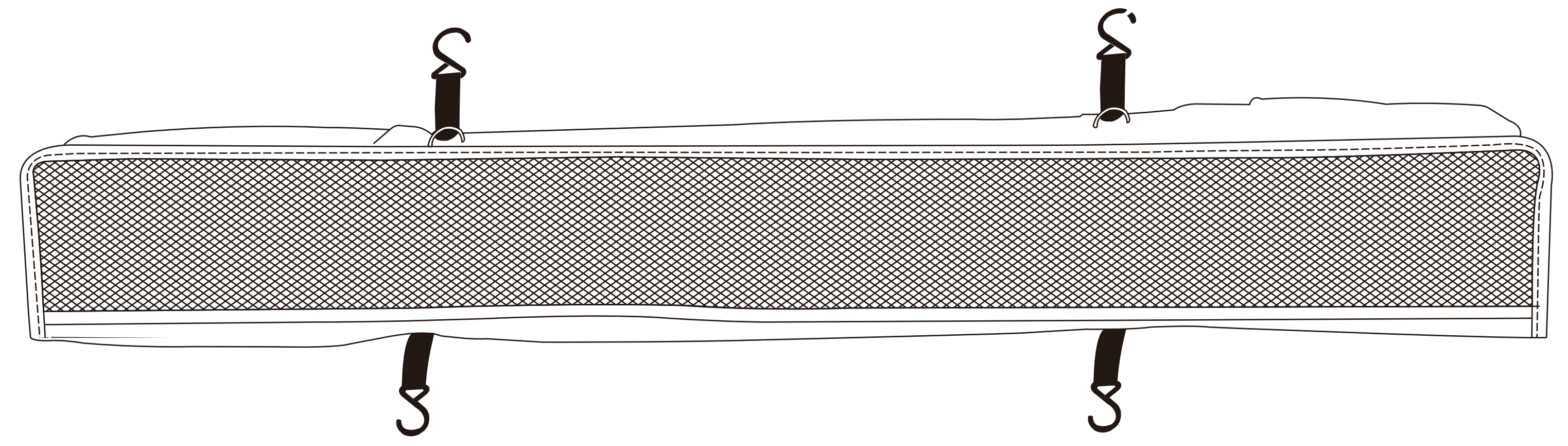

3. The gun bag can be disassembled

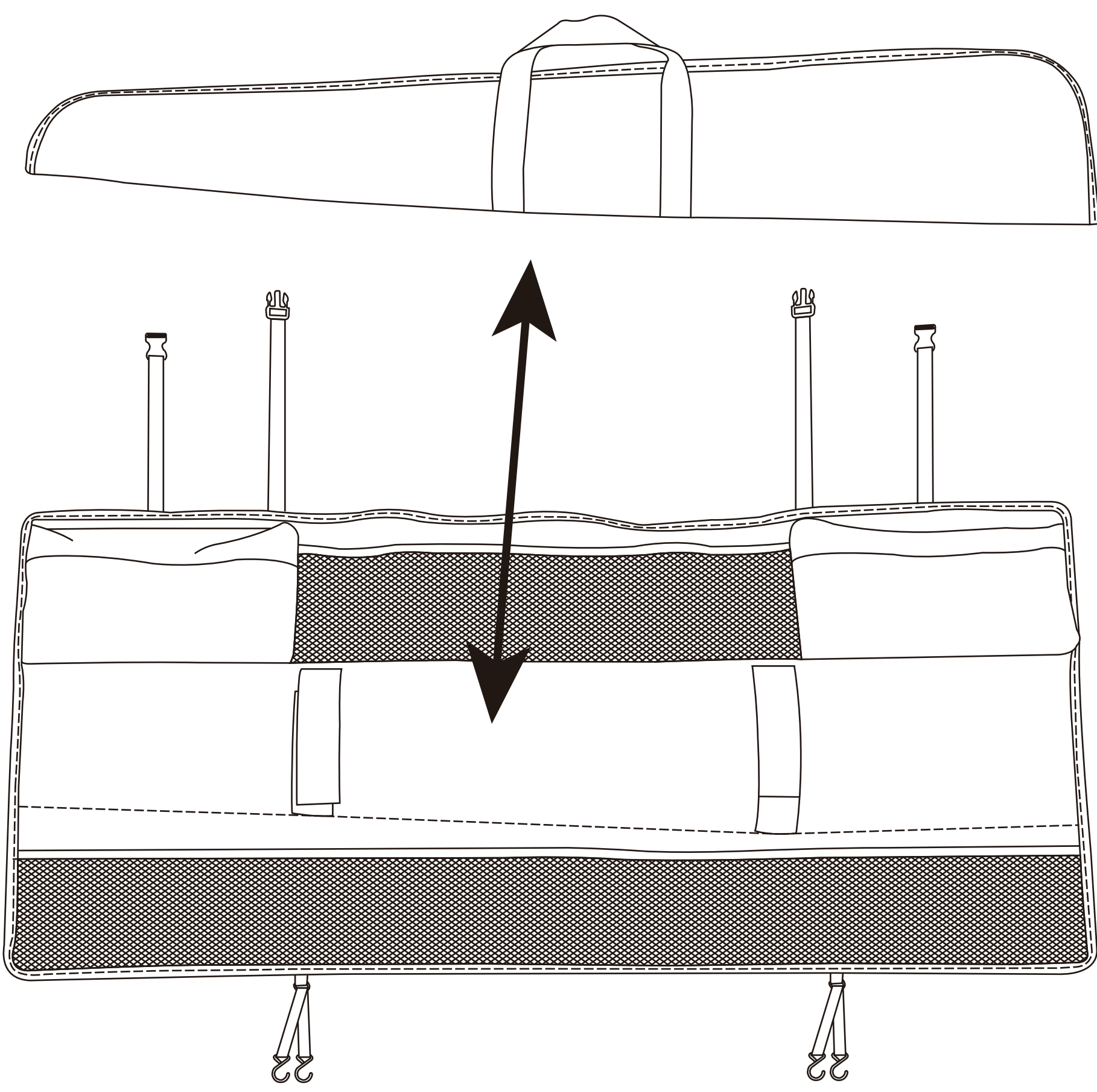

4. Find the fitting belt in the top of product.

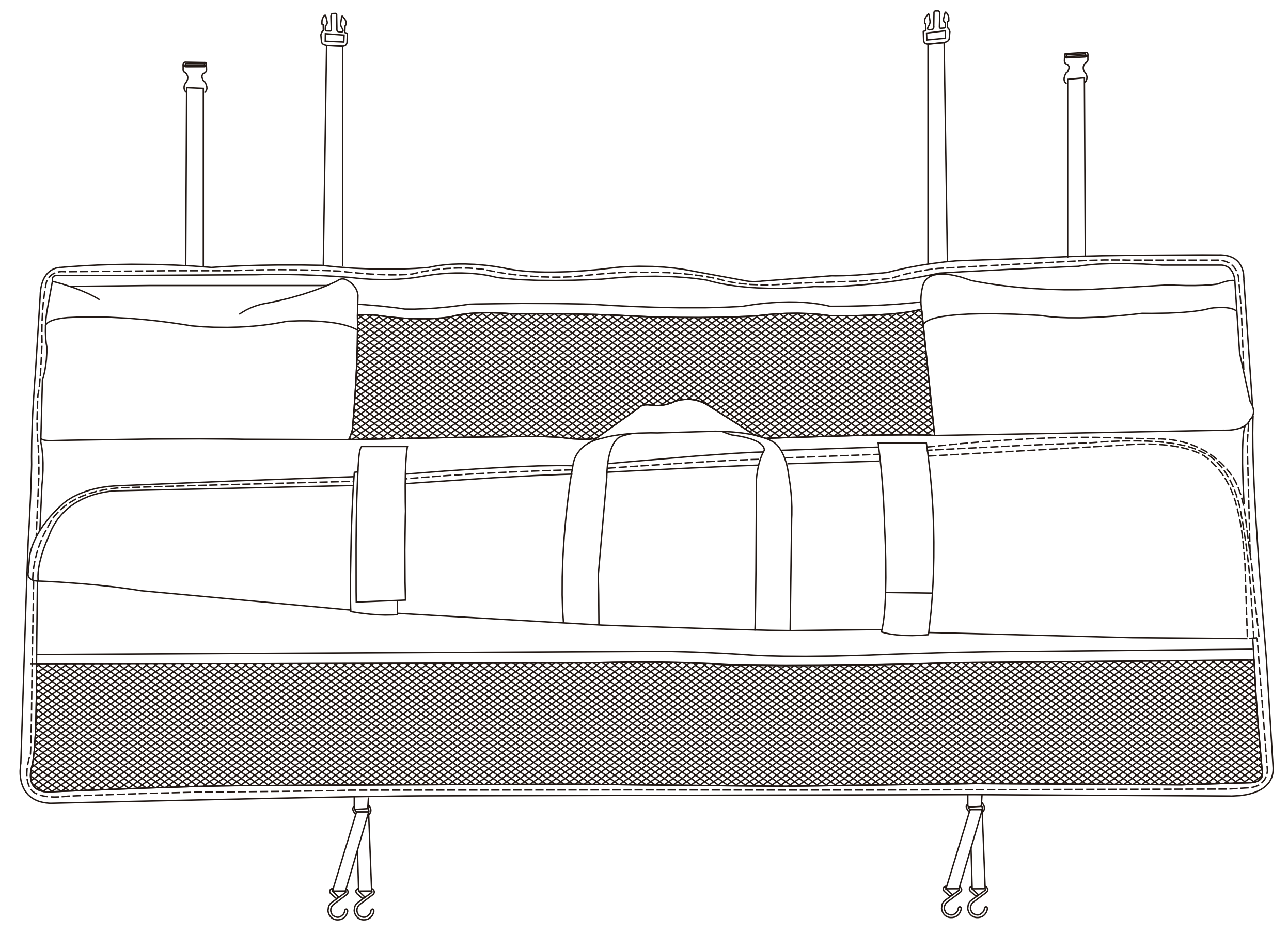

5. Surround headrest of car backseat.

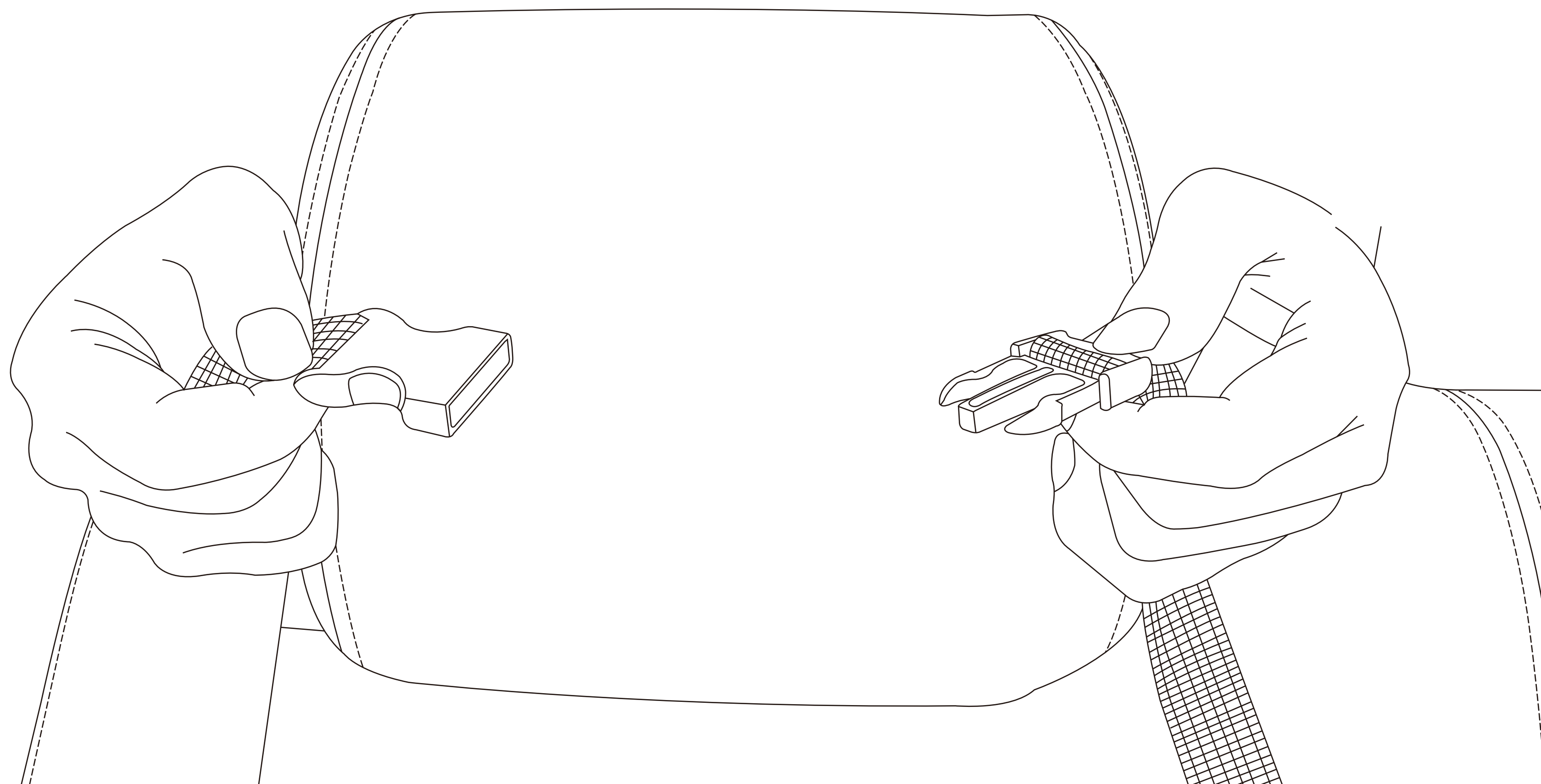

6. Insert clip and fasten the belt.

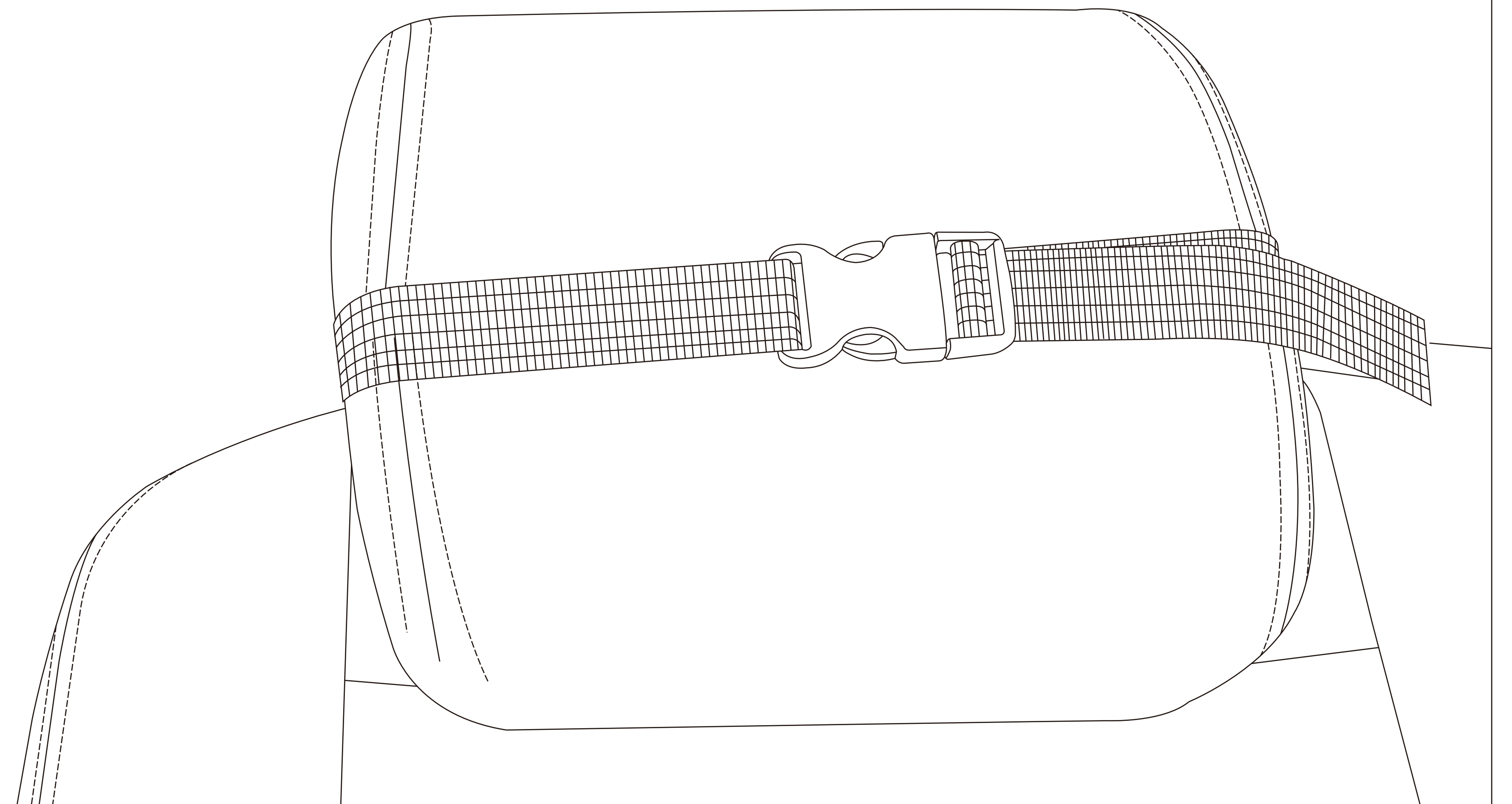

7. Repeat step 5 & 6.

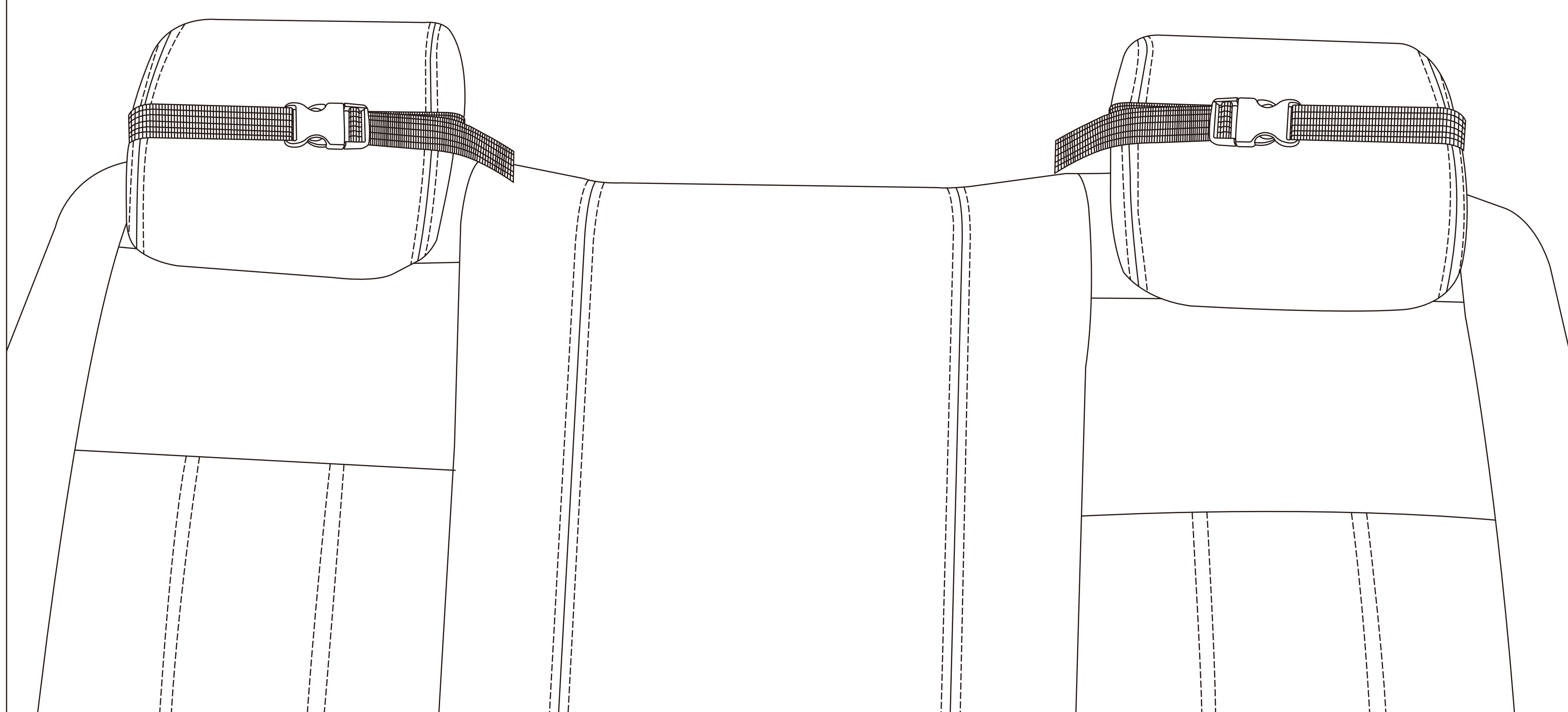

8. Make sure the Gun Rack hang smoothly at the back of backseat.

