



HitchMate®

Version 150401

TruckStep & TruckStepXL Instructions for Use

BEFORE YOU BEGIN

To ensure the best service and satisfaction from your HitchMate®, please read and follow all instructions, recommendations, and warnings. Heininger Holdings, LLC is not responsible for damage or injury due to misuse of the *TruckStep* product. And we always want to hear from you about our products and service. Contact us at info@heininger.biz.

VERIFY ALL PARTS ARE INCLUDED IN PACKAGE:

- 1-TruckStep or TruckStepXL which is fully assembled and it includes pin or the anti-wobble device (XL)

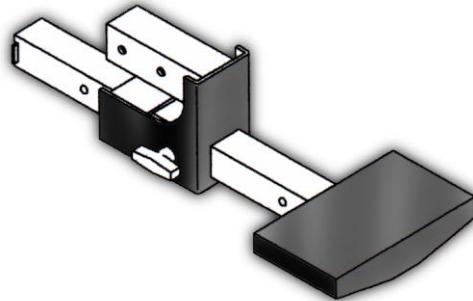

Installing Your TruckStep or TruckStepXL

It is fully assembled therefore all you need to do is align the hole in the receiver insert correctly with the hole in the receiver. We purposely put 2 holes in this insert due to the variables in the placement of receiver hitch appliances. Once properly aligned (try to use the hole furthest from the 2 x 2 tube end to lessen the amount of leverage for the carrier), make sure the anti-wobble insert is also aligned with this same hole. It can be easily slid fore/aft to align the nut threads with the hole. With the washer on the bolt, feed the 5/8" bolt into the side the nut is closest and tighten very well. Nothing is to be "finger-tight."





HitchMate®

Quick-Tips on the use of your HitchMate TruckStep

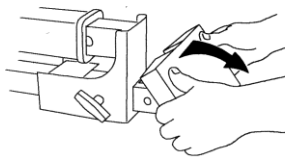
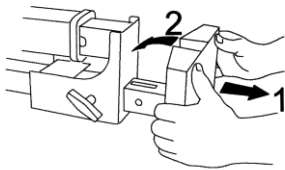
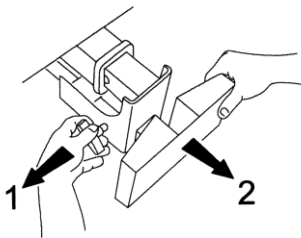

1.) To use the TruckStep as a step for reaching in close to the truck bed or SUV, extend the step out until it stops in the first extended position. First pull the T-handle and pull the step toward you.

2.) Lower the step into place and insure it is safely locked in position before stepping on the TruckStep. Like the center drawing shows, pull out on the lower portion of the vertical step and roll it like the arrow shows (use your thumbs), while still pulling on the lower portion. Once near level, allow the spring to pull the step forward, away from you as it locks into place.

3.) For use with the tailgate in the flat position, simply pull the T-handle and extend the step out until it stops in the fully extended position. To close, simply pull the T-handle and

collapse the step into the stationary position and repeat in reverse, the first step. (Note: for the TruckStepXL there are 2 extension stop points designed for the longer tailgates now in use.)

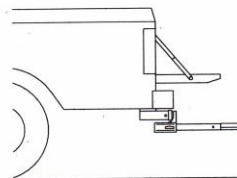
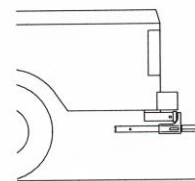
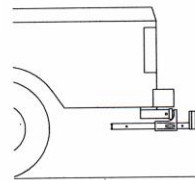
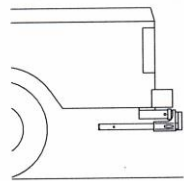

Please share & show your use of the *TruckStep* by uploading photo/comments onto the **HitchMate** Facebook page.

Be responsible. Let it live forever... *We are all responsible for the environment. Do your part to keep the water clean, the air pure and the forests green. Reduce, reuse & recycle when you should, not just when it is convenient.*



Rules of the Road on the Use of Your HitchMate® TruckStep or TruckStepXL:

Be safe; take time before travel to make sure the step is securely fastened and in proper order.

- Before you drive, with your vehicle in PARK, make sure every bolt and nut are tight and securely in place.
- Never use the step on a towed vehicle
- Do not use this product for anything other than for that which it was designed.
- Do not operate vehicle when the TruckStep is not in a secure position.
- If you use a hitch-lock to lock the step on the vehicle make sure you keep it well-oiled and the key is stored properly
- Always check travel-lock to insure it is secure before and during your travels.
- Please call our toll free number, 888-722-5240, with any questions you have about this product.

Care and Maintenance

- As an extra precaution, we recommend you double check the hitch bolt (or pin) and all *TruckStep* fasteners once a month (and every time you reinstall it, whichever is more often) to ensure everything is securely fastened and attached correctly. Address anything that has loosened or shifted over time with vehicle/road vibration.
- When not in use but on the vehicle, raise step to the vertical position to avoid a hazardous walk-around
- For proper operating performance, we recommend you clean your *TruckStep* from time to time with soap and water, to ensure salt, sand, grit and other debris do not interfere with *TruckStep*'s smooth operation. In winterized-salty conditions, wash the *TruckStep* thoroughly and often.
- Routine lubrication of *TruckStep* is required around the T-handle shaft to ensure the knob moves easily. Apply to the moving/sliding points on the step to maintain the step rotates with ease. Use 3-In-One® Oil generously and often.



3-IN-ONE.

For more information on 3-In-One Oil, please visit www.3inone.com

Replacements are available by calling Heininger Holdings:

Item/Product	Description	Price with Handling-shipping
#6039 Anti Wobble Kit (for 2 x 2 receiver tube only)	Nut, bolt, washer and anti-wobble block	\$17.95
#6001 Hitch Lock	Anti-wobble lock rack/vehicle (5/8" x 11 thread)	\$29.95



- **WARNING! - DO NOT USE ON A TRAVEL TRAILER, 5TH WHEEL, OR TOWED VEHICLE**
- **WARNING! - USE CAUTION WHEN ENTERING STEEP DRIVEWAYS AND GOING OVER SPEED BUMPS**
- **WARNING!** Do not exceed load rating for the hitch-mounting bracket specified by its manufacturer. Consult hitch-mounting manufacture for load limit if not shown on mount or in the vehicle literature. This appliance has been designed to attach securely to a primary vehicle. It is not compatible with travel trailer, fifth wheel or RV applications. The user of this product must secure it properly to the vehicle and regularly inspect for tightness, wear and/or damage. The Manufacturer is not responsible for and does not guarantee the attachment of this carrier to any vehicle, and is not liable for any damages resulting from its attachment. **The liability of Heininger Holdings, LLC, is limited to only the purchase price of the TruckStep.** Be aware that some countries/states/provinces require an unobstructed view of the vehicle license plate. If this step obstructs the plate, you may need to relocate your license plate. Consult your local vehicle code for restrictions and rules.

Limited Liability One Year Warranty Policy

Heininger Holdings, LLC, warrants the original owner of each new HitchMate product against defects in workmanship and materials, provided it is purchased from an authorized HitchMate dealer for one year from date of purchase. This Limited Warranty is not transferable and shall only apply to normal and ordinary use, for which the product was intended.

Warranty claims are to be made directly to Heininger Holdings and must be accompanied by a sales receipt or other appropriate proof-of-purchase document. Should this product or any part or accessory be determined by Heininger Holdings, to be defective and covered by this Limited Warranty, it will be repaired or replaced at the option of Heininger Holdings, without further charge. The cost of transportation to and from the Heininger warranty inspection facility for repair or replacement of any defective part and/or accessory and any related charges is not covered by this warranty, and is to be paid by the owner.

The warranty does not cover normal wear and tear, worn and normal use cosmetic blemishes, improper assembly, improper application, lack of maintenance, or custom alteration/installation of any parts or accessories not originally intended or compatible with the product as sold. The warranty does not apply to damage or failure resulting from an accident, abuse or neglect.

This warranty is given in lieu of all other expressed warranties, implied warranties, including without limitation implied warranties of merchandising ability and fitness for a particular purpose, and are limited to the duration and specification of this warranty. In no event shall Heininger Holdings, be liable for damages in excess of the purchase price of the HitchMate TruckStep, for any loss of use, loss of time, inconvenience, commercial loss, lost profits or savings or any incidental, special, consequential, direct or indirect damages arising out of the use or inability to use such product, to the full extent as such may be disclaimed by the law. Labor charges for part changeover are not covered by this warranty