

FLEXI GATE

WITH SMALL PET DOOR

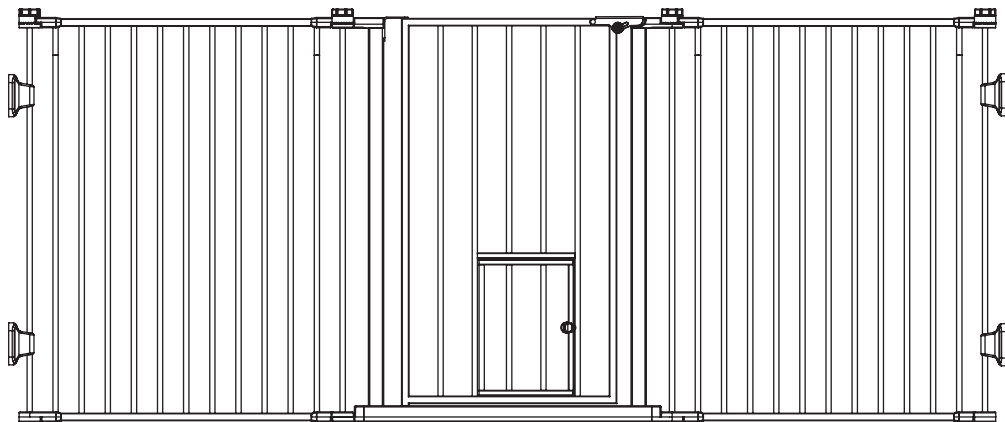

- READ ALL INSTRUCTIONS BEFORE ASSEMBLY AND USE OF GATE.
- KEEP INSTRUCTIONS FOR FUTURE USE.

 www.carlsonpetproducts.com

 Carlson Pet Products, Inc.
3200 Corporate Center Drive, Suite 105 | Burnsville, MN 55306, USA

 952.435.1084

Made in China

Before Using Product

Read and follow all instructions carefully to ensure that your gate and extensions are properly installed. Improper installation could result in the gate becoming unstable or dislodged from the doorway. Please keep these instructions for your reference.

IMPORTANT

- The four mounting brackets must be used in securing the gate to the wall. These brackets prevent the gate from dislodging from its opening and becoming unstable.
- If hardware mounting to a surface other than drywall or wood, please consult with a professional about installation.
- The maximum width opening for this gate is 76 inches.



WARNING

- To prevent serious injury or death, securely install gate or enclosure and use according to manufacturer's instructions.
- Check the gate regularly to see if all the hardware and mountings are tightened.
- This is a Pet Gate. NOT intended for use with children.
- This is a Pet Gate, but when used with children the small pet door must remain closed and securely latched.
- Strangulation hazard: pets can force themselves into very small openings; use this gate with pets whose heads will not fit into openings in the gate, between the gate and floor, or between the gate and wall.
- Never use with pet able to climb over or dislodge/open the gate or enclosure.
- Never leave pet unattended.
- Use only with the locking/latching mechanism securely engaged.
- To prevent falls, NEVER use at the top of stairs.
- This gate is designed to fit maximum width openings 76 inches.

Before Assembly

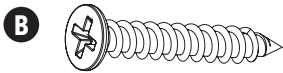
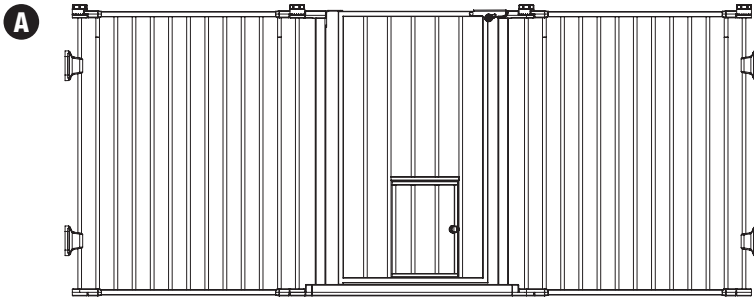

PLEASE CHECK TO MAKE SURE YOU HAVE THE FOLLOWING PARTS:

- A** *Folded Gate Frame and attached Wall Mounting Assembly (1)*
- B** *Wall Mounting Screws (8)*

ADDITIONAL EXTENSIONS (SOLD SEPARATELY)

GATE MODEL	EXTENSION MODEL
1510 (INCLUDES 2 PANELS)	0030
1510HPW (INCLUDES 2 PANELS)	0038

Assembling and Installing Your Gate

STEP 1

Unfold the gate frame by turning the *locking knobs* counter clockwise at each pivoting joint. Loosen the knobs enough to allow the gate to swing open freely without fully removing the knobs.

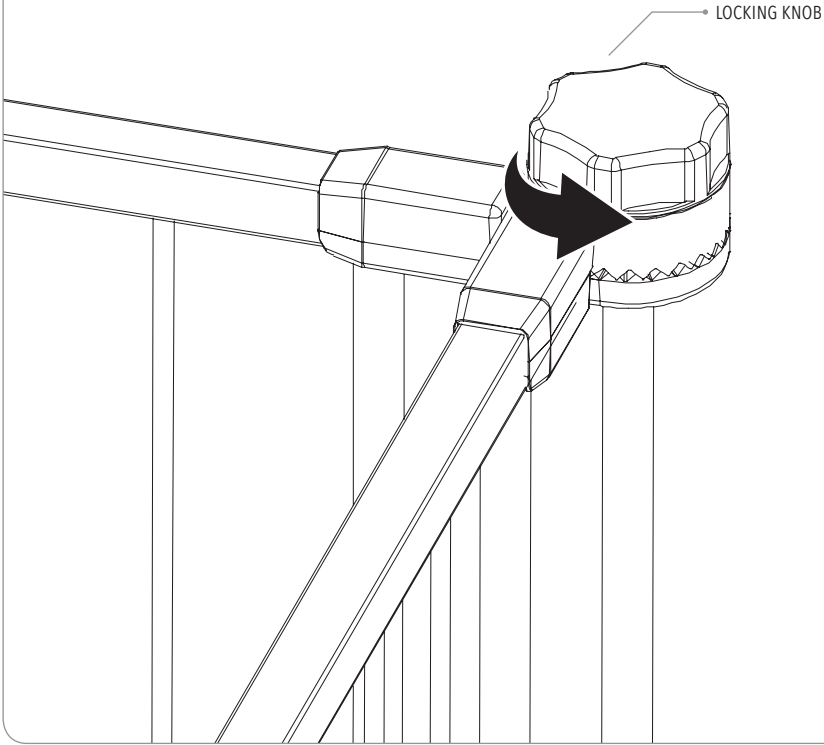

STEP 2

Use a Phillips/cross-head screwdriver to fix the *wall mounting bracket* to the wall. Repeat for all four brackets.

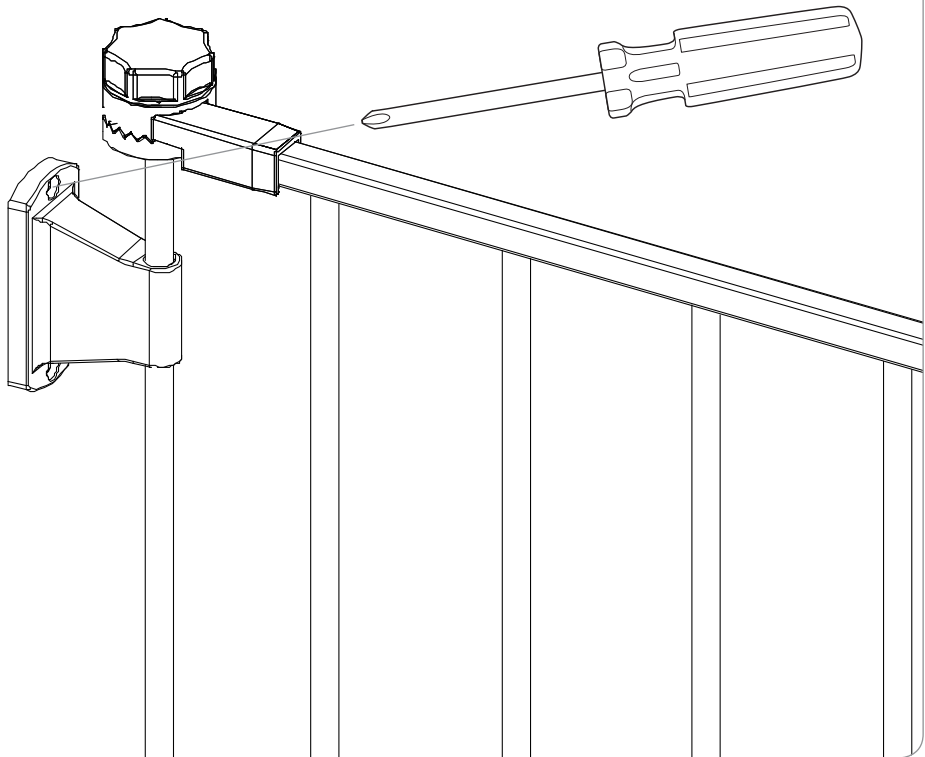

STEP 3

Arrange the panels to your desired configuration, then tighten all four of the *locking knobs*.

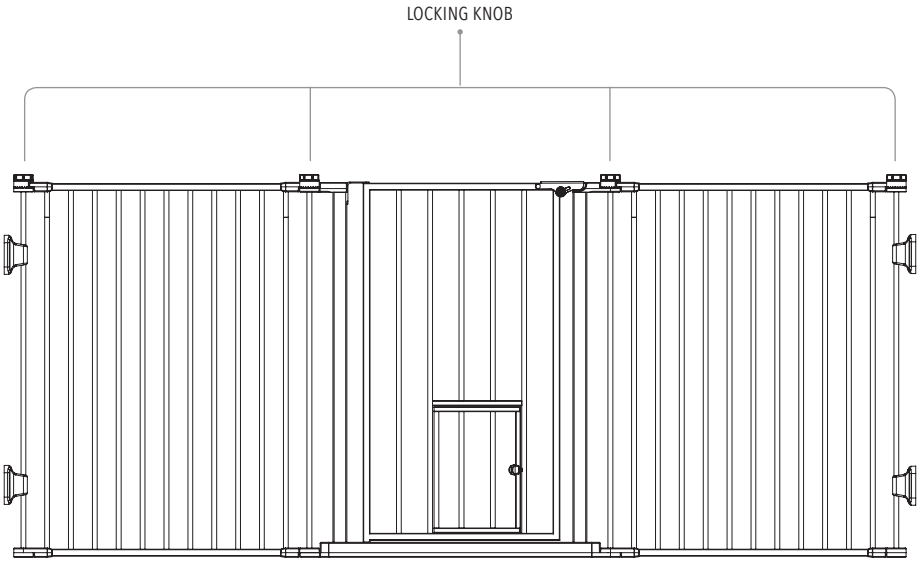

Operating the Door Latch

STEP 1

Push both sides of the *slide lock* upwards along the slotted opening while simultaneously pulling upwards on the *metal lift latch* until the latch raises above the gate's door frame.

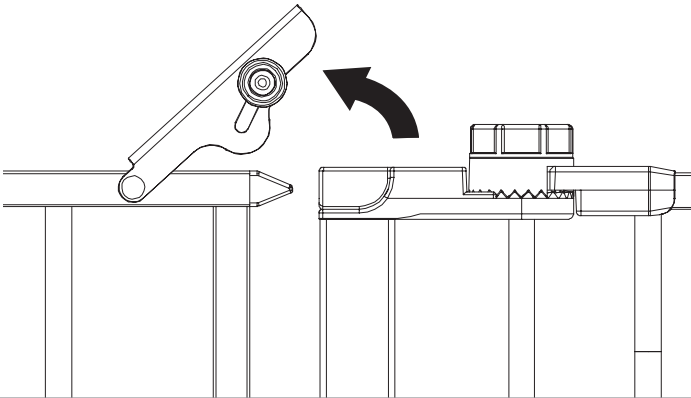
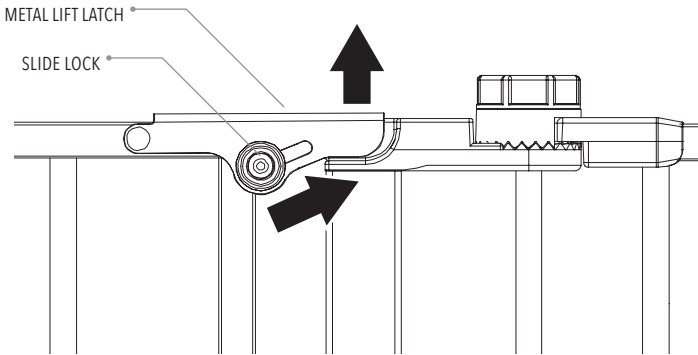

STEP 2

To re-lock the gate, close the door completely and drop the *metal lift latch* back into place. The *slide lock* will return to its locked position on its own.

SMALL PET DOOR

To use the small pet door, pull back on the *spring pin*.

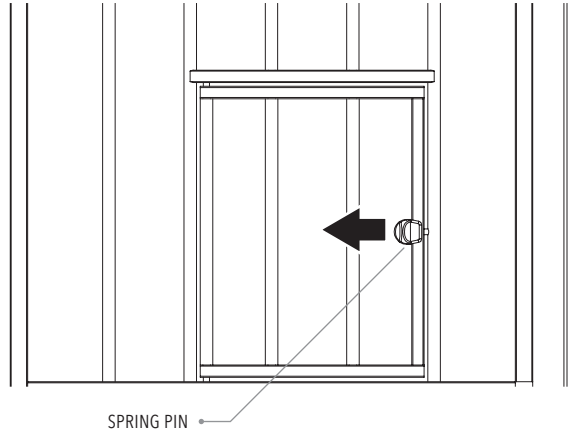

CARE AND MAINTENANCE

Periodically check the gate for signs of damage, wear, or missing components. Do not use if any part is missing, worn or damaged. Check the gate regularly to ensure all the hardware and mountings are tightened. Do not use abrasive cleaners or bleach. Clean by sponging with warm water and a mild detergent.

90 DAYS LIMITED WARRANTY

If, during the first 90 days after consumer purchase of the item, under reasonable and non-commercial use and conditions of maintenance, it fails while owned by the original purchaser because of the quality of materials or workmanship of finish and assembly, Carlson Pet Products, Inc. will replace or repair it at Carlson's option. PROOF OF PURCHASE REQUIRED.

Replacement Parts

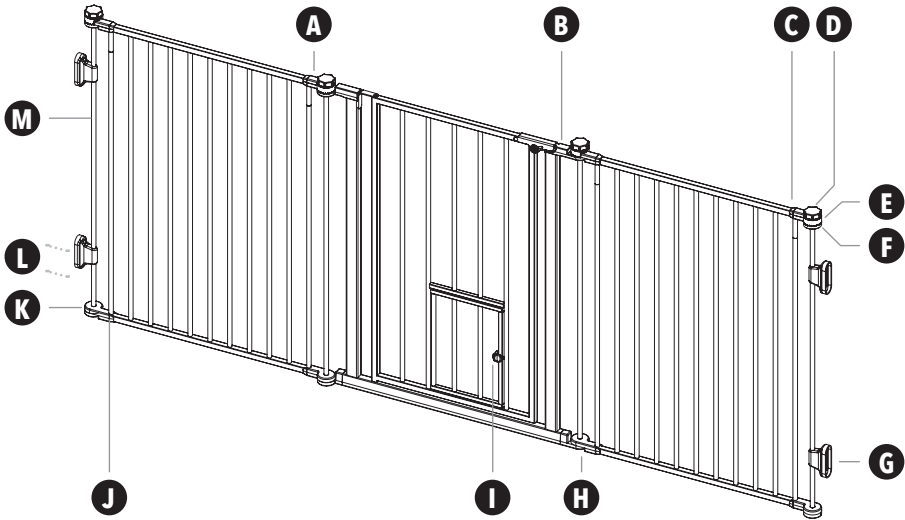

A **Door Frame Toothed Hinge**
White = #13009



B **Door Frame Receiving Hinge**
White = #13129



C **Top Hinge**
White = #13011



D **Locking Knob**
White = #13015



E **Toothed Disk**
White = #13023



F **Wall Mount Toothed Disk**
White = #13013



G **Wall Mount Bracket**
White = #13007



H **Door Frame Bottom Hinge**
White = #13004



I **Pet Door Pull Lock**
White = #13038



J **Bottom Hinge - Male**
White = #13002



K **Wall Mount Bottom Cap - Female**
White = #13014



L **1" Wall Mount Screws**
#10001



M **37" Metal Pivot Bar**
White = #13021





www.carlsonpetproducts.com



Carlson Pet Products, Inc.
3200 Corporate Center Drive, Suite 105
Burnsville, MN 55306, USA



952.435.1084