



1 YEAR LIMITED WARRANTY

Metal Detector

WINBEST® by BARSKA®, as manufacturer, warrants this new product to be free of original defects in materials and/or workmanship for the length of time specified by this warranty. This warranty does not include damage caused by abuse, improper handling, installation, maintenance, normal wear-and-tear, unauthorized repairs or modifications and tampering in anyway.

This warranty is limited to the original purchaser and is not transferable. This warranty applies only to products purchased in the United States of America and Canada.

In the event of a defect within 30 days, the consumer must return the defective unit to the WINBEST® by BARSKA® dealer (the place of purchase) at his/her own expense.

Beyond 30 days, WINBEST® by BARSKA® products should be sent to the following address for warranty repairs. Products must be packed carefully and sturdily to prevent damage in transit, and returned freight prepaid to:

WINBEST® by BARSKA®
855 Towne Center Drive
Pomona, CA 91767

For additional and updated information
please visit www.barska.com

Please email info@barska.com or call 1.888.666.6769 for Return Merchandise Number (RMA#) before any returns.

NOTE: All merchandise received without a valid RMA# will be returned to shipper at his/her own expense.

Please include all of the following when returning WINBEST® by BARSKA® products for service and/or replacement:

1. Please write your complete details (Name, Address, Telephone #, E-mail address, RMA#, etc.)
 2. Purchase receipt or Proof of Purchase. (Original/Copy)
 3. A brief explanation of the defect
 4. A Check/Money Order of \$25.00 to cover inspection, shipping and handling
- *Please allow 6-8 weeks for delivery

This product will either be replaced or repaired at the discretion of the warrantor. If it's a discontinued item, we will replace the product with an equivalent product. Should the repair not be covered by this warranty, an estimate will be sent for your approval. Non-warranty repairs or refurbishing are always provided at a reasonable cost.

WINBEST® by BARSKA® shall not be liable for any consequential, incidental and/or contingent damages whatsoever. We will not pay shipping, insurance or transportation charges from you to us, or any import fees, duties and or taxes. This warranty supersedes all previous Winbest® by BARSKA warranties.



Pro Edition Metal Detector



ALL METAL – Lets you search for all different types of metal with auto ground balance and high sensitivity. It's the best operation mode.

DISC – Discriminates what kind of metal is being detected.

Volume – To adjust the volume level of speaker and headphone

Earphone Jack – Lets you connect headphones (not supplied) to the detector.

View Meter and Pointer – The meter pointer swings to the right if metal is found.

Waterproof Search Coil – Lets you search for metal objects under shallow water. Note: The search coil is waterproof, but the control housing is not.

Adjustable Stem – Lets you adjust the detector's length.

Operates on two 9V alkaline batteries (not supplied).

CONTENTS

Features	3
Preparation	4
Parts of the Detector	4
Assembling the Detector	4
Adjusting the Search Coil	5
Installing the Batteries	5
Using the Headphones	6
Functions and Indications	6
Parts of the Control Box	6
Operation	7
Testing and Using the Detector	7
Search Coil Sweeping Hints	8
Factors That Affect Detecting	8
Care and Maintenance	9
Warranty	10

FEATURES

With your metal detector, you can hunt for coins, relics, jewelry, gold, and silver just about anywhere. This metal detector is versatile and easy to use. Features include:

Two Operation Modes: All Metal, Disc

ALL METAL

Lets you search for all different types of metal with auto ground balance and high sensitivity. It's the best operation mode.

DISC

Discriminates what kind of metal is being detected.

Volume – To adjust the volume level of speaker and headphone

Earphone Jack – Lets you connect headphones (not supplied) to the detector.

View Meter and Pointer – The meter pointer swings to the right if metal is found.

Waterproof Search Coil – Lets you search for metal objects under shallow water.
Note: The search coil is waterproof, but the control housing is not.

Adjustable Stem – Lets you adjust the detector's length.

Operates on two 9V alkaline batteries (not supplied).

TREASURE HUNTER'S CODE OF ETHICS

A few basic rules you should follow while using your detector

- Always get permission before searching any site
- Respect the rights and property of others
- Observe all national, state and local laws when treasure hunting
- Never destroy historical or archaeological treasures. If you are not sure about an object you have found, contact a museum or historical society in your area.
- Leave the land and vegetation as is, and fill in any holes you dig.
- Use the detector only in safe areas
- Dispose of any junk you may find, only in approved areas. Do not leave it for the next treasure hunter find.

PARTS OF THE DETECTOR

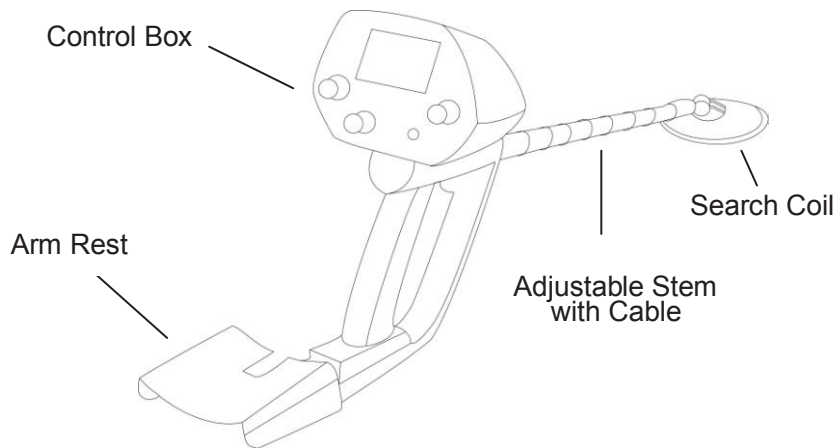

PREPARATION

ASSEMBLING THE DETECTOR

Assembling the detector is easy and requires no special tools. Just follow these steps.

1. Unscrew the knobs on the search coil and remove the knobs and the connector. Insert the smaller stem and align the holes on the search coil bracket and the stem. Push the connector through the holes, then replace and tighten the knobs.

2. Loosen the stem's lock nut (connected with the handle) in the direction of the arrow. Then insert the smaller stem into the big stem connected with the handle. Turn the stem's lock nut in the reverse direction of the arrow to lock it in place.

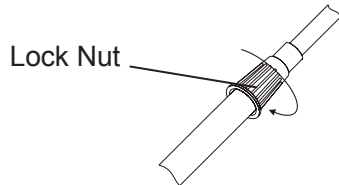

3. Insert the latch on the top of the handle into the assembly hole on the bottom of the control box. Then slightly push the control box in the direction of IN on the handle to fix the latch in place.

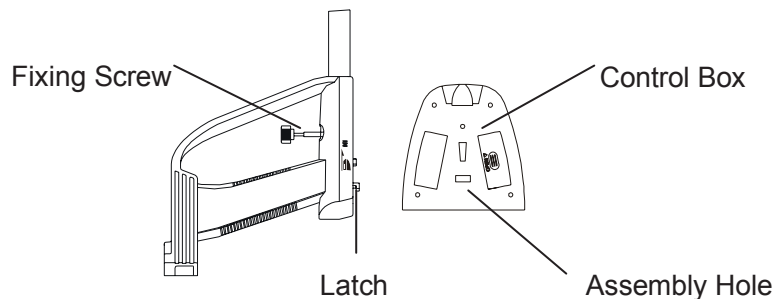

4. Tighten the fixing screw.

5. Insert the search coil cable plug into the five pin jack on the front control box's housing.



6. Lengthen or shorten the stem, so when you stand upright with the detector in your hand, the search coil is level with and about .5~2 inches / 1~5cm above the ground. After that tighten the lock nut.

Caution:

- The search coil cable plug fits into the connector only one way. DO NOT force the plug or you could damage it.
- DO NOT disassemble the stem lock nut. In case you disassemble it, place the washer on the top of the stem connected with the handle with the small head of the washer upwards. Then hitch the stem lock nut on the washer then tighten it to lock it in place.

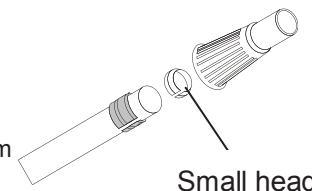

ADJUSTING THE SEARCH COIL

Loosen the knobs at the search coil's end, adjust the search coil to the desired angle. (The search coil should be parallel with the ground.) Tighten the knobs just enough to keep the search coil from rotating or wobbling.

INSTALLING THE BATTERIES

You need two 9V alkaline batteries to power your detector.

1. If the detector is on, turn the power switch (on the control panel) to POWER OFF.
2. Press on the battery compartment cover and slide the cover off in the direction of the arrow.
3. Connect the battery with the battery connector taking care of the polarity. Then put the battery into the compartment.
4. Replace the cover.

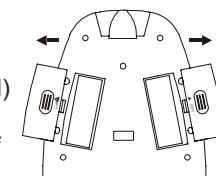

Cautions:

- Use only fresh batteries of the required size and recommended type.
- Always remove old or weak batteries; batteries can leak chemicals that can destroy electronic parts.
- If you do not plan to use the detector for a long time, remove the batteries.
- Dispose of old batteries promptly and properly.

You can extend battery life by using earphones, which require less power than the built-in speakers.

USING HEADPHONES

You can connect a pair of headphones (not supplied) to the detector so you can listen privately. Using earphones also saves battery power and makes it easier to identify subtle changes in the sounds you hear, for better detection results.

To connect earphones to the detector, insert the earphone's 3.5mm plug into the EAR jack on the control panel.

Note: The detector's internal speaker disconnects when you connect earphones.

Listening Safely

To protect your hearing, follow these guidelines when you use earphones.

- Set the volume to the lowest setting before you begin listening.
- After you begin listening, adjust the volume to a comfortable level.
- Do not listen at extremely high volume levels. Extended high volume listening can lead to permanent hearing loss.
- Once you set the volume, do not increase it. Over time, your ears adapt to the volume level, so a volume level that does not cause discomfort might still damage your hearing.

Traffic Safety

DO NOT wear headphones while operating your detector near high-traffic areas. Even though some earphones are designed to let you hear some outside sounds when listening at normal volume levels, they still can present a traffic hazard.

FUNCTIONS AND INDICATORS

PARTS OF THE CONTROL BOX

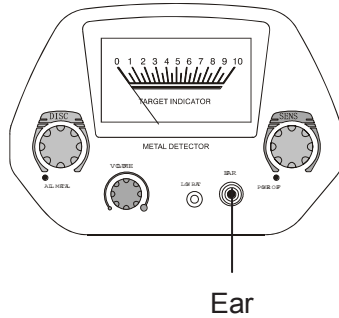
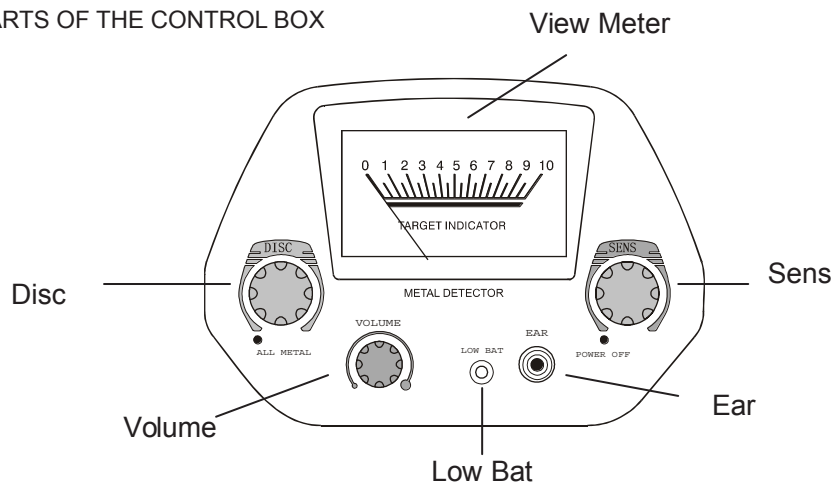

- a. DISC—Rotate the control clockwise away from ALL METAL to get DISC mode. The DISC mode comes with auto ground balance. Rotate the control slowly and clockwise to eliminate different trash objects.

Rotate the control counter clockwise to the end to get ALL METAL mode. All METAL also comes with auto ground balance. It's used to find not only ferrous metal, but also non-ferrous one (see more details below).

- b. SENS—Rotate the control counter clockwise to the end to power off the unit. Rotate the control clockwise to power on the unit. Continue rotating it clockwise to get higher sensitivity.
- c. VOLUME—Rotate the control clockwise to get higher level or to get lower volume level by rotating it counter clockwise.
- d. LOW BAT—Low battery indicator. When LOW BAT indicator lights, user should replace the batteries at once.
- e. EAR— 3.5mm headphone jack for connecting headphones.
- f. VIEW METER—When unit finds any metal target, the meter pointer swings to the right.

TESTING AND USING THE DETECTOR

This metal detector has two operation modes: ALL METAL & DISC.

- ALL METAL - is used to find all kinds of metal targets.
- DISC - Is used to discriminate the metal type.

Set the operation mode to ALL METAL, DISC to counter clockwise end, SENS to high position. Then hold the search coil parallel with the ground about .5~2 inches / 1~5cm above the surface. Sweep the search coil from side to side in an arc line of 2.75 inches / 7cm motion.

When the detector detects a buried target, it sounds a tone. Make a visual note of exact spot on the ground where the detector beeps. Then stop the search coil directly over this point on the ground. Move the search coil straight forward away from you and straight back towards you a couple of times.

Meantime slowly rotate the DISC control clockwise away from ALL METAL until the unit does not sound or sounds short tone. You can identify what kind of metal is detected according to the setting position of DISC.

A reference for you to know what kind of metal is rejected depending on the DISC setting.

Setting of DISC	Metal Rejected
Near 11:00	Iron
Near 12:00	Nickel coin(5¢), pull tab
Near 13:00	Zinc coin(1¢ 87 version)
Near 15:00	Copper coin (1¢ 76 version)

When the DISC control is set to the clockwise end most of metal is rejected, except silver (25¢, 50¢ and \$1).

SEARCH COIL SWEEPING HINTS

- Never sweep the search coil as if it were a pendulum. Raising the search coil while sweeping or at the end of a sweep will cause false readings.
- Sweep slowly hurrying will cause you to miss targets.
- It's better you sweep the search coil from side to side in an arc line of 3 inches motion and keep the search coil parallel with the ground.

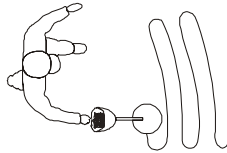

FACTORS THAT AFFECT DETECTING

It's difficult to have an accurate detecting result. It takes practice to get better detection results. Sometimes the detecting may be restricted by some factors.

- If there are interference from other instruments or electrical cable, TV or radio in your searching area, lower the sensitivity, or to change the current searching area.
- When searching in highly mineralized area, the unit will sound even if there's no metal. In this case, you can lower the sensitivity and increase the height between the search coil and the ground until the false signal disappears. If necessary, reset the DISC.
- When searching in trash area, it's better to set the DISC to 11:00 position, so that the unit can notch most of invaluable metals such as nails and small trashy iron.
- Move away any metal digging tool when searching.
- Sensitivity level is generally in contradiction with that of the Discrimination. The higher the sensitivity level is, the worse discrimination will be. But you can lower the sensitivity to have better discrimination.

CARE AND MAINTENANCE

Your metal detector is an example of superior design and craftsmanship. The following suggestions will help you care for your metal detector so you can enjoy it for years.

Handle the detector gently and carefully. Dropping it can damage circuit boards and can cause the detector to work improperly.

Use the detector only in normal temperature environments. Temperature extremes can shorten the life of electronic devices, causing internal damage to the detector.

Keep the detector away from dust and dirt, which can cause premature wear and tear of parts.

Wipe the detector with a damp cloth occasionally to keep it looking new. Do not use harsh chemicals, cleaning solvents, or strong detergents to clean the detector.