



Owner's Manual

Remote Controlled Dog Training Collars
dogtra Element 300M Series



Dogtra Company
22912 Lockness Avenue
Torrance, CA 90501 U.S.A.
Tel) 310.534.0101
Fax) 310.534.9111
Toll free) 1.888.811.9111
Store website) shop.dogtra.com

Copyright © 2009 Dogtra Company All rights reserved. (5)



www.dogtra.com

• MAIN FEATURES	2
• PRODUCT SAFETY AND HEALTH STATEMENTS	3
• PACKAGE CONTENTS	4
• DESCRIPTION OF TRANSMITTER PARTS	5
• BUTTON FUNCTIONS	11
• DESCRIPTION OF COLLAR / RECEIVER PARTS	15
• BATTERY CHARGER	19
• TESTING YOUR dogtra Element 300M Series COLLAR	20
• FITTING THE COLLAR ON THE DOG	22
• CHARGING THE BATTERIES	24
• RECEPTION	26
• ACCESSORIES	27
• BASIC MAINTENANCE	28
• TROUBLE SHOOTING GUIDE	29
• WARRANTY AND REPAIR INFORMATION	32
• EC DECLARATION OF CONFORMITY	37

MAIN FEATURES

- Easy-to-use, ergonomic transmitter.
- Rheostat dial that allows for gradual increases in stimulation intensity with no jumps between levels.
- The Dogtra Element 300M Series has a 1/2-mile range.
- Two-dog model allows the trainer to control two different dogs from one transmitter.
- Waterproof collar/receiver and handheld transmitter.
- Reduced receiver/collar is ideal for small/medium size dogs.
- No external antenna on the collar receiver.
- Rechargeable, user-replaceable Ni-MH batteries.
- One-charger system allows the transmitter and receiver(s) to be charged at the same time.
- Over 8000 different identity codes to prevent conflicts with other e-collars.

PRODUCT SAFETY AND HEALTH STATEMENTS

Proper e-collar use

Dogtra e-collars are intended for the sole purpose of behavior modification of dogs. They are not intended for human use or use on other animals. Dogtra Company does not assume any liability for improper use of the dogtra e-collar.

Aggressive dogs

Dogtra does not recommend using the e-collar to correct dogs that are aggressive towards other dogs or people. In many such cases the dog will associate the stimulation with the other dog or individual and become even more aggressive. Dog aggression is best treated by a dog-training specialist.

Interference with other electronic devices

Dogtra's industry-leading technology filtering system ensures minimal interference with other electronic devices (garage door openers, pacemakers, etc.). Our digital microprocessor offers thousands of unique codes to eliminate frequency match-up with other dogtra e-collars.

Inadvertent activation

If the constant button is held down for 12 seconds or more the unit will automatically shut down. It reactivates when the button is released.

PACKAGE CONTENTS

- Transmitter
- Receiver (two collar/receivers for dogtra two-dog models)
- Battery charger and splitter cable
- Owner's manual

DESCRIPTION OF TRANSMITTER PARTS

dogtra Element 300M transmitter (1-dog unit)

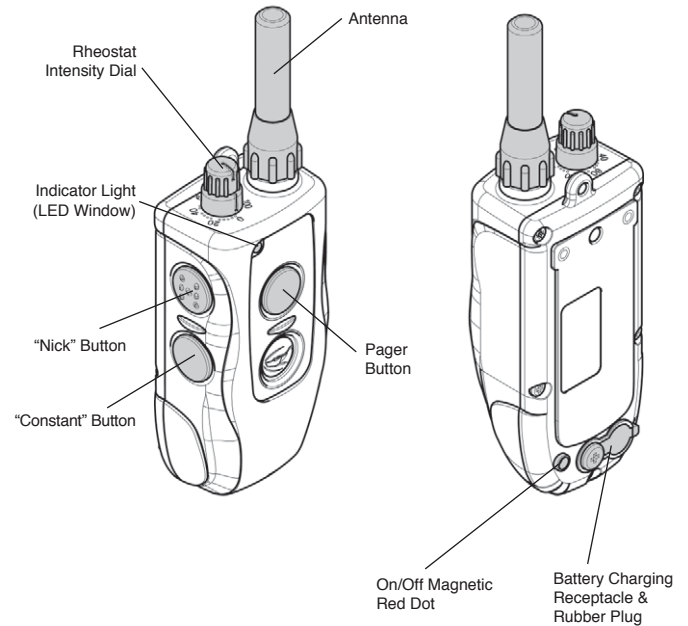

DESCRIPTION OF TRANSMITTER PARTS

dogtra Element 302M transmitter (2-dog unit)

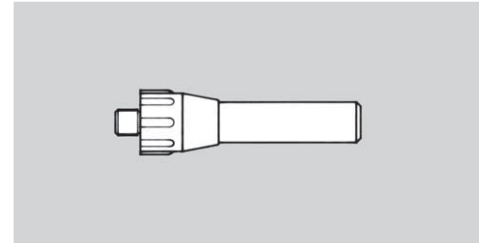
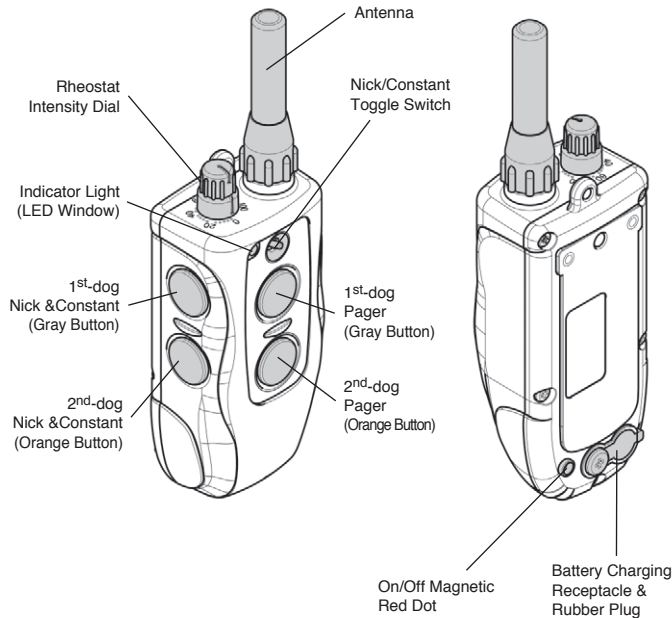

Transmitter Antenna

A short 2" antenna is supplied with the *dogtra* Element 300M Series transmitter.

The antenna must be fastened to the transmitter before using the unit.

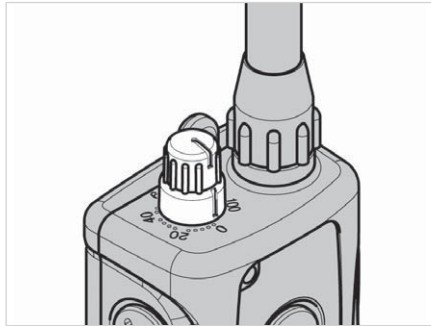

Rheostat Intensity Dial

The Rheostat Intensity Dial is located on the top of the transmitter: (0) being the lowest level and (100) being the highest level.

You will need to adjust the setting (upward or downward) depending on your dog's temperament and threshold for stimulation. Also, as the dog's attitude changes, especially during times of increased excitement or distraction, you may need to adjust the intensity level.

NOTE : In the constant mode, the stimulation intensity can be increased or decreased while the button is depressed.

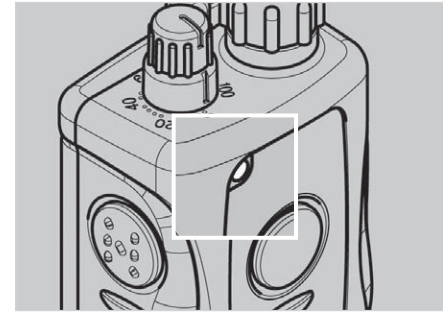

Transmitter Indicator Light (LED Window)

The transmitter indicator light (LED) is located near the Rheostat Intensity Dial. The LED light will come on when a button is pressed.

The color of the light indicates the status of battery life. Green Indicates the battery is fully charged. It turns to amber when the battery is at medium charge. It is acceptable to charge your unit even at medium charge without any damage incurred to your unit. When the transmitter indicator emits a blinking red light, the battery needs to be recharged.

(**Green** = full charge, **Amber** = medium charge, **Red** = needs charge).

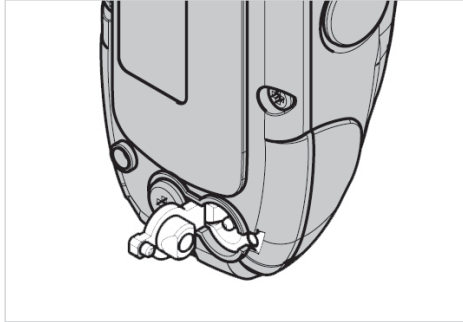

Transmitter Battery Charging Receptacle & Rubber Plug

Located on the backside of the transmitter, the charging receptacle is covered by a rubber plug. Insert one end of the battery charging cable into the receptacle to charge the battery (See Battery Charging Procedure on page 25).

After charging is completed, close the receptacle with its rubber plug to make sure dirt or water does not get inside.

BUTTON FUNCTIONS

dogtra Element 300M (1-dog unit)

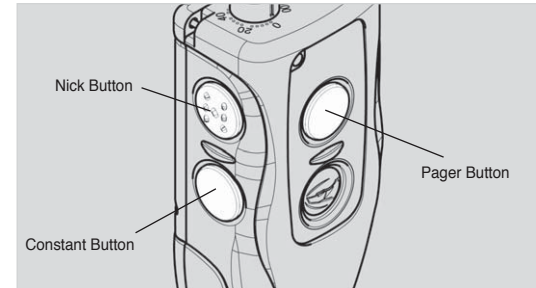

The transmitter for the *dogtra* Element 300M single dog unit has three buttons (one on the face of the transmitter, two on the left side).

“Nick” Button

The “Nick” button is located on the top left. It is imprinted with the letter “N” for an easy, clear selection. When the “Nick” button is pushed the receiver emits a single rapid pulse of electrical stimulation.

“Constant” Button

The “Constant” button is located on the bottom left. Pressing the “Constant” button gives continuous stimulation as long as the button is pushed, for up to 12 seconds. If the button is not released after 12 seconds, the stimulation will automatically turn off as a safety feature. The collar will be ready to be reactivated once the button has been released.

“Pager” Button

The “Pager” button is located on the face of the transmitter. Pressing it will give a non-stimulating vibration as long as the button is depressed, for up to 12 seconds.

***dogtra* Element 302M (2-dog unit)**

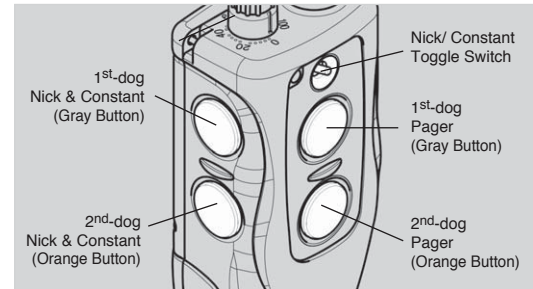

The *dogtra* Element 302M two-dog unit has four buttons and a toggle switch on the transmitter. (Two on the face of the transmitter, two on the left side)

“Nick” & “Constant” Toggle Switch

Located on the face of the transmitter is a toggle switch. The toggle switch has a setting for “Nick” and another for “Constant”. The color-coordinated buttons (orange for the orange receiver/collar and gray for the black receiver/collar) will implement the desired stimulation based on the toggle switch setting.

When either the orange or gray stimulation button is pressed and the toggle is set on “Nick”, the receiver emits a single rapid pulse of electrical stimulation.

When you press either the orange or gray stimulation button and the toggle is set on “Constant”, the receiver emits a continuous stimulation as long as the button is pushed, for up to 12 seconds to the corresponding collar. If the button is not released after 12 seconds, the stimulation will automatically turn off as a safety feature. The collar will be ready to be reactivated once the button has been released.

“Pager” Button

The “Pager” buttons are located on the face of the transmitter. The orange button corresponds with the orange receiver/collar and the gray with the black receiver/collar. Pressing it will give non-stimulating vibration as long as the button is depressed, for up to 12 seconds.

DESCRIPTION OF COLLAR / RECEIVER PARTS

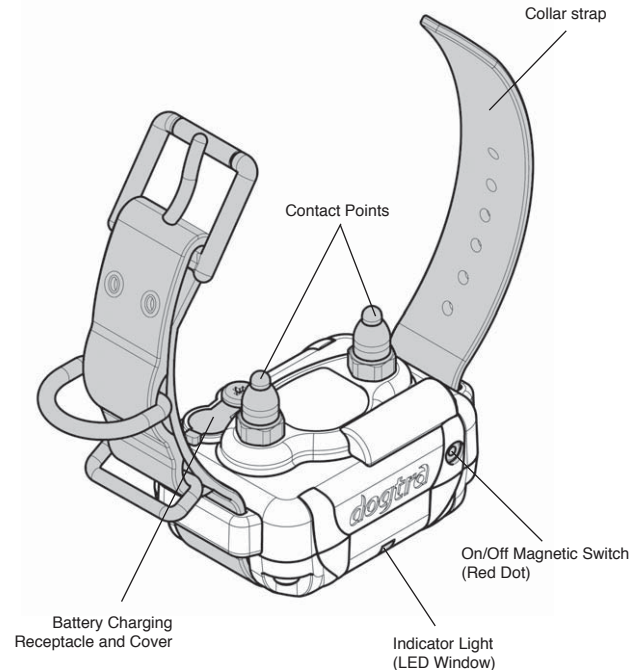

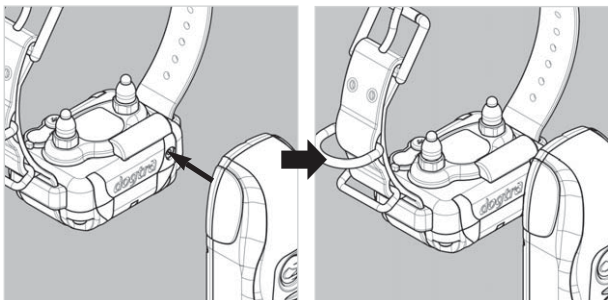

Receiver On/Off Magnetic Switch (Red Dot)

To activate the receiver/collar, place the red dot on the back of the transmitter to the red dot on the collar/receiver. Hold the two red dots together for a moment until the LED light on the receiver/collar comes on.

To deactivate the unit, repeat the same procedure holding the two red dots together momentarily. The LED light will turn red for a brief moment indicating that the collar/receiver is now shut off.

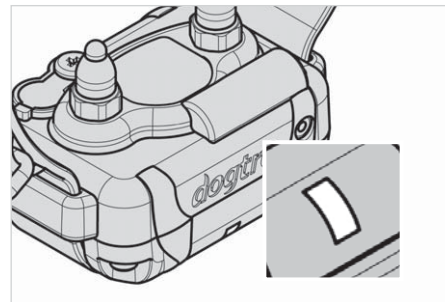

Receiver Indicator Light (LED)

Located on the front of the receiver/collar, the indicator light comes on and blinks once every 4 seconds after the collar has been turned on. The color of the LED indicates the battery life of the receiver.

(**Green** = full charge, **Amber** = medium charge, **Red** = needs charge)

When the “Constant” button on the transmitter is pushed, the collar indicator light will glow steadily (either green, amber, or red based on the remaining battery life), as long as you hold the button down, for up to 12 seconds.

When the “Nick” button is pushed, the light comes on for a fraction of a second.

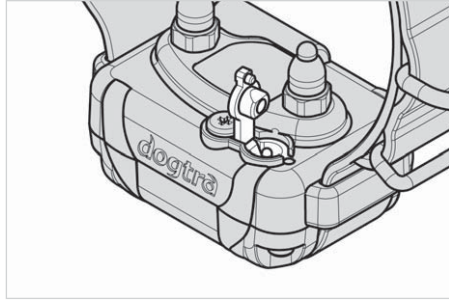

Receiver Battery Charging Receptacle & Rubber Plug

On the inside of the collar receiver, next to the collar strap, is a battery charging receptacle with a rubber plug. (See Battery Charging Procedure on page 25)

If the dog was in salt-water, be sure to rinse the receiver and charging port with clean water.

Internal Antenna

All Dogtra E-collars have non-exposed antennas that are located inside the collar/receiver.

BATTERY CHARGER

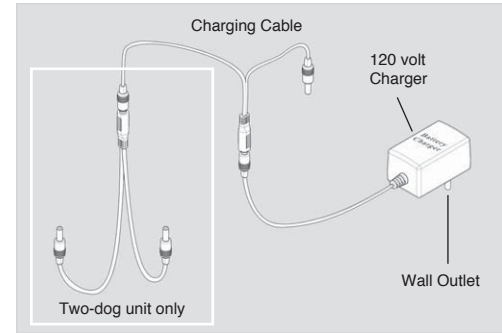

The battery charger and charging cables allow you to charge both the transmitter and receiver at the same time. The battery charger is designed for a 120-volt wall outlet. (European 230-volt AC chargers and 12-volt car chargers are also available.)

To use the battery charger for the two-dog unit, combine both sets of battery charging (splitter) cables as shown. This enables you to charge the transmitter and both receivers at the same time.

TESTING YOUR *dogtra* Element 300M Series COLLARS

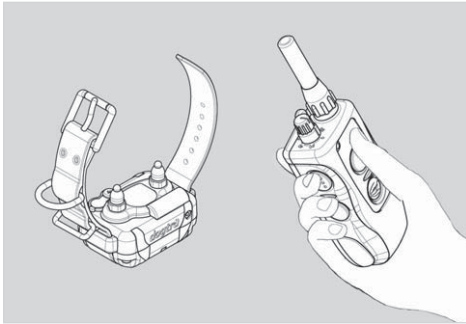

1. To activate your *dogtra* Element 300M Series place the red dot on the back of the transmitter to the red dot on the collar/receiver. Hold the two red dots together for a moment until the green colored LED indicator light comes on. The indicator light will blink every two seconds showing the unit is charged and ready to use. (If the indicator light emits a red color, the batteries need to be charged.)

2. The indicator light(LED) on the collar/receiver will light briefly when the nick button is pressed. Pressing the Constant button will light the indicator for as long as you hold the button down, up to twelve seconds.
3. As a safety feature, the *dogtra* Element 300M Series will automatically shut off stimulation if the Constant button is depressed for twelve seconds or longer. The unit will be ready to be reactivated once the button is released.

FITTING THE COLLAR ON THE DOG

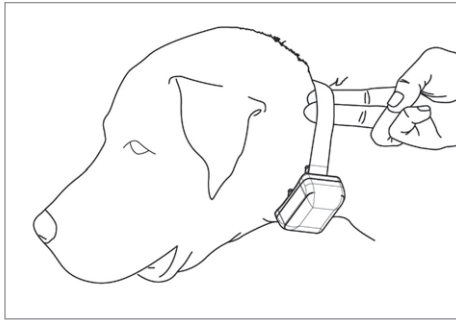

PROPER FIT

The collar should be fitted so that the surgical stainless steel contact points press firmly against the dog's skin. You should be able to fit a finger in between the contact point and your dog's skin. The best location is either side of the dog's windpipe.

IMPROPER FIT

A loose fit can allow the collar to move around on the dog's neck. When this happens, the contact points may rub the skin and cause irritation. If the collar is too loose, electrical contact will be inconsistent and your corrections will be inconsistent also.

Dogtra uses surgical stainless steel contact points and Anti-microbial plastic to protect the dog's skin.

ATTENTION!

Leaving the collar/receiver in the same location on the dog's neck, for an extended period of time can cause skin irritation. If the dog is to wear the e-collar for long periods, occasionally reposition the collar so that the contact points are moved to a different location on the dog's neck. Make sure you check for skin irritation, each time you use the unit.

CHARGING THE BATTERIES

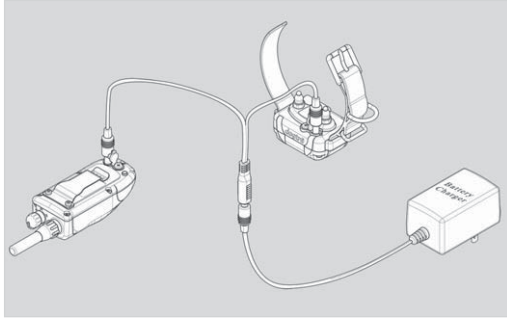

dogtra Element 300M Series uses Ni-MH (Nickel-Metal-Hydride) batteries.

1. **Charge the unit before using the unit for the first time.**
2. Do not charge the batteries near any flammable substances.
3. Fully charge the batteries for 10 hours if the unit is to be stored without use for a period of 3 months or more.

Recharge the unit if :

- The LED indicator light on the collar/receiver is emitting a red color.

- The indicator light on the transmitter or receiver will not **ACTIVATE**.
- The transmitter or receiver does not stay on when one of the stimulation or pager buttons is pushed.

Battery Charging Procedure

1. Attach the charging cables to both the transmitter and receiver(s), as shown on page 24.
2. Plug the charger into a 120-volt wall outlet or, if using the accessory field charger, plug into a cigarette lighter. (Use a 230-volt European charger for Europe.) When properly plugged in, all indicator lights should glow red. The receiver automatically turns off when you insert the charging cable into the battery-charging receptacle on the receiver.
3. After charging, cover the battery charging receptacles with the rubber plugs on the transmitter and receiver.
4. The battery is fully charged with a 10-hour charge. The lights will stay red during the charging process. They **DO NOT** turn green when fully charged. Charging the batteries for more than 10 hours at one time will not extend the battery life.

RECEPTION

The **dogtra** Element 300M Series collar has a range of 1/2-mile. Depending on the way you use your transmitter, the range may vary.

Hold the transmitter away from your body and avoid touching the antenna, to get the greatest range.

For maximum signal strength, keep your unit properly charged.



Maximum Range



Typical Range



Minimum Range

ACCESSORIES

The following items may be purchased separately by calling our customer service at (888) 811-9111. You may also browse the selection at www.dogtra.com.

European Charger

Designed for use with 230V AC electrical outlets in Europe.

Field Auto Charger

Designed for use with the 12-volt cigarette lighter in your car.

Belt Clip

The metal belt clip accessory is for the transmitter.

BASIC MAINTENANCE

Be sure that the rubber charging plugs are always secured when the collar is in use. If your plugs break or are ripped, please contact Customer Service at info@dogtra.com or (888) 811-9111 to obtain replacements.

After each session, carefully inspect your unit for any missing parts or casing damage. Broken casings on either the receiver or transmitter may affect the waterproof guarantee of the unit. The transmitter antenna should be secured and tight for optimum performance. Rinse the unit after each session and clean off any dirt or debris.

Storage Maintenance

Your unit should be fully charged for 10 hours before extended storage. During storage, the unit should be charged every 3 months for 10 hours, and once before the first use.

When traveling, try to store your units in room or slightly warmer temperatures. Do not transport the unit exposed in extreme climates.

Troubleshooting

If you suspect your unit is malfunctioning please refer to the “Troubleshooting Guide” before you send your unit in for service.

If you have any questions or concerns, you may direct your inquiries to info@dogtra.com or call (888) 811-9111.

TROUBLESHOOTING GUIDE

1. My dog is not reacting to the collar.

- Make sure the receiver is turned on. Place the two red dots together to activate the receiver.
- Be sure the collar strap is tight enough so both contact points are touching the dog’s skin.
- The contact points may be too short for your dog’s thick or long coat. To place an order for longer contact points, please call (888) 811-9111. If you are already using longer contact points, you might need to trim down the hair on the dog’s neck, so both contact points are touching the skin.
- The intensity level may be too low for your dog. Keep increasing the stimulation until the dog responds usually by neck movement, head shaking, looking over his shoulder, etc. (response may be very subtle so pay attention.)

2. The LED indicator light comes on, but I do not feel any stimulation.

- Your tolerance may be higher than your dog's. You may need to try the unit on your fingertips where sensitivity is higher and/or increase the stimulation level. Be sure both contact points are touching both of your fingertips.
- The battery may be low, check the LED light for battery life.
- If you have a full charge, and you have done all of the above, your unit may need to be serviced. Please contact Customer Service at info@dogtra.com or (888) 811-9111.

3. The transmitter has no range, or stimulation is less when the dog is farther away.

- The antenna(s) may be damaged. To order parts, please contact Customer Service at (888) 811-9111.
- The range indicated on the unit's box is for flat terrain(line of sight). Heavy brush, trees, hills or moisture will affect the range of your unit. For best range, hold the transmitter vertically above your head, and/or try moving to higher ground.
- Any electrical conductors will affect the range, such as cars, chain-link dog runs, metal buildings, and radio towers. For best results, operate away from these structures.

4. My unit is are not holding a charge.

- The batteries might not be charged properly, or the charger, splitter and the charging port needs to be inspected. If you suspect your charger/splitter is not functioning properly please contact Customer Service at info@dogtra.com or (888) 811-9111.
- The charging pin may be damaged. Inside the charging port, there is a metal pin that should be standing straight up and stiff. If the pin is wobbling, broken or missing, you will need to send the unit in to the Repair Dept. The charging port must be clean prior to charging, clean the dirt out with a cotton swab and some rubbing alcohol. If the dog is in salt-water, be sure to rinse the receiver and charging port with clean water.
- For Dogtra units over two years old from the purchase date, the batteries may need to be replaced. You can replace them yourself by contacting Dogtra. Damages incurred to the unit due to improper battery installation are not covered under any warranty. Battery replacement is the only time customers should open the unit, any other unauthorized servicing or tampering with the unit voids your limited lifetime warranty. If you are still having problems after replacing the batteries, Dogtra strongly recommends sending the unit in for inspection.

WARRANTY AND REPAIR INFORMATION

2-Year Limited Lifetime Warranty

Dogtra Company provides the original purchaser with a 2-YEAR WARRANTY for the 175NCP, 180NCP, 200NCP Gold Series, 210NCP Series, 280NCP Series, 300M Series, 1400NCP Series, 1500NCP Series, 1600NCP Series, 1700NCP Series, 1800NC Series, 1900NCP Series, 2000T&B Series, 2200NCP Series, 2300NCP Series, 2500T&B Series, 3500NCP Series, and the SureStim Series. The warranty begins from the date of purchase. For the first two years, coverage is for both Parts and Labor on warranty repair services.

Accessories such as chargers, splitter cables, antennas, straps, and batteries are covered for the first year only. After the first two years, the Limited Lifetime Warranty covers Parts only and does not cover Labor Fees and Accessories. All Shipping fees incurred, the cost of Accessories after the first year, and Labor fees associated with out of warranty repair work, are the customer's responsibility. Labor fees will be variable depending on the extent of the work required. The Limited Lifetime Warranty expires 5 years after a model is discontinued from production by Dogtra.

To Qualify for the Dogtra Warranty

All products must be registered and/or a proof of purchase is required to initiate repair work under warranty. To register your Dogtra product, log onto our website at www.dogtra.com, click on the warranty registration link, and fill out the required information. Registration must be completed within 30 days of purchase. If you do not have access to a computer, you can call our toll free number at 1-888-811-9111, and one of our customer service representatives will register the product for you. If you were unable to register your product within 30 days of purchase, we will accept all products for repair with a proof of purchase. We strongly recommend keeping the original receipt. If your product is not registered and a proof of purchase is not available at the time of service, Dogtra will estimate the age of the unit by the serial number. Serial number estimates can differ

from the actual purchase date. A serial number estimate is the only method of determining an approximate date of purchase without product registration or a proof of purchase.

Not Covered Under Warranty

Dogtra DOES NOT offer warranty for products that have been bought secondhand or as a resold product.

Dogtra DOES NOT replace defective units or provide refunds for products purchased from us after 30 days from the date of purchase.

Dogtra DOES NOT cover the cost of shipping outside of the Continental United States.

Issues of replacement and refunds on units purchased less than 30 days from an authorized dealer must be addressed to the dealer directly. If the products purchased from an authorized dealer are after 30 days from the date of purchase, please send the units to Dogtra for service and repair.

Dogtra DOES NOT cover the cost of repairs and replacements due to misuse by the owner or dog, improper maintenance, and/or lost units. Any water damage on the Water Resistant Transmitters of the 175NCP, 180NCP, 200NCP series, 1400NCP Series, 1500NCP Series, and iQ, and the Water Resistant Receivers of the RRS, RRD, and RR Deluxe, will not be covered. All replacement costs for either the transmitter or receiver will be the owner's responsibility.

The warranty is void if the unit has been altered or an unauthorized person has damaged the unit while attempting repair work.

Battery replacement by the customer during the first year of the 2-year Limited Lifetime Warranty is not recommended. If the customer chooses to replace the batteries, any damage to the unit during the change-out by the owner will void the warranty.

The removal of serial numbers from any Dogtra products will void the warranty.

Dogtra reserves the right to retain and discard any parts or accessories that

have been found damaged upon replacement and repair.

Procedure for Repair Work

If the unit is malfunctioning, please refer to the “Trouble Shooting Guide” in the Owner’s Manual and call customer service at 1-888-811-9111, for technical support, before sending it to Dogtra for Service.

The cost of shipping products under warranty back to Dogtra is the customer’s responsibility. Dogtra is not responsible for units damaged or lost in transition to Dogtra. Dogtra is not responsible for loss of training time or inconvenience while the unit is in for repair work. Dogtra does not provide loaner units or any form of compensation during the repair period.

A copy of the sales receipt showing the purchase date may be required before warranty work is initiated.

Please include a brief explanation outlining the problem and include your name, address, city/state/zip code, daytime phone number, evening phone number, and email address. Or you can visit our website at www.dogtra.com for a service request form. If the repair costs are not covered under warranty, we will call you for payment information and authorization. For any questions concerning your Dogtra products, call us toll free at 1-888-811-9111, M-F 8:30AM - 4:00PM, Pacific Standard Time, or email us at repair@dogtra.com for specific repair inquiries.

Send repair units to :

Dogtra Company / Repairs

22912 Lockness Avenue
Torrance, CA 90501
U.S.A.

The diagrams and representations in the manual may differ slightly from the actual product depending on the model type.

Appendix :

EC Declaration of Conformity

We, Dogtra Company declare under our sole responsibility that the product

Model Name : **Element 300M**

to which this declaration relates is in conformity with
R&TTE Directive 1999/5/EC

By application of the following standards

Essential Requirements	Description (Field)	Applied Specification / Standard
Article 3.1(a)	Safety	EN 60950-1:2006
Article 3.1(b)	EMC	EN 301 489-1 V1.8.1 (2008-04), EN 301 489-3 V1.4.1 (2002-08)
Article 3.2	Radio	EN 300 220-1 V2.1.1 (2006-04), EN 300 220-2 V2.1.2 (2007-06)



