

31368

FORD EXPEDITION & LINCOLN NAVIGATOR

9/30/2014

EXCLUDES TWIN TURBO ECO BOOST

GROSS LOAD CAPACITY WHEN USED AS A WEIGHT CARRYING HITCH: 5,000 LBS. TRAILER WEIGHT & 500 LBS. TONGUE WEIGHT.

GROSS LOAD CAPACITY WHEN USED AS A STRAIGHT LINE PULL: 9,000 LBS. MAX. LINE PULL.

\*\*\* DO NOT EXCEED VEHICLE MANUFACTURER'S RECOMMENDED TOWING CAPACITY. \*\*\*

HAVING INSTALLATION QUESTIONS? CALL TECHNICAL SUPPORT AT 1-800-798-0813

Parts List			
ITEM	QTY	PART NUMBER	DESCRIPTION
1	4	1/2-13 x 1 1/2	CARRIAGE BOLT
2	4	HFN 1213	HEX FLANGE NUT
3	2	CM-SP19	.250 x 1.25 x 3.00" SQUARE HOLE SPACER
4	2	CM-SP20	.250 x 1.50 x 4.00" SQUARE HOLE SPACER
5	2	1_2 FISHWIRE	1/2" FISHWIRE

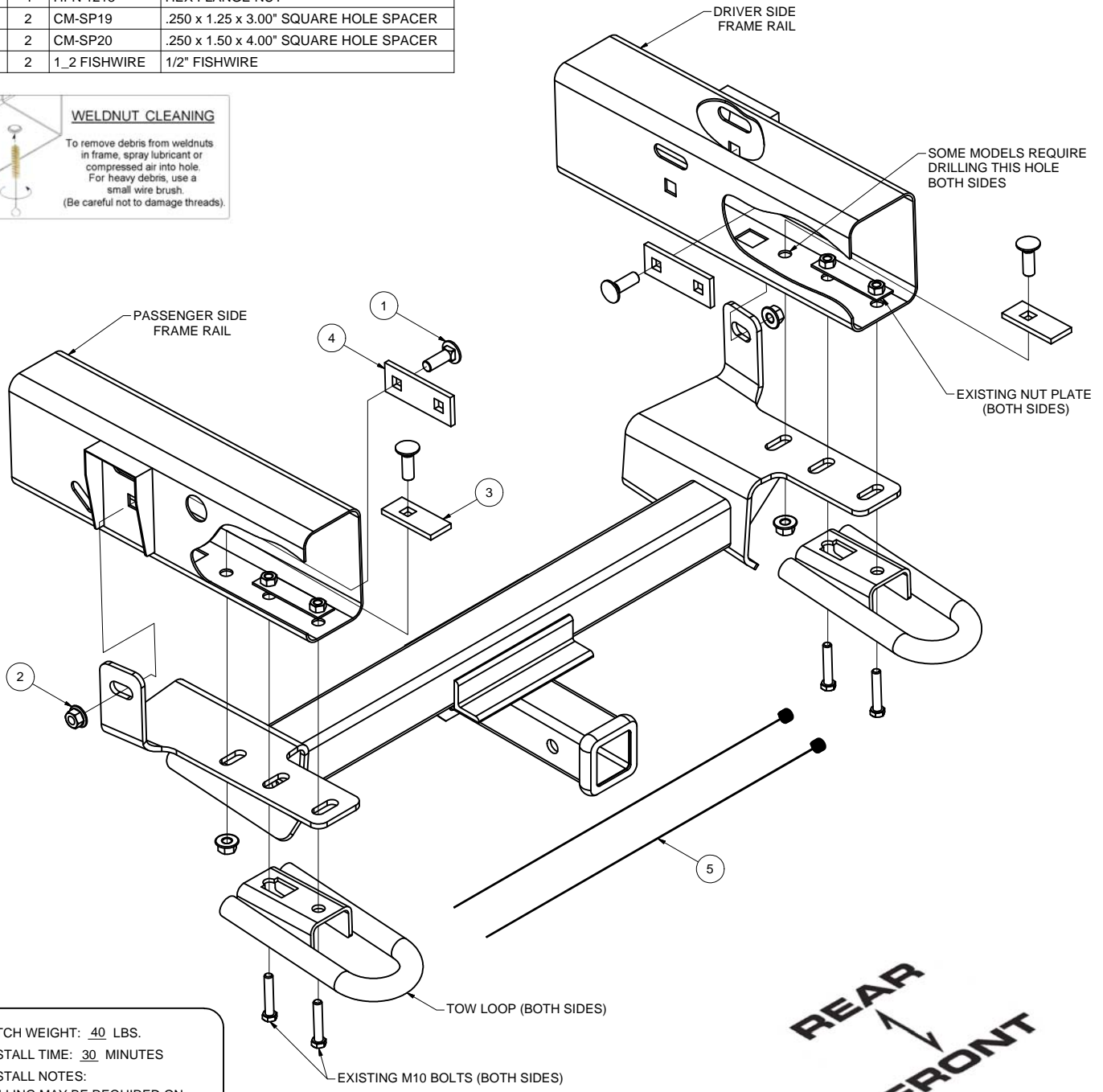
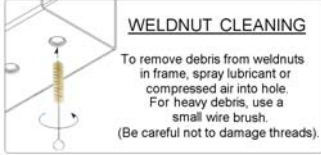

REAR  
FRONT

HITCH WEIGHT: 40 LBS.  
 INSTALL TIME: 30 MINUTES  
 INSTALL NOTES:  
 -DRILLING MAY BE REQUIRED ON SOME MODELS  
 -REMOVE TOW LOOPS  
 -FASCIA TRIMMING MAY BE REQUIRED  
 -FISHWIRE HARDWARE

PERIODICALLY CHECK THIS RECEIVER HITCH TO ENSURE THAT ALL FASTENERS ARE TIGHT AND THAT ALL STRUCTURAL COMPONENTS ARE SOUND.

Curt Manufacturing Inc., warrants this product to be free of defects in material and/or workmanship at the time of retail purchase by the original purchaser. If the product is found to be defective, Curt Manufacturing Inc., may repair or replace the product, at their option, when the product is returned, prepaid, with proof of purchase. Alteration to, misuse of, or improper installation of this product voids the warranty. Curt Manufacturing Inc.'s liability is limited to repair or replacement of products found to be defective, and specifically excludes liability for incidental or consequential loss or damage.

**31368****FORD EXPEDITION & LINCOLN NAVIGATOR****9/30/2014****GROSS LOAD CAPACITY WHEN USED AS A WEIGHT CARRYING HITCH: 5,000 LBS. TRAILER WEIGHT & 500 LBS. TONGUE WEIGHT.****GROSS LOAD CAPACITY WHEN USED AS A STRAIGHT LINE PULL: 9,000 LBS. MAX. LINE PULL.****\*\*\* DO NOT EXCEED VEHICLE MANUFACTURER'S RECOMMENDED TOWING CAPACITY. \*\*\*****HAVING INSTALLATION QUESTIONS? CALL TECHNICAL SUPPORT AT 1-800-798-0813****FISHWIRE TECHNIQUE**

INSERT COILED END OF FISHWIRE TOOL THROUGH HITCH MOUNTING HOLE IN VEHICLE FRAME RAIL AND OUT THE ACCESS HOLE. PASS COILED END OF FISHWIRE THROUGH SPACER AND THREAD BOLT INTO COIL. KINK WIRE TO KEEP SPACER SEPERATE FROM BOLT AS SHOWN. PULL FISHWIRE, SPACER, AND BOLT THROUGH FRAME AND OUT MOUNTING HOLE. USE FISHWIRE TO GUIDE HITCH DURING MOUNTING AND PREVENT LOSS OF BOLT / SPACER INSIDE FRAME RAIL.

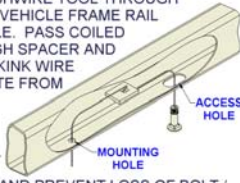

\*\*NOTE: SOME VEHICLES MAY FISHWIRE THROUGH END OF FRAME\*\*

**TOOLS REQUIRED**

SOCKET WRENCH

15mm SOCKET

13mm SOCKET

3/4" SOCKET

4" SOCKET EXTENSION

TORQUE WRENCH

ROTARY TOOL

CUTOFF WHEEL

FLAT HEAD SCREWDRIVER

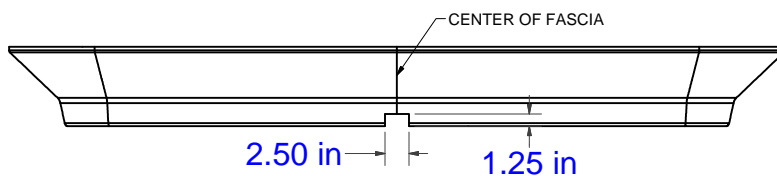
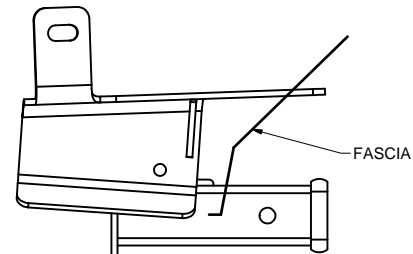
**FASCIA TRIM DIAGRAM  
IF REQUIRED****INSTALLED HITCH POSITION****INSTALLATION STEPS**

1. Remove front M10 bolts from tow loops. Loosen rear M10 bolts and slide tow loops back and off of bolts.
2. Remove rear M10 bolts. Note: Be sure to not allow nut plate to slide too far back into frame rail.
3. If equipped with rear air dam, remove two (2) bolts holding air dam to vehicle frame. Return bolts to vehicle owner. Note: Removing air dam may affect fuel mileage.
4. Slide air dam towards front of vehicle and remove air dam. Return air dam to vehicle owner.
5. Remove weldnut clips from vehicle where air dam was attached. Return weldnut clips to vehicle owner.
6. Using rotary tool and cutoff wheel, trim fascia according to FASCIA TRIM DIAGRAM if required.  
NOTE: (Verify hitch clearance prior to trimming).
7. Raise hitch into position aligning hitch with existing holes in frame.
8. Reinstall tow loops with side plates in between loops and frame rails by using M10 bolts removed in Steps 1 and 2.
9. Fishwire 1/2-13 carriage bolts and CM-SP4 spacers through front of frame and out rear holes in bottom of frame rails as shown on Page 1. (Some models require drilling, use hitch as template.)
10. Fishwire 1/2-13 carriage bolts and CM-SP20 spacers through front of frame and out square holes in side of frame rails as shown on Page 1.
11. Install 1/2-13 hex flange nuts onto carriage bolts.
12. Torque M10 hardware to 48 lb-ft and 1/2" hardware to 110 lb-ft.

PERIODICALLY CHECK THIS RECEIVER HITCH TO ENSURE THAT ALL FASTENERS ARE TIGHT AND THAT ALL STRUCTURAL COMPONENTS ARE SOUND.

Curt Manufacturing Inc., warrants this product to be free of defects in material and/or workmanship at the time of retail purchase by the original purchaser. If the product is found to be defective, Curt Manufacturing Inc., may repair or replace the product, at their option, when the product is returned, prepaid, with proof of purchase. Alteration to, misuse of, or improper installation of this product voids the warranty. Curt Manufacturing Inc.'s liability is limited to repair or replacement of products found to be defective, and specifically excludes liability for incidental or consequential loss or damage.

\*\*\*DO NOT EXCEED VEHICLE MANUFACTURER'S RECOMMENDED TOWING CAPACITY \*\*\*.

#### FRONT MOUNTED ACCESSORIES

1) Do not exceed front axle Gross Weight Rating (GAWR). Consult owners manual or specification plate located on driver's door frame. Measure gross front axle weight by placing front wheels of loaded vehicle on a scale.

**WARNING:** Exceeding GAWR may overload the front axle and/or suspension. This could result in **accident, property damage and personal injury.**

- 2) Reposition front mounted license plate if obstructed.
- 3) Do not obstruct vehicle lights.
- 4) Allow free air flow into grille opening.
- 5) Rear wheel traction may be reduced. This could effect handling. Reduce speed and drive with caution.
- 6) Accessories extend front of vehicle. This may reduce approach angle. Use caution when parking and maneuvering.
- 7) Do not obstruct driver view.

#### VEHICLE RECOVERY AND WINCHING TIPS

1) Use OEM tow hooks, recovery eyes or a clevis mount for attachment of a tow strap or winch cable.

**WARNING: NEVER** use a ball and/or ball mount as an anchor point for tow strap or winch cable. Severe personal injury or death could result.

- 2) Observe winch manufacturer's recommendations, cautions and warnings.
- 3) Attach return cable to tow hook or recovery eye when using a snatch block (See figure 1).

**CAUTION:** Do not attach return cable to winch mount. This may overload winch mount and/or front mounted receiver.

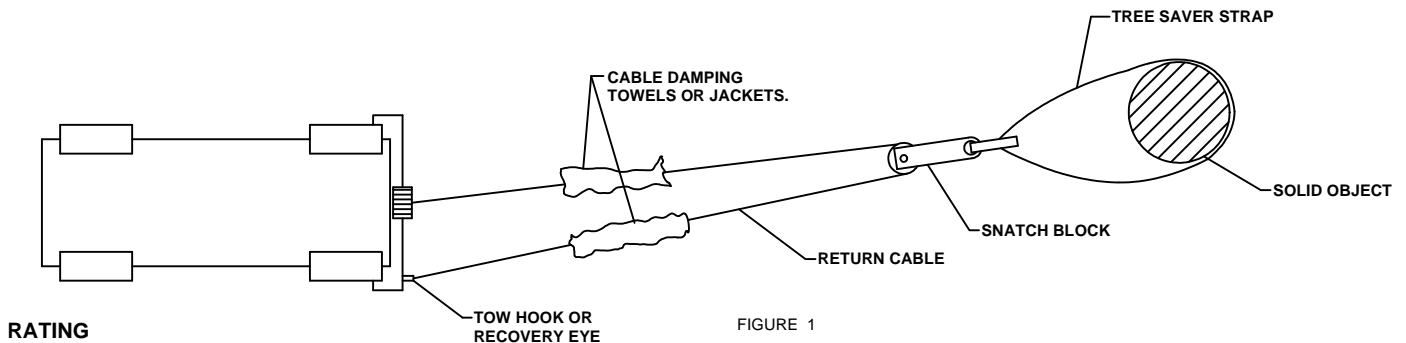

#### RATING

For **Maximum** line pull rating, winch cable must not exceed:

- 15 degree angle up or down from horizontal (See Figure 2).
- 45 degree angle left or right from straight ahead (See Figure 3).

**CAUTION:** Exceeding the maximum line pull rating may over load winch, winch mount, and/or front mounted receiver.

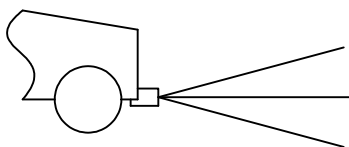

FIGURE 2

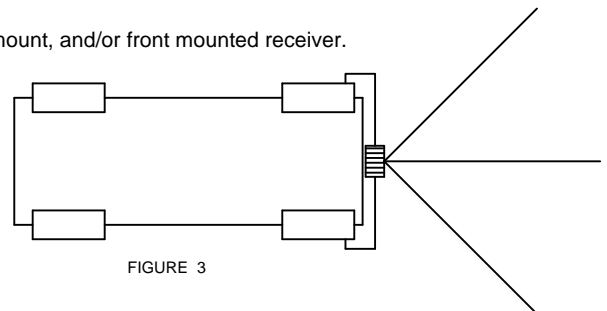

FIGURE 3