

DESIGN PAW FREESTANDING GATE

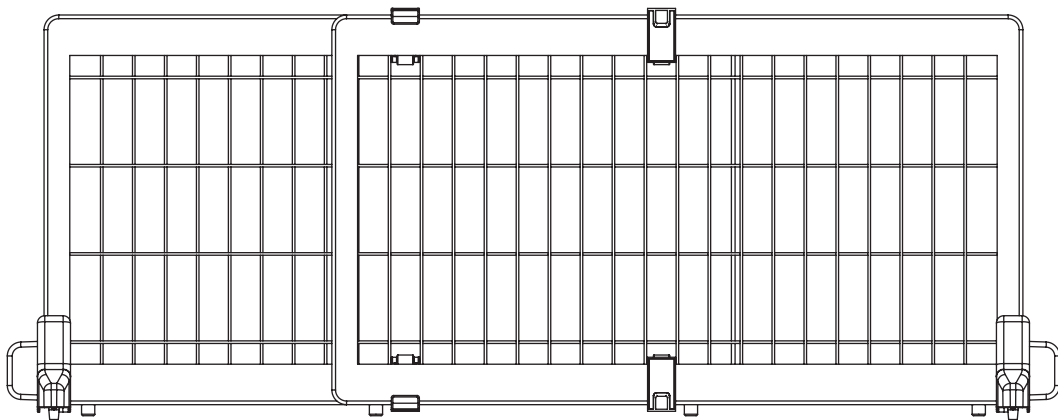

- READ ALL INSTRUCTIONS BEFORE ASSEMBLY AND USE OF GATE.
- KEEP INSTRUCTIONS FOR FUTURE USE.

 www.carlsonpetproducts.com

 Carlson Pet Products, Inc.
3200 Corporate Center Drive, Suite 105 | Burnsville, MN 55306, USA

 952.435.1084

Made in China

Before Using Product

Read and follow all instructions carefully to ensure that your gate is properly installed. Please keep these instructions for your reference.



WARNING

- To prevent serious injury or death, securely install gate or enclosure and use according to manufacturer's instructions.
- Check the gate regularly to see if all the hardware is tightened.
- This is a Pet Gate. NOT intended for use with children.
- Strangulation hazard: pets can force themselves into very small openings; use this gate with pets whose heads will not fit into openings in the gate, between the gate and floor, or between the gate and wall.
- Never use with pet able to climb over or dislodge/open the gate or enclosure.
- Never leave pet unattended.
- To prevent falls, NEVER use at the top of stairs.
- **MODEL 2070:** This gate is designed to fit openings 41 to 70 inches.
- **MODEL 2870:** This gate is designed to fit openings 41 to 70 inches.

Before Assembly

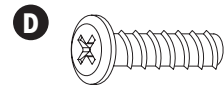
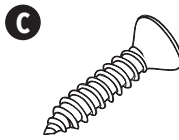
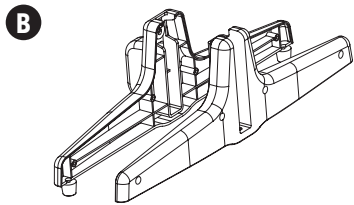
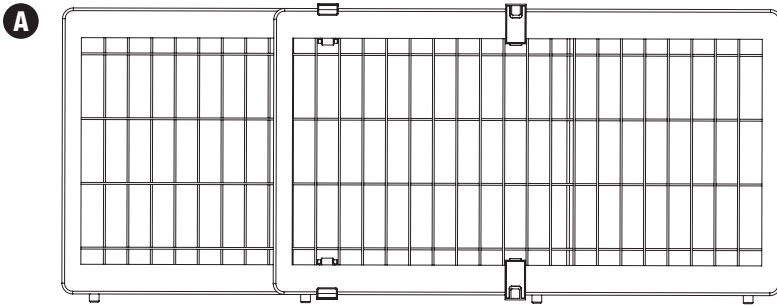

PLEASE CHECK TO MAKE SURE YOU HAVE THE FOLLOWING PARTS:

- A** *Main Gate Panels*
- B** *Stabilizing Leg Assemblies* (2)
- C** *Crosshead Screws* (8) (requires a Phillips/crosshead screwdriver)
- D** *Connector Bolts* (4)

Assembling Your Gate

STEP 1

Connect two halves of one *stabilizing leg*, then secure the leg with (4) *crosshead screws* to secure the leg. Repeat on the other *stabilizing leg*.

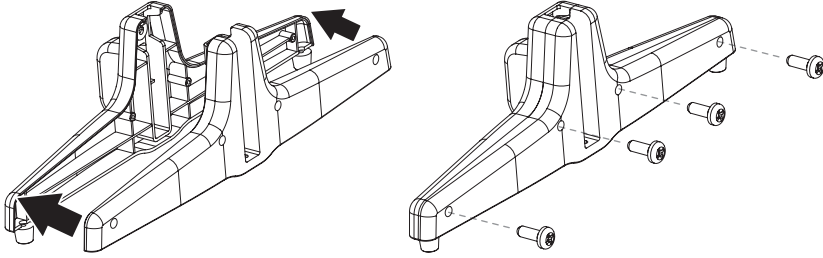

STEP 2

Using the (4) *connector bolts* and a Phillips screwdriver connect the *stabilizing legs* to the ends of the gate.

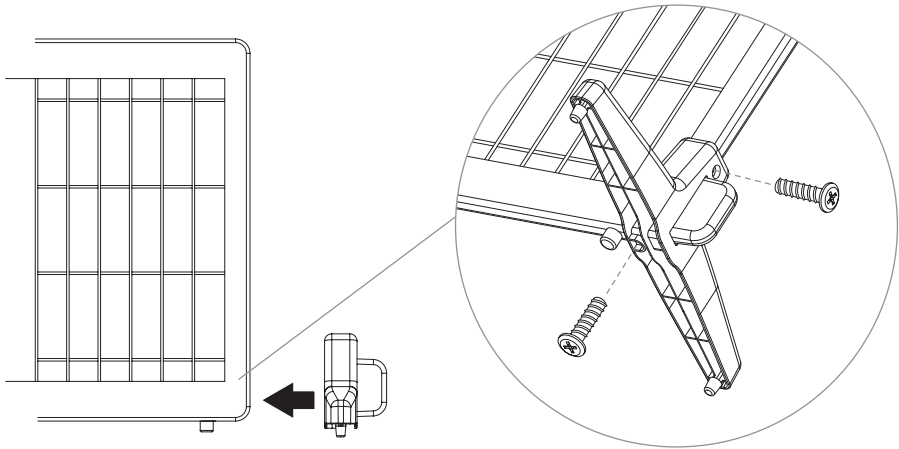

NOTE: The *connector bolts* should be snug, but do not over-tighten them.

STEP 3

Extend the length of your gate to your desired size by unlocking the (4) *locking hinges*. Re-lock the hinges when the gate reaches your desired size.

UNLOCKED

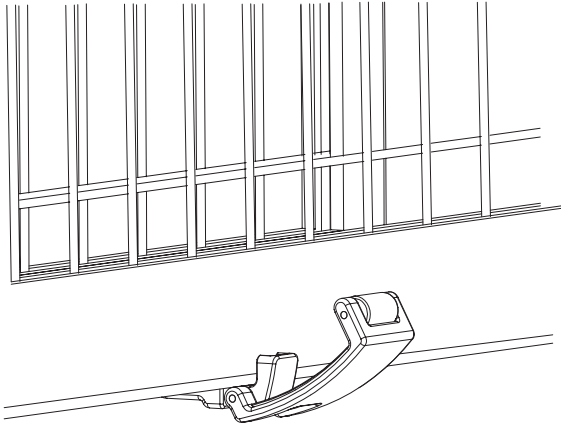

LOCKED

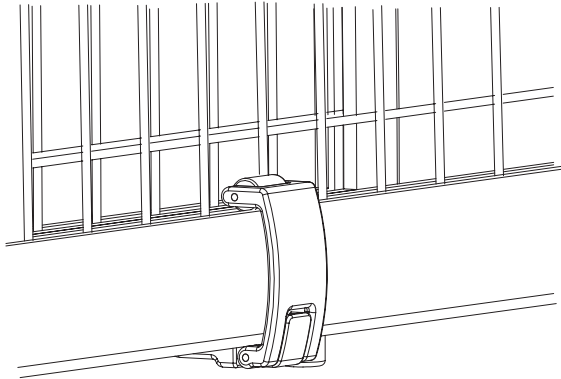

NOTE: The *locking hinges* must be correctly lined up within the gap between the metal fencing. If misaligned, the lock will not fully engage.

The gate may not fit an opening perfectly due to the nature of the locking increments.

Installing Your Gate

STEP 1

Insert gate into the doorway with *tabs* on the same side as your pet will be. This will prevent your pet from pushing the gate out of the doorway.

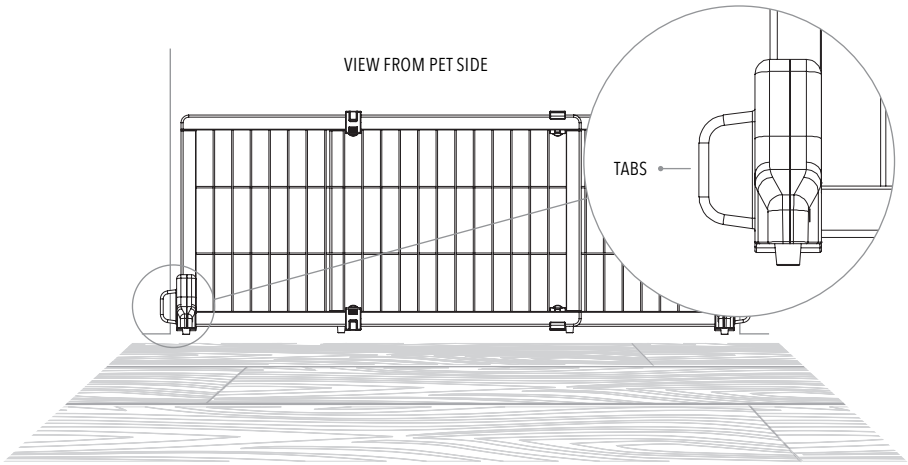

CARE AND MAINTENANCE

Periodically check the gate for signs of damage, wear, or missing components. Do not use if any part is missing, worn or damaged. Check the gate regularly to ensure all the hardware and mountings are tightened. Do not use abrasive cleaners or bleach. Clean by sponging with warm water and a mild detergent.

90 DAYS LIMITED WARRANTY

If, during the first 90 days after consumer purchase of the item, under reasonable and non-commercial use and conditions of maintenance, it fails while owned by the original purchaser because of the quality of materials or workmanship of finish and assembly, Carlson Pet Products, Inc. will replace or repair it at Carlson's option. PROOF OF PURCHASE REQUIRED.

Replacement Parts

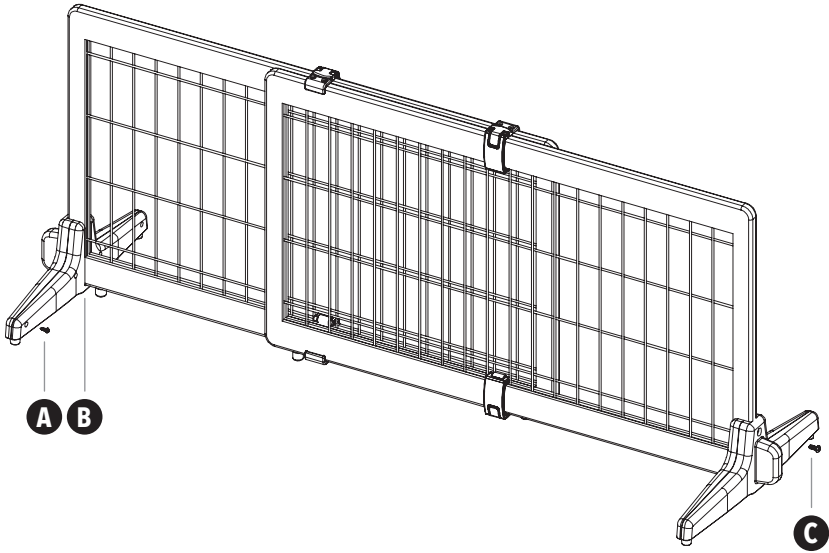

A *Crosshead Screw*
#10054

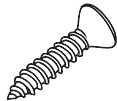

C *Connector Bolt*
#10052

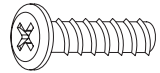

B *Stabilizing Leg Assembly*
Black = #11053

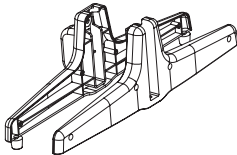



www.carlsonpetproducts.com



Carlson Pet Products, Inc.
3200 Corporate Center Drive, Suite 105
Burnsville, MN 55306, USA



952.435.1084