



SKU: 1168405

DUMOR RED BARN CHICKEN COOP

(66.73in. L x 60.24in. H x 50in. W)



**Distributed by:
TRACTOR SUPPLY COMPANY
5401 VIRGINIA WAY,
BRENTWOOD, TN 37027
For customer support, call: 1-888-376-9601
www.TractorSupply.com
MADE IN CHINA**

CARE INSTRUCTIONS

SAFETY INFORMATION:

⚠ DANGER: Please keep children out of assembly area during assembly.

⚠ WARNING: This product is designed exclusively for chickens .Not intended for children.

BEFORE YOU BEGIN:

Read instruction prior to assembly. This product contains parts that can be damaged if incorrectly assembled. Please follow instructions. For steps where parts are placed upside down, place parts on a smooth surface to avoid scratching finish. Flatten cardboard from carton to create a smooth work surface.

PRE-ASSEMBLY:

TOOLS REQUIRED (not included):

- *Screw Gun with Phillips Head Bit*
- *Adjustable Wrench*





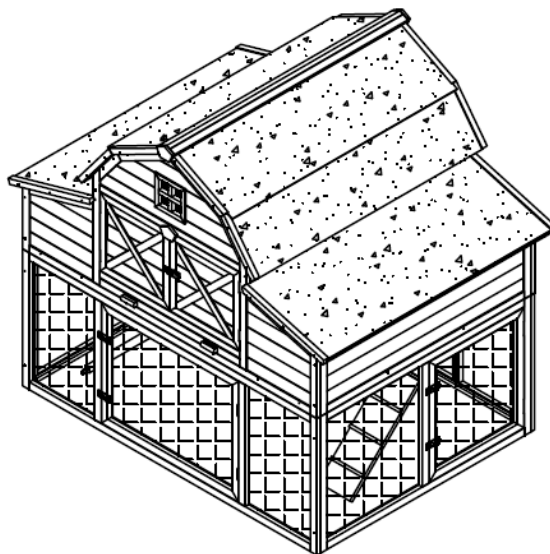

Two people are recommended to assemble this product.



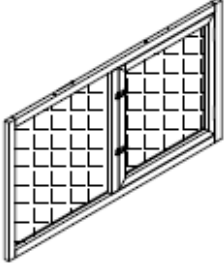
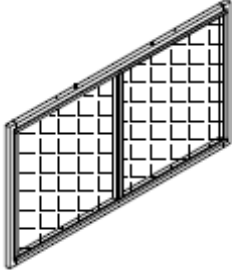
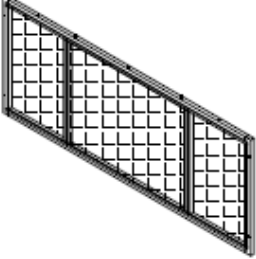
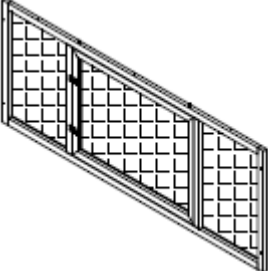
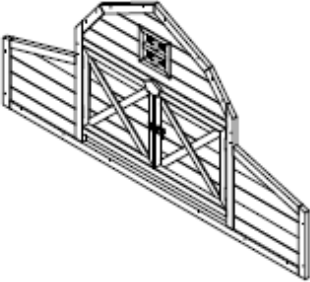
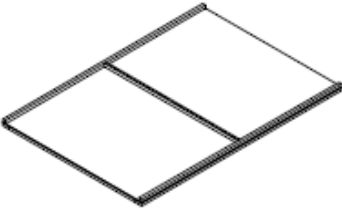

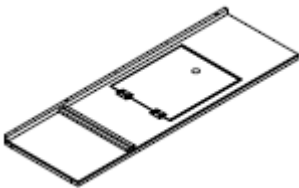
PRODUCT OVERALL VIEW

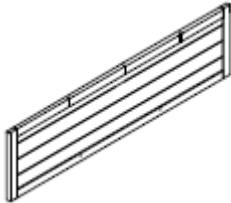
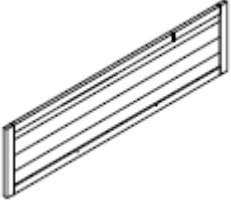

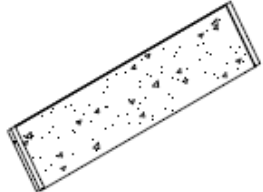

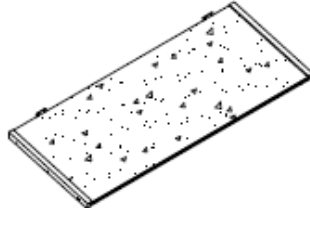

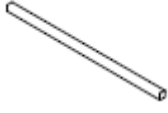

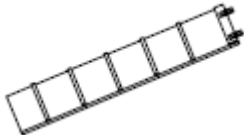

PARTS LIST

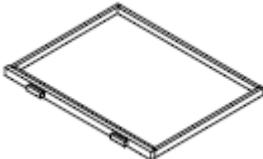
Part	Image	Description	Quantity
1		Right run panel	1 pc
2		Left run panel	1pc
3		Back run panel	1 pc
4		Front run panel	1pc
5		Front & Back Coop panel	2pc
6		Drawer base frame	1 pc

7		Coop bottom panel with ladder door	1pc
8		Nesting box bottom panel	1pc
9		Left side panel of nesting box	1pc
10		Right side panel of coop with ladder door	1pc
11		Upper side panel	2pcs
12		Middle roof panel	2pcs

13		Top roof panel	2pcs
14		Lower roof panel	2pcs
15		Wood post for roosting bar	2pcs
16		Roosting bar	3pcs
17		Roosting bar for run	1pc
18		Nesting box divider	4pcs

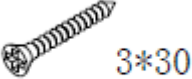
19		Ladder	1pc
20		Roof Cap	1pc
21		Drawer	2pcs
A		Screws 5*60mm	10+1pcs
B		Screws 4*40mm	40+1pcs
C		Screws 4*35mm	22+1pcs

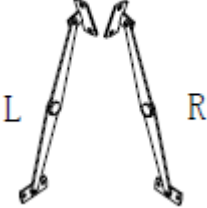
D		Screws 3*30mm	4+1pcs
E		Screws 3*18mm	44+1pcs
F		Latch	2pcs
G		Support arm	4pcs

ASSEMBLY INSTRUCTION

Step 1: Attach front run panel (4) to left run panel (2) using screws (B). Attach right run panel (1) and back run panel (3) with screws (B). After assembling the chicken run, place the roosting bar (18) for run inside the wire.

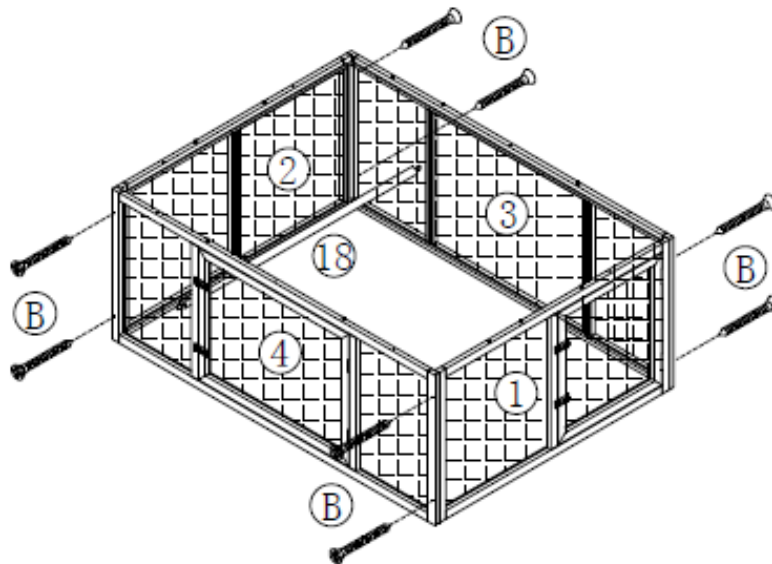

Step 2: Attach the back coop panel (5) to the back run panel (3) using screws (A).

***The screws are installed up through the run panel into the coop panel.

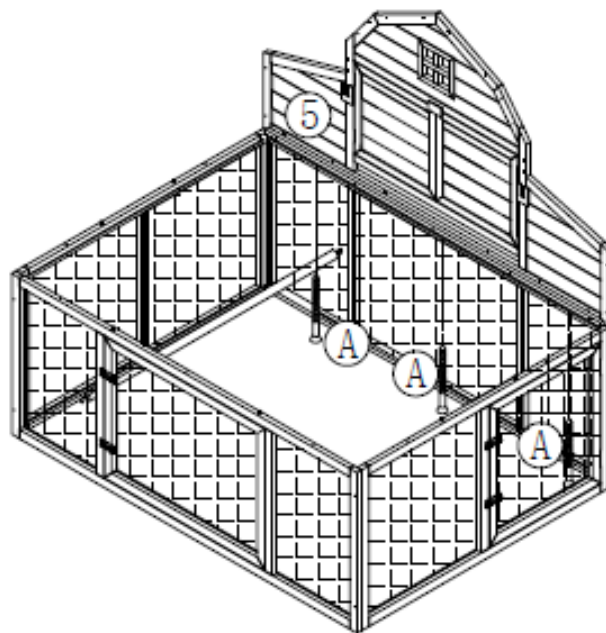

Step 3: Attach the left nesting box panel (9) and the right coop panel (10) to the back coop panel (5) using screws (B).

*** Note that under the right panel (10), the door must be opened to access the screw location. Use screws (A) to attach top coop panels to bottom run panels.

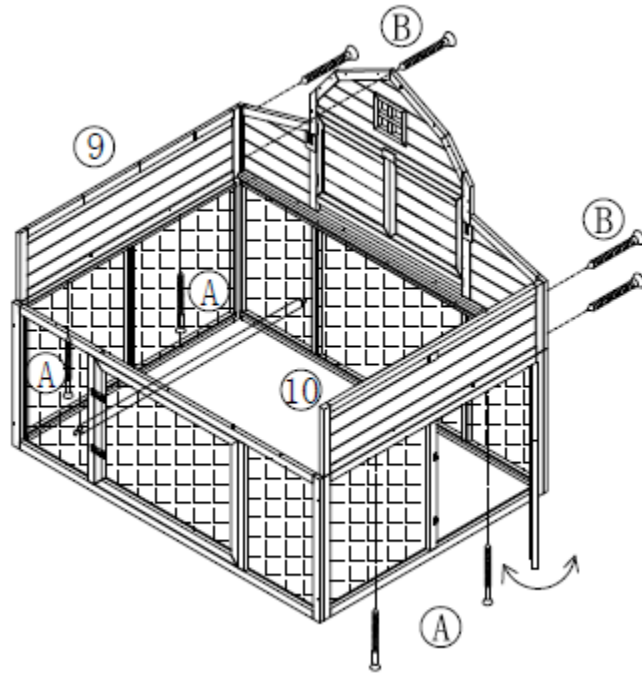

Step 4: Attach the front coop panel (5), as shown, to the side panels using screws (B). Then, using screws (A) connect the front coop panel to run panel.

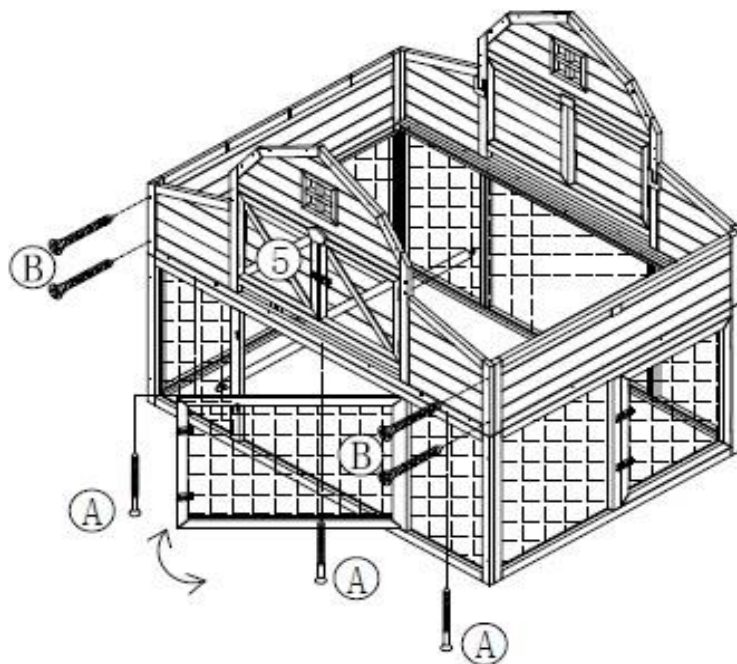

Step 5: Place the drawer base frame (6) in position as shown. Place the coop bottom panel with ladder door (7) on the right side and place the nesting box bottom panel (8) on the left side. Secure all panels with (B) screws.

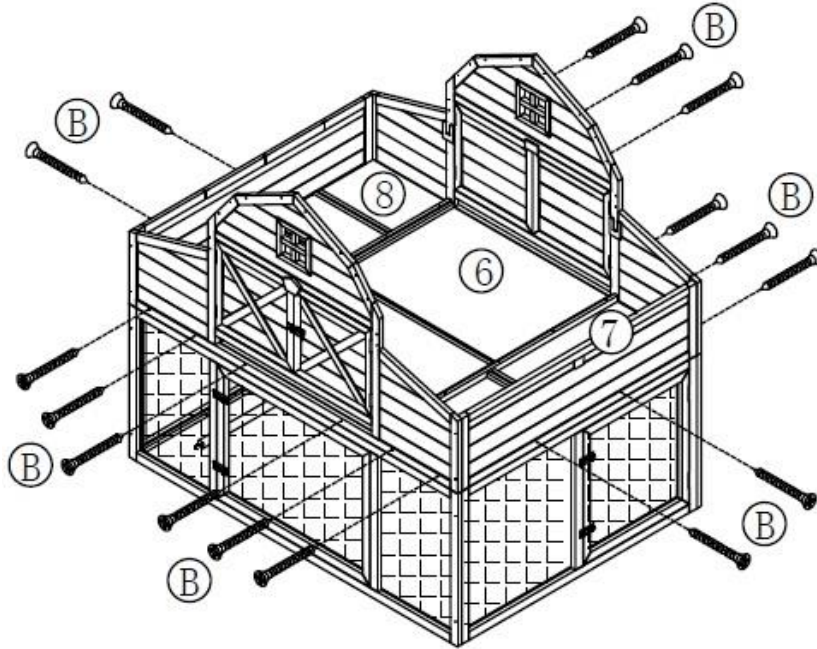

Step 6: Open the ladder door from the bottom panel, attach the ladder (19) using screws (E). Then place the nesting box dividers (18) into the nesting box.

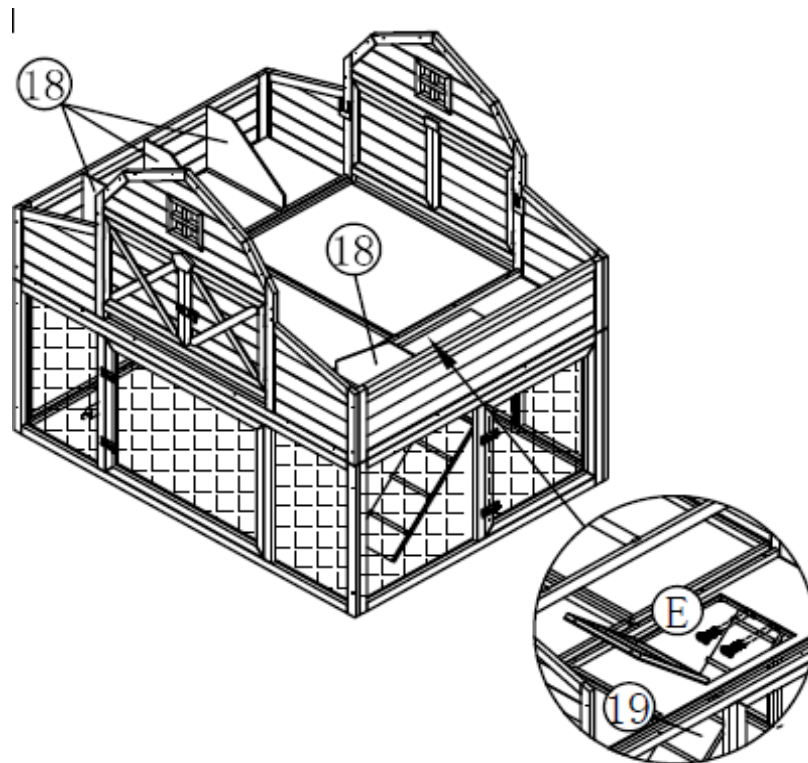

Step 7: Place roosting bar supports (15) into designated holders on front and back coop panels. Place the three roosting bars (16) into support slots and secure with screws (C).

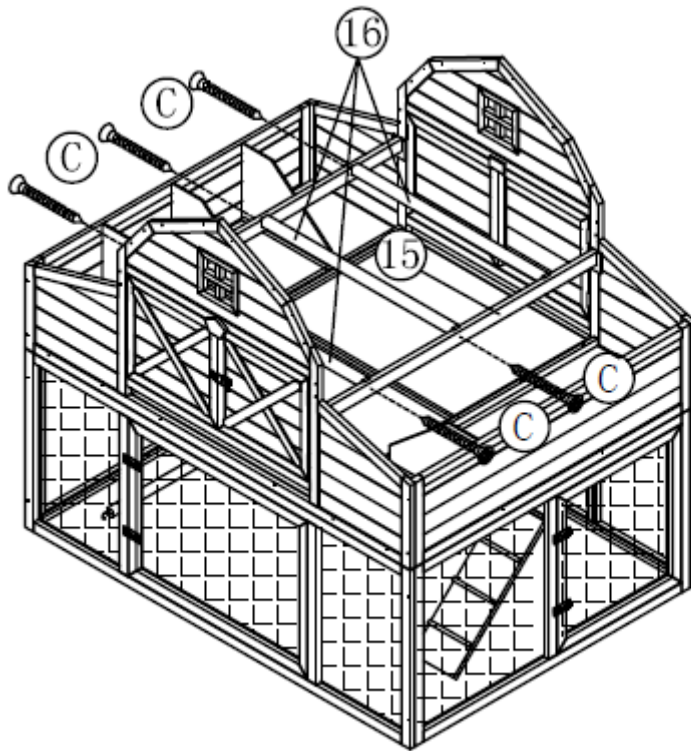

Step 8: Attach the upper side panels (11) to front and back coop panels using screws (B).

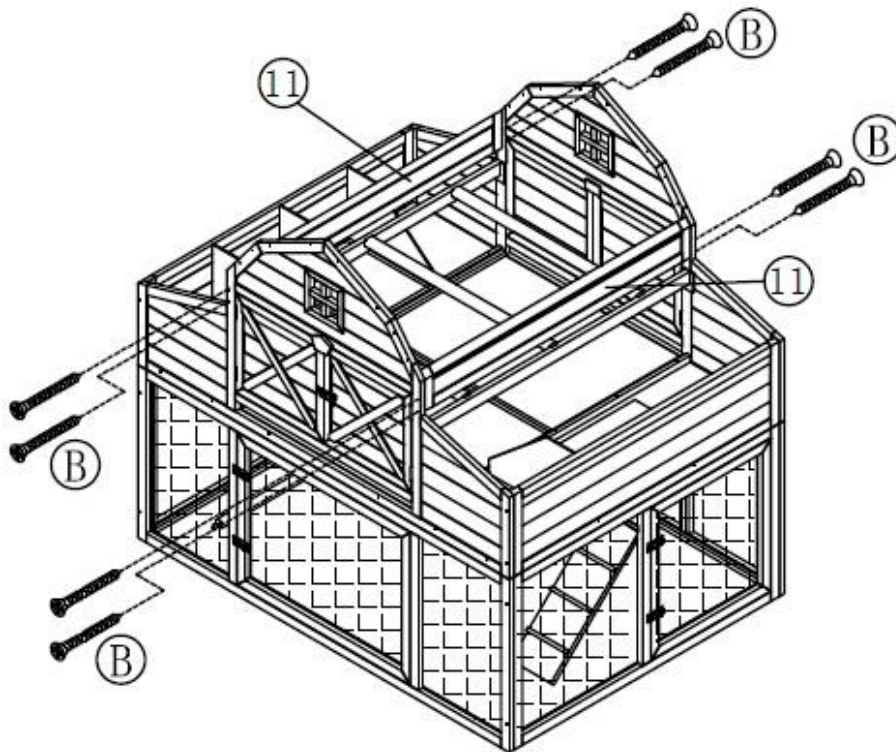

Step 9: Attach the lower roof panels (14) to the upper side panels (11) using screws (E) through hinge plates.

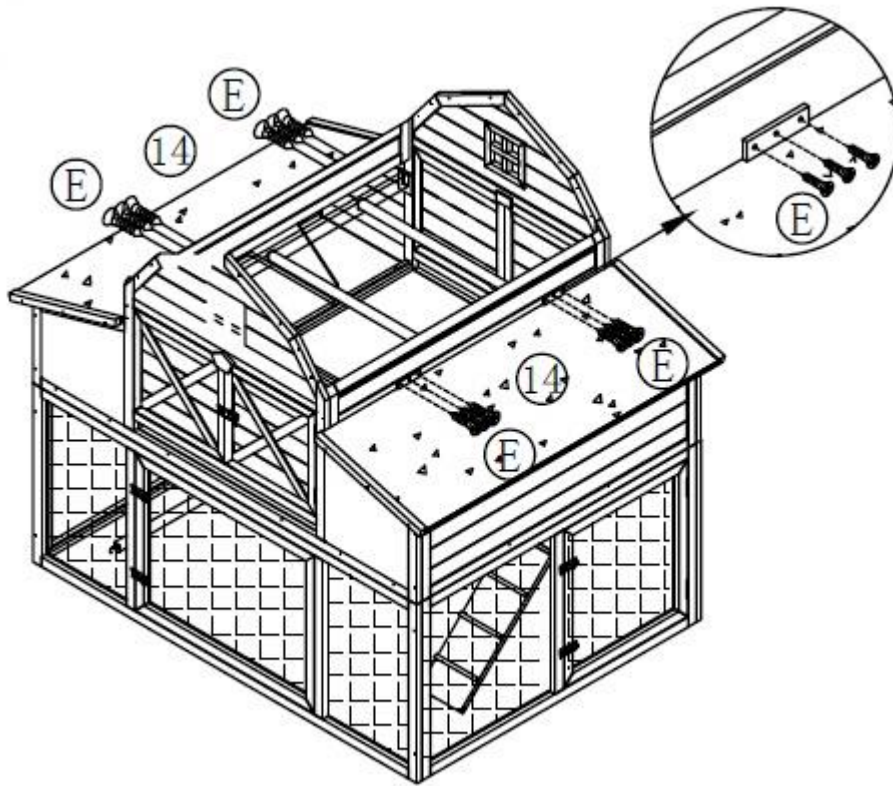

Step 10: Attach the support arms (G) to the lower roof panels (14) using screws (E).

***Note the left and right direction of the support arms.

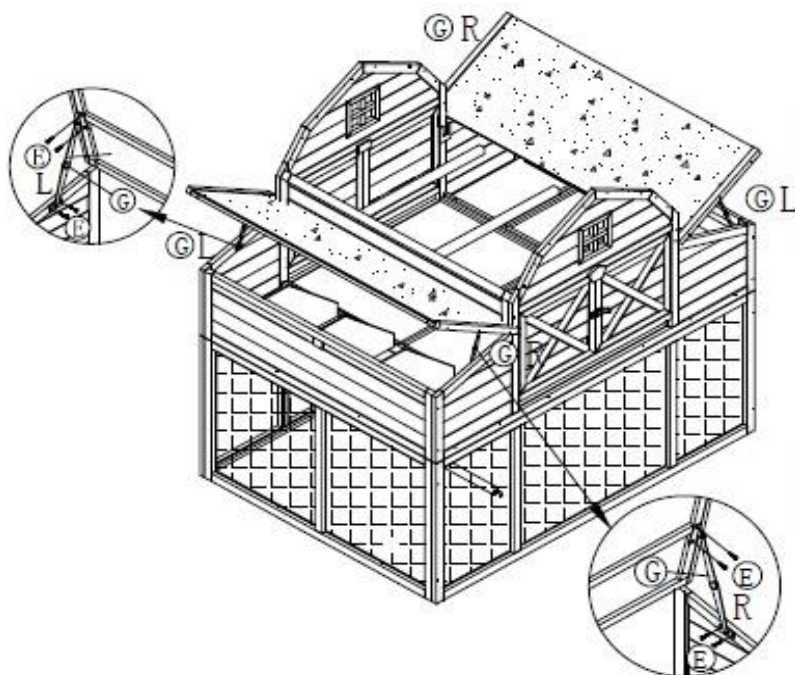

Step 11: Attach the latch (F) to lower roofs and panels using screws (E).

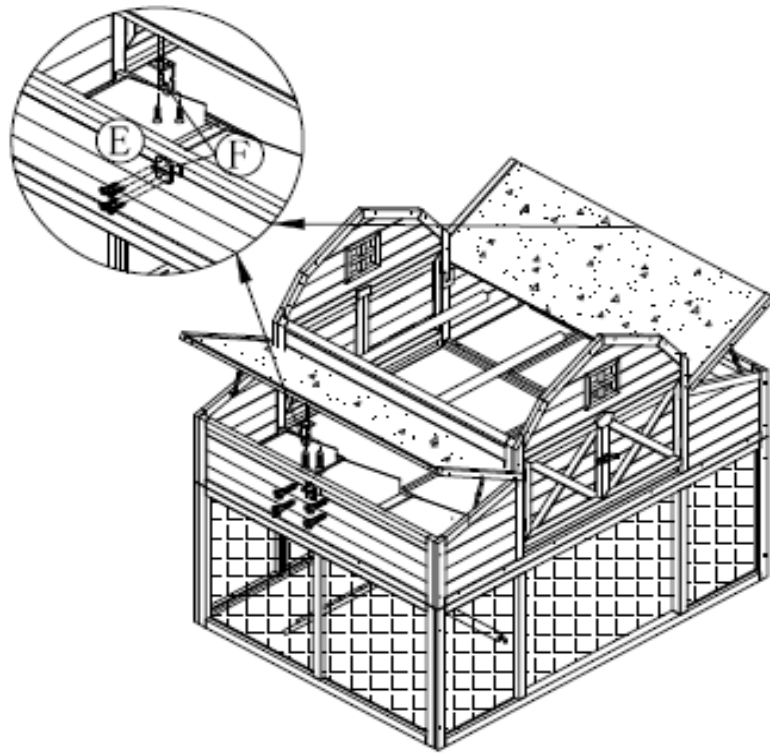

Step 12: Attach the middle roof panels (12) and the top roof panels (13) with screws (C).

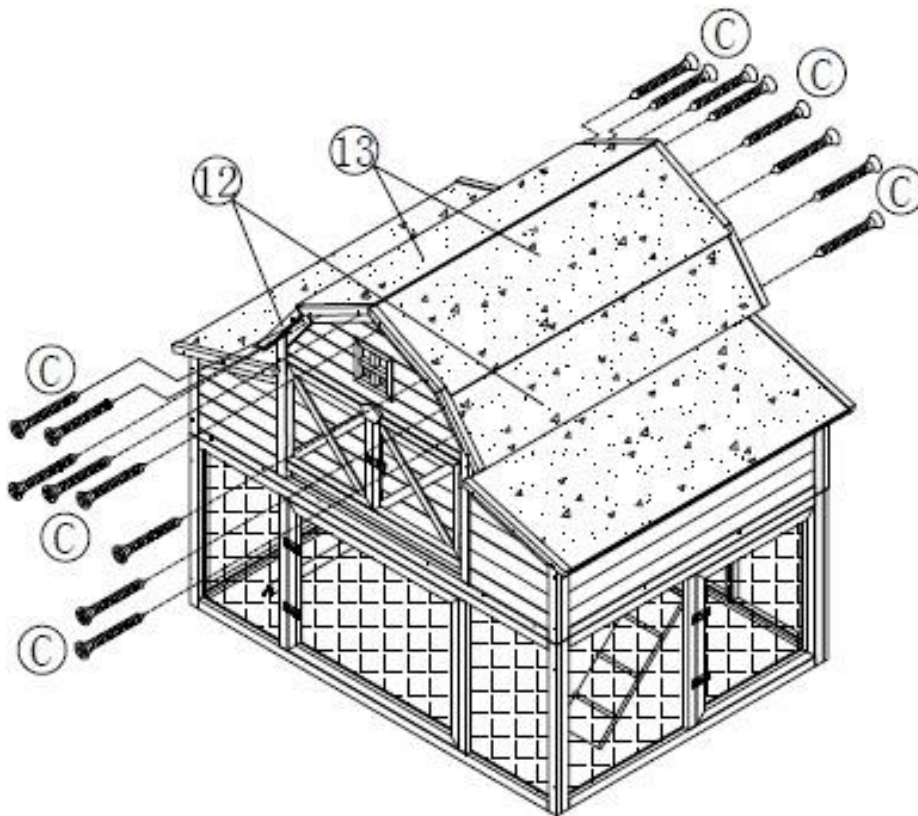

Step 13: Attach the roof cap (20) with screws (D) as shown.

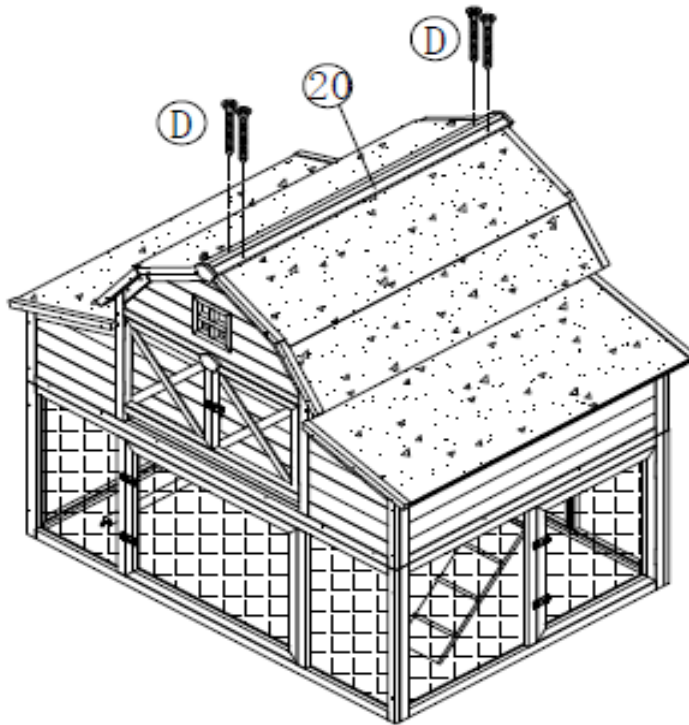

Step 14: Place the drawers (21) in the front and back coop panels as shown.

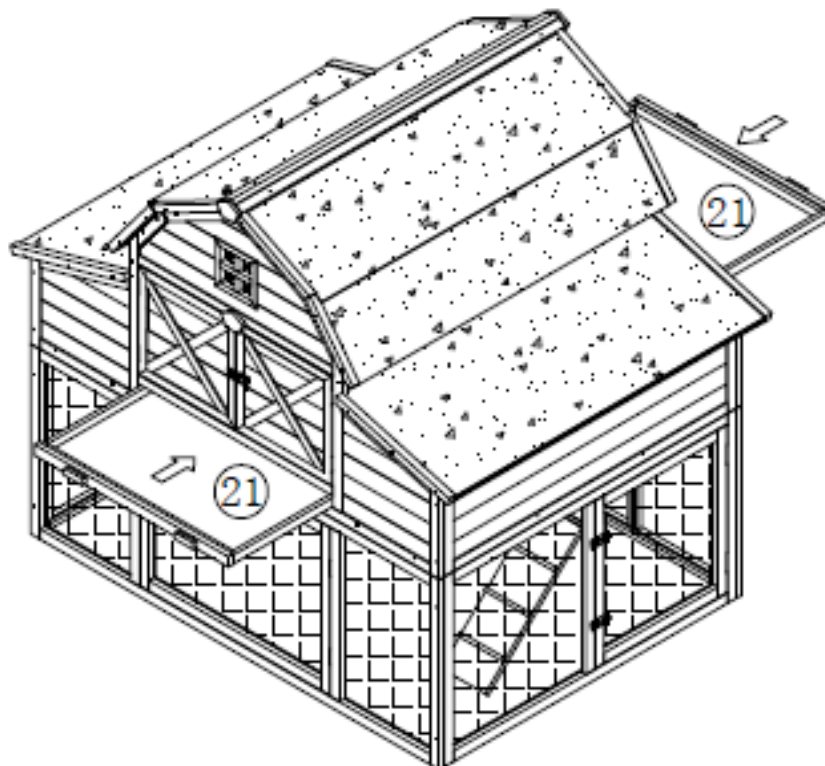

Finished Coop

