

HOBART®

OM-272 158A

2015-09

Endeavor Series™ Auto-Darkening Welding Helmets

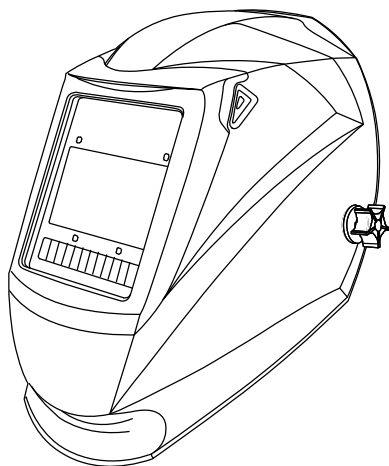

OWNER'S MANUAL



Find us on
Facebook



www.HobartWelders.com

TABLE OF CONTENTS

SECTION 1 – WELDING HELMET SAFETY PRECAUTIONS –READ BEFORE USING	1
1-1. Symbol Usage	1
1-2. Arc Welding Hazards	1
1-3. Proposition 65 Warnings	3
1-4. Lens Shade Selection Table	3
1-5. Principal Safety Standards	3
SECTION 2 – SPECIFICATIONS	4
SECTION 3 – OPERATING INSTRUCTIONS	5
3-1. Helmet Controls	5
3-2. Reset Button And Low Battery Indicator	5
3-3. Lens Delay Control	6
3-4. Variable Shade Control (No. 8 – 13)	6
3-5. Sensitivity/Grind Mode Control	7
SECTION 4 – ADJUSTING HEADGEAR	8
SECTION 5 – REPLACING THE LENS COVERS	9
5-1. Replacing Outside Lens Cover	9
5-2. Replacing Inside Lens Cover	10
SECTION 6 – REPLACING THE BATTERIES	11
SECTION 7 – INSTALLING OPTIONAL MAGNIFYING LENS	11
SECTION 8 – MAINTENANCE	12
SECTION 9 – TROUBLESHOOTING	12
SECTION 10 – PARTS LIST	13
SECTION 11 – LIMITED WARRANTY	13

SECTION 1 – WELDING HELMET SAFETY PRECAUTIONS – READ BEFORE USING

helmet 2013-09

-  Protect yourself and others from injury — read, follow, and save these important safety precautions and operating instructions.

1-1. Symbol Usage



DANGER! – Indicates a hazardous situation which, if not avoided, will result in death or serious injury. The possible hazards are shown in the adjoining symbols or explained in the text.

 Indicates special instructions.



Indicates a hazardous situation which, if not avoided, could result in death or serious injury. The possible hazards are shown in the adjoining symbols or explained in the text.

This group of symbols means Warning! Watch Out! ELECTRIC SHOCK, MOVING PARTS, and HOT PARTS hazards. Consult symbols and related instructions below for necessary actions to avoid the hazards.

NOTICE – Indicates statements not related to personal injury.

1-2. Arc Welding Hazards

-  Only qualified persons should install, operate, maintain, and repair this unit.



ARC RAYS can burn eyes and skin.

Arc rays from the welding process produce intense visible and invisible (ultraviolet and infrared) rays that can burn eyes and skin. Sparks fly off from the weld.

- Wear a welding helmet fitted with a proper shade of filter to protect your face and eyes when welding or watching (see ANSI Z49.1 and Z87.1 listed in Safety Standards). Refer to Lens Shade Selection table in Section 1-4.
- Wear approved safety glasses with side shields under your helmet.
- Use protective screens or barriers to protect others from flash, glare, and sparks; warn others not to watch the arc.
- Wear body protection made from durable, flame-resistant material (leather, heavy cotton, wool). Body protection includes oil-free clothing such as leather gloves, heavy shirt, cuffless trousers, high shoes, and a cap.
- Before welding, adjust the auto-darkening lens sensitivity setting to meet the application.
- Stop welding immediately if the auto-darkening lens does not darken when the arc is struck. See the Owner's Manual for more information.

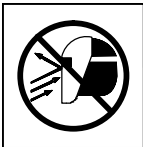

WELDING HELMETS do not provide unlimited eye, ear, and face protection.

Arc rays from the welding process produce intense visible and invisible (ultraviolet and infrared) rays that can burn eyes and skin. Sparks fly off from the weld.

- Use impact resistant safety spectacles or goggles and ear protection at all times when using this welding helmet.
- Do not use this helmet while working with or around explosives or corrosive liquids.
- Do not weld in the overhead position while using this helmet.
- Inspect the auto-lens frequently. Immediately replace any scratched, cracked, or pitted cover lenses or auto-lenses.

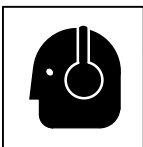

NOISE can damage hearing.

Noise from some processes or equipment can damage hearing.

- Wear approved ear protection if noise level is high.

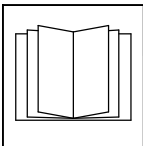

READ INSTRUCTIONS.

- Read and follow all labels and the Owner's Manual carefully before installing, operating, or servicing unit. Read the safety information at the beginning of the manual and in each section.

- Use only genuine replacement parts from the manufacturer.
- Perform maintenance and service according to the Owner's Manuals, industry standards, and national, state, and local codes.





FUMES AND GASES can be hazardous.

Welding produces fumes and gases. Breathing these fumes and gases can be hazardous to your health.

- Keep your head out of the fumes. Do not breathe the fumes.
- If inside, ventilate the area and/or use local forced ventilation at the arc to remove welding fumes and gases. The recommended way to determine adequate ventilation is to sample for the composition and quantity of fumes and gases to which personnel are exposed.
- If ventilation is poor, wear an approved air-supplied respirator.
- Read and understand the Safety Data Sheets (SDSs) and the manufacturer's instructions for adhesives, coatings, cleaners, consumables, coolants, degreasers, fluxes, and metals.
- Work in a confined space only if it is well ventilated, or while wearing an air-supplied respirator. Always have a trained watchperson nearby. Welding fumes and gases can displace air and lower the oxygen level causing injury or death. Be sure the breathing air is safe.
- Do not weld in locations near degreasing, cleaning, or spraying operations. The heat and rays of the arc can react with vapors to form highly toxic and irritating gases.
- Do not weld on coated metals, such as galvanized, lead, or cadmium plated steel, unless the coating is removed from the weld area, the area is well ventilated, and while wearing an air-supplied respirator. The coatings and any metals containing these elements can give off toxic fumes if welded.

1-3. Proposition 65 Warnings

 Welding or cutting equipment produces fumes or gases which contain chemicals known to the State of California to cause birth defects and, in some cases, cancer. (California Health & Safety Code Section 25249.5 et seq.)

 This product contains chemicals, including lead, known to the state of California to cause cancer, birth defects, or other reproductive harm. *Wash hands after use.*

1-4. Lens Shade Selection Table

Process	Electrode Size in. (mm)	Arc Current in Amperes	Minimum Protective Shade No.	Suggested Shade No. (Comfort)*
Shielded Metal Arc Welding (SMAW)	Less than 3/32 (2.4) 3/32–5/32 (2.4–4.0) 5/32–1/4 (4.0–6.4) More than 1/4 (6.4)	Less than 60	7	—
		60–160	8	10
		160–250	10	12
		250–550	11	14
Gas Metal Arc Welding (GMAW) Flux Cored Arc Welding (FCAW)		Less than 60	7	—
		60–160	10	11
		160–250	10	12
		250–500	10	14
Gas Tungsten Arc Welding (TIG)		Less than 50	8	10
		50–150	8	12
		150–500	10	14
Air Carbon Arc Cutting (CAC-A)	Light Heavy	Less than 500	10	12
		500–1000	11	14
Plasma Arc Cutting (PAC)		Less than 20	4	4
		20–40	5	5
		40–60	6	6
		60–80	8	8
		80–300	8	9
		300–400	9	12
Plasma Arc Welding (PAW)		Less than 20	6	6–8
		20–100	8	10
		100–400	10	12
		400–800	11	14

Reference: ANSI Z49.1:2005



* Start with a shade that is too dark to see the weld zone. Then, go to a lighter shade which gives a sufficient view of the weld zone without going below the minimum.

1-5. Principal Safety Standards

Safety in Welding, Cutting, and Allied Processes, ANSI Standard Z49.1, is available as a free download from the American Welding Society at <http://www.aws.org> or purchased from Global Engineering Documents (phone: 1-877-413-5184, website: www.global.ihc.com).

Safe Practice For Occupational And Educational Eye And Face Protection, ANSI Standard Z87.1, from American National Standards Institute, 25 West 43rd Street, New York, NY 10036 (phone: 212-642-4900, website: www.ansi.org).

SECTION 2 – SPECIFICATIONS

Cartridge Dimensions	4.53 x 5.2 x 0.39 in. (115 x 132 x 10 mm)
Viewing Field	3.82 x 2.36 in. (97 x 60 mm); 9.02 in ² (58.2 cm ²)
Reaction Time	0.000067 Second (1/15,000 Second)
Available Shades	Darkened State: No. 8 – No. 13 / Light State: No. 3 Provides Continuous UV And IR Protection
Sensors	Independent/Redundant (Four)
Operating Temperature	23°F to 131°F / -5°C to +55°C  When stored in extremely cold temperatures, warm helmet to ambient temperature before welding.
Storage Temperature	14°F to 158°F / -10°C to +70°C  When stored in extremely cold temperatures, warm helmet to ambient temperature before welding.
Power Supply	CR2450 Lithium Batteries (2)
Total Weight	19.4 oz (550 g)
Standards	ANSI Z87.1-2010 and DIN/CE/TUV/CSA
Warranty	Two Years From Date Of Purchase (See Section 11)
Sensitivity/Grind Mode Control	Adjusts For Varying Ambient Light And Welding Arc
Delay Control	Slows Lens Dark-To-Light State Between 0.1 And 1.0 Seconds
Automatic Power Off	Shuts Lens Off 15–20 Minutes After Welding Stops
Low Battery Indicator	Red LED Illuminates To Indicate 2–3 Days Remaining Battery Life

Notes

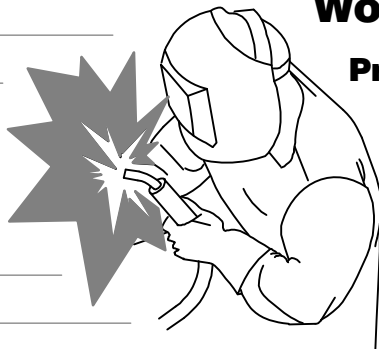

Work like a Pro!

Pros weld and cut safely. Read the safety rules at the beginning of this manual.

SECTION 3 – OPERATING INSTRUCTIONS

3-1. Helmet Controls

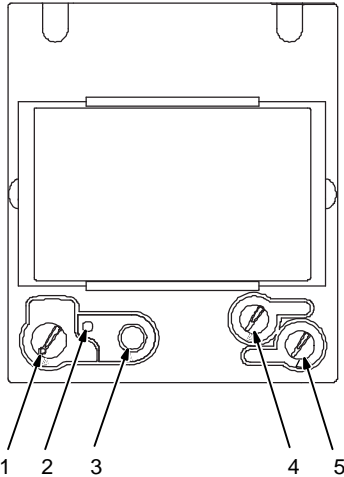
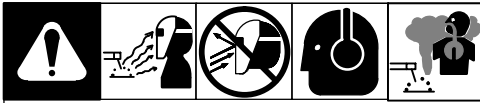

- 1 Sensitivity/Grind Mode Control (See Section 3-5)
- 2 Low Battery Indicator (See Section 3-2)
- 3 Reset Button (See Section 3-2)
- 4 Lens Delay Control (See Section 3-3)
- 5 Variable Shade Control (See Section 3-4)

3-2. Reset Button And Low Battery Indicator

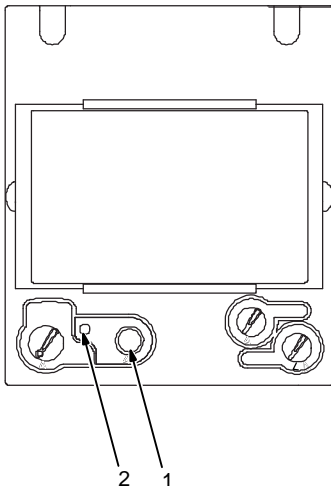
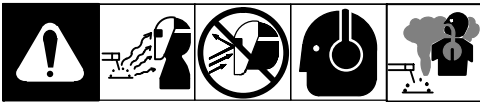

 The auto-darkening lens turns on (darkens) automatically when welding begins and turns off 15–20 minutes after welding stops.

1 Reset Button

Press Reset button to check if the lens is working properly.

When the Reset button is pressed, the lens should darken twice and return to the clear state. Do not use the helmet if the lens does not function as described. (See Section 9, Troubleshooting.)

2 Low Battery Indicator

The low battery indicator lights when 2–3 days of battery life remain.

If battery power is low, install new CR2450 lithium batteries (see Section 6).

3-3. Lens Delay Control

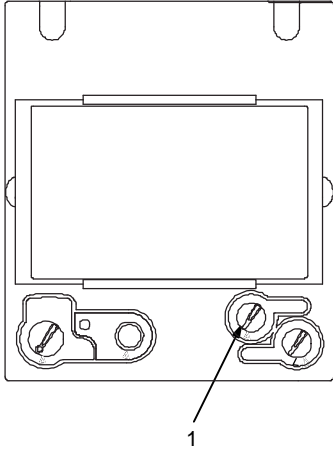
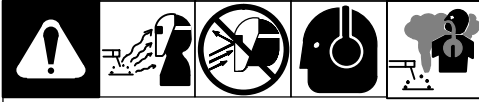

1 Lens Delay Control

The lens delay control is used to adjust the time for the lens to switch to the clear state after welding.

The delay is particularly useful in eliminating bright after-rays present in higher amperage applications where the molten puddle remains bright momentarily after welding.

Lens delay adjusts from min (0.10 second) to max (1.0 second).

3-4. Variable Shade Control (No. 8 – 13)

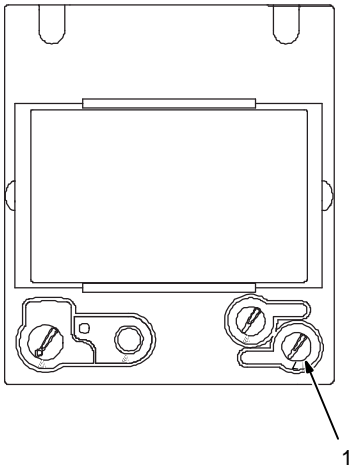

1 Variable Shade Control (No. 8 – 13)

Use the control to adjust the lens shade in the darkened state. Use the table in Section 1-4 to select proper shade control setting based on your welding process.

Start at shade 12 and adjust lighter to suit the welding application and your personal preference.

3-5. Sensitivity/Grind Mode Control

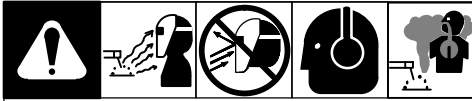

1 Sensitivity/Grind Mode Control

Weld Mode

Use control to make the lens more responsive to different light levels in various welding processes. **Use a Mid-Range or 30-50% sensitivity setting for most applications.**

It may be necessary to adjust helmet sensitivity to accommodate different lighting conditions or if lens is flashing On and Off. Adjust helmet sensitivity as follows:

 *Adjust helmet sensitivity in lighting conditions helmet will be used in.*

- Turn sensitivity control to lowest setting.
- Press Reset button to turn helmet On. Helmet lens will darken twice and then clear.
- Face the helmet in the direction of use, exposing it to the surrounding light conditions.
- Gradually turn sensitivity setting clockwise until the lens darkens, then turn sensitivity control counterclockwise until slightly past setting where lens clears. Helmet is ready for use. Slight readjustment may be necessary for certain applications or if lens is flashing on and off.

Grind Mode

 *Do not weld in the Grind mode; the lens will not darken.*

To use the Grind mode, turn the Sensitivity control clockwise to the far right position (Grind). To resume welding, return the control to the desired sensitivity setting.

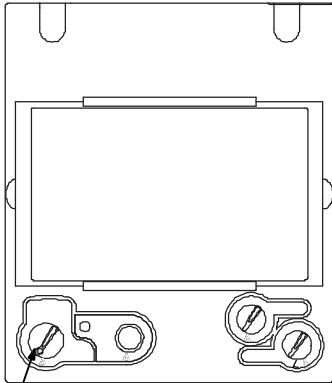

1

Recommended Sensitivity Settings

Stick Electrode	Mid-Range
Short Circuiting (MIG)	Low/Mid-Range
Pulsed & Spray (MIG)	Mid-Range
Gas Tungsten Arc (TIG)	Mid/High-Range
Plasma Arc Cutting/Welding	Low/Mid-Range
Grind Mode	Grind Position – Far Right (Clockwise)

SECTION 4 – ADJUSTING HEADGEAR

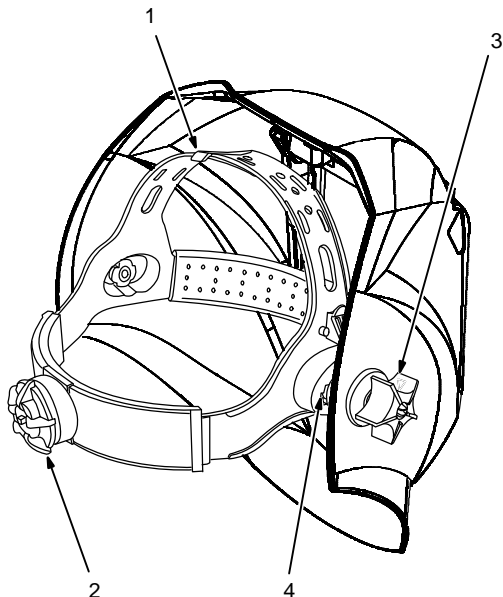
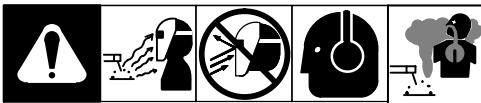

☞ *There are four headgear adjustments: headgear top, tightness, angle adjustment, and distance adjustment.*

1 Headgear Top

Adjusts headgear for proper depth on the head to ensure correct balance and stability.

2 Headgear Tightness

To adjust, press knob and turn left or right to desired tightness.

☞ *If adjustment is limited, it may be necessary to remove the comfort cushion.*

3 Distance Adjustment

Adjusts the distance between the face and the lens. To adjust, loosen both outside tension knobs and press inward to free from adjustment slots. Move headgear forward or back to desired position and retighten. (Both sides must be equally positioned for proper vision.)

4 Angle Adjustment

Four pins on the right side of the headband top provide adjustment for the forward tilt of the helmet. To adjust, loosen the right outside tension adjustment knob then lift the control arm tab and move it to the desired position. Retighten tension adjustment knob.

☞ *When using the back distance adjustment positions, only the back three angle adjustment pins can be used.*

SECTION 5 – REPLACING THE LENS COVERS

5-1. Replacing Outside Lens Cover

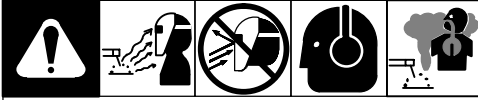

⚠ Never use the auto-darkening lens without the inside and outside lens covers properly installed. Welding spatter will damage the auto-darkening lens and void the warranty.

- 1 Front Lens Holder
- 2 Release Points
- 3 Lens Cover
- 4 Gasket

Remove front lens holder by pressing release points and pulling the holder away from the helmet.

Remove lens cover and gasket from the holder. Replace lens cover and reinstall gasket and lens in holder. Reinstall holder in helmet.

☞ Be sure the flat side of lens cover gasket faces the lens cover holder.

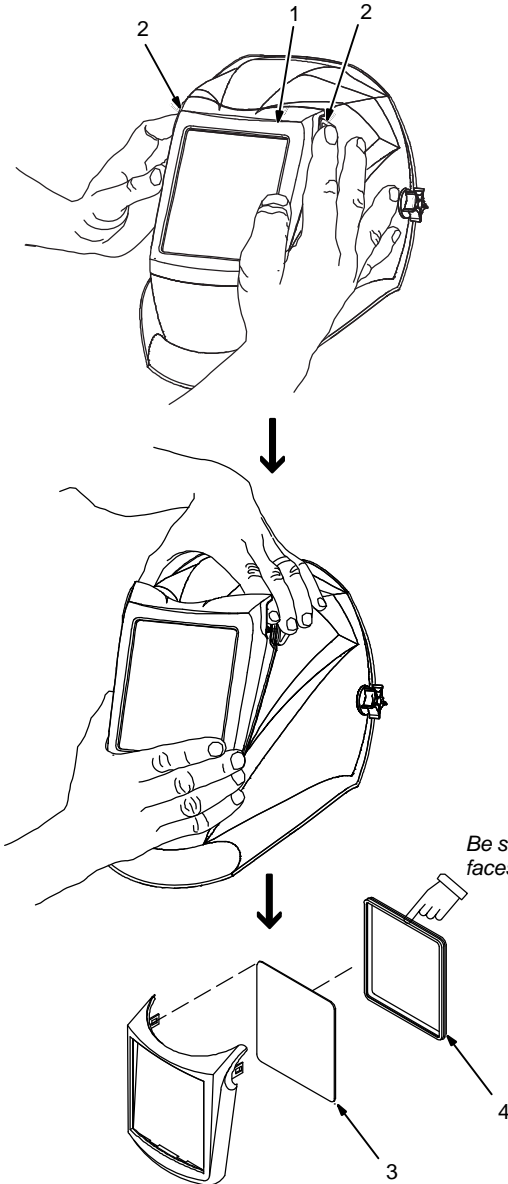

5-2. Replacing Inside Lens Cover

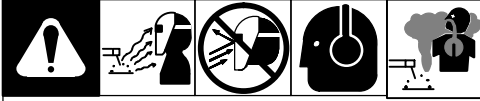

⚠ Never use the auto-darkening lens without the inside and outside lens covers properly installed. Welding spatter will damage the auto-darkening lens and void the warranty.

Remove front lens holder (see Section 5-1). Remove auto-darkening lens assembly by pressing it gently from inside the helmet. (Assembly comes out front of helmet.)

- 1 Lens Assembly
- 2 Inside Lens Cover

Remove the inside lens cover by prying the cover up at either thumbnail opening at each side of the cover. Slide cover it out of frame. Replace lens cover and reinstall the assembly in the helmet by reversing the above procedure.

☞ Be sure the cover lens is seated properly (flat) to prevent fogging.

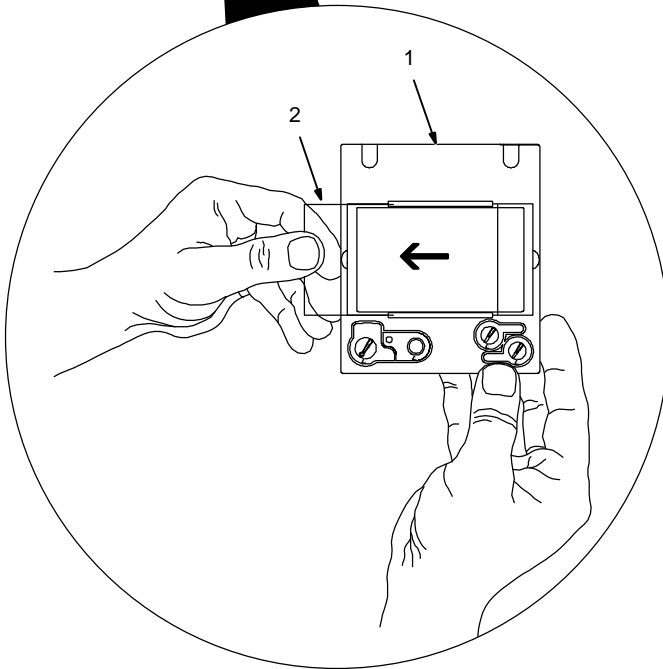
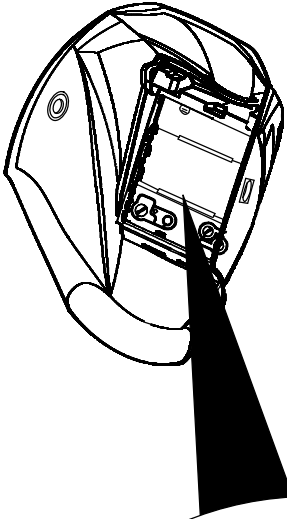

SECTION 6 – REPLACING THE BATTERIES

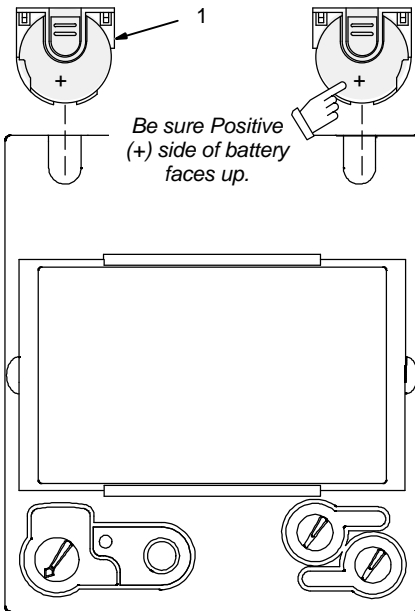
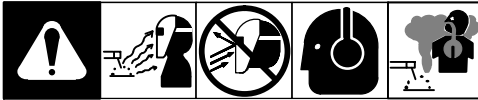

To replace the batteries, remove the auto-darkening lens assembly (see Section 5-2).

1 Battery Tray

After removing the lens assembly, slide the battery holding trays out and remove the old batteries.

Replace with CR2450 lithium type batteries (2 required) or equivalent (Miller Part No. 217043).

 *Be sure Positive (+) side of the battery faces up (toward inside of helmet).*

Reinstall the battery trays. To test, press the Reset button. The lens should flash dark twice. Reinstall the lens assembly.

 *Left and right battery trays are not interchangeable. The auto-darkening helmet will not work if battery trays are installed on the wrong sides.*

OTOS / 804 847

SECTION 7 – INSTALLING OPTIONAL MAGNIFYING LENS

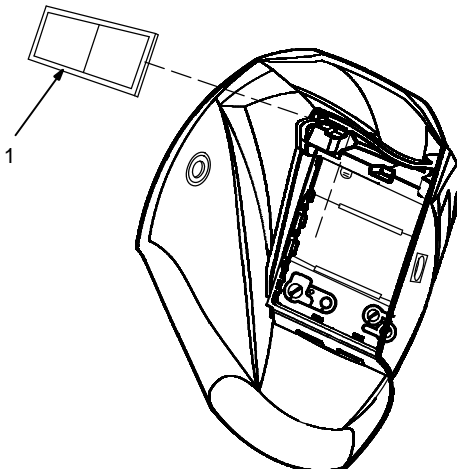

1 Optional Magnifying Lens

Starting at the top, slide magnifying lens into the helmet retaining brackets. Align the magnifying lens with the auto-darkening lens assembly.

Reverse procedure to remove magnifying lens.

 *To prevent lens fogging, install flat side of magnifying lens toward auto-darkening lens.*

SECTION 8 – MAINTENANCE

NOTICE – Never use solvents or abrasive cleaning detergents.

NOTICE – Do not immerse the lens assembly in water.

The helmet requires little maintenance. However, for best performance clean after each use. Using a soft cloth dampened with a mild soap and water solution, wipe the cover lenses clean. Allow to air dry. Occasionally, the filter lens and sensors should be cleaned by gently wiping with a soft, dry cloth.

SECTION 9 – TROUBLESHOOTING



Trouble	Remedy
Auto lens not ON – auto-lens will not darken momentarily when the Reset button is pressed.	Check batteries and verify they are in good condition and installed properly. Also, check battery surfaces and contacts and clean if necessary. Check battery for proper contact and gently adjust contact points if necessary. This is particularly important if the helmet has been dropped. Verify left and right battery trays are installed on the correct sides.
Not switching – auto-lens stays light and will not darken when welding.	Stop welding immediately. Press the Reset button if lens is Auto-On type. If lens is Manual-On type, make sure the lens is turned On. If power is on, review the sensitivity recommendations and adjust sensitivity. Clean lens cover and sensors of any obstructions. Make sure the sensors are facing the arc; angles of 45° or more may not allow the arc light to reach the sensors.
Not Switching – auto-lens stays dark after the weld arc is extinguished, or the auto-lens stays dark when no arc is present.	Fine-tune the sensitivity setting by making small adjustments to the control by turning it toward the “min” setting. In extreme light conditions, it may be necessary to reduce the surrounding light levels.
Sections of the auto-lens are not going dark, distinct lines separate the light and dark areas.	Stop welding immediately. The auto-lens may be cracked which can be caused by the impact of dropping the helmet. Weld spatter on the auto lens may also cause cracking. (The lens may need to be replaced; most cracked lenses are not covered by warranty).
Switching or Flickering – the auto-lens darkens then lightens while the welding arc is present.	Review the sensitivity setting recommendations and increase the sensitivity if possible. Be sure the arc sensors are not being blocked from direct access to the arc light. Check the lens cover for dirt and spatter that may be blocking the arc sensors. Increasing Lens Delay 0.1 – 0.3 second may also reduce switching.
Inconsistent or lighter auto-lens shading in the dark-state, noticeable on the outside edges and corners.	Referred to as an angle of view effect, auto-darkening lenses have an optimum viewing angle. The optimum viewing angle is perpendicular or 90° to the surface of the auto-lens. When that angle of view varies in the dark-state, welders may notice slightly lighter areas at the outside edges and the corners of the lens. This is normal and does not represent any health or safety hazard. This effect may also be more noticeable in applications where magnifying lenses are used.

SECTION 10 – PARTS LIST

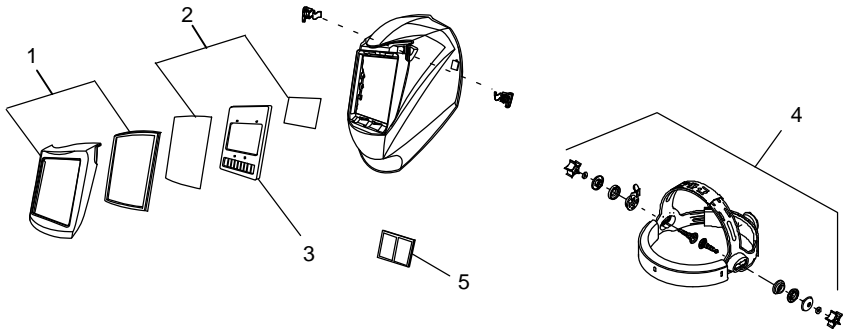

Figure 10-1. Endeavor Series Auto-Darkening Welding Helmets

Item No.	Part No.	Description	Quantity
----------	----------	-------------	----------

Figure 10-1. Endeavor Series Auto-Darkening Welding Helmets

1	770831	Kit, Replacement Frame And Gasket	1
2	770586	Kit, Replacement Clear Lens (Includes 5 Outside / 2 Inside)	1
3	770823	Lens, Auto-Darkening (ADF Cartridge Assembly)	1
4	770613	Battery, Non-rechargeable CR2450	2
5	770274	Headgear, Ratcheting Adjustable	1
	◆770274	Diopter Lens, 150X (1.50 Magnification)	1
	◆770276	Diopter Lens, 200X (2.00 Magnification)	1
	◆770277	Diopter Lens, 250X (2.50 Magnification)	1

◆ Optional

SECTION 11 – LIMITED WARRANTY

LIMITED WARRANTY – Subject to the terms and conditions below. Hobart Brothers Co., Troy, Ohio, warrants to its original retail purchaser that the new Hobart equipment sold after the effective date of this limited warranty is free of defects in material and workmanship at the time it is purchased at the retailer. **THIS WARRANTY IS EXPRESSLY IN LIEU OF ALL OTHER WARRANTIES, EXPRESS OR IMPLIED, INCLUDING THE WARRANTIES OR MERCHANTABILITY AND FITNESS.**

Hobart auto-darkening lens helmets are warranted for two (2) years from the date of purchase. **Proof of purchase is required for warranty transactions so it is imperative that a copy of the original invoice or sales receipt be retained.**

For warranty transactions, contact your original Hobart retailer or call 1-800-332-3281

HOBART®

Hobart Brothers Co.
2200 Corporate Drive
Troy, OH 45373 USA
Phone: 800-332-3281



Visit our website at
www.HobartWelders.com