

Because you're not like everybody else,

luma  TM
comfort



EVAPORATIVE COOLER
EC45S
OWNER'S MANUAL

BECAUSE YOU'RE NOT LIKE EVERYONE ELSE.

And neither are we. Always at the forefront of our industry, our goal is to offer the best quality product and consumer value on the market. Our team is constantly pushing the boundaries of innovation and design to create exceptional products to help you achieve a more comfortable living or work space.

Our goal is to ensure that every Luma Comfort customer is 100% satisfied with their product. If you have any questions or concerns regarding your product, or if you would simply like to share an idea with us, please feel free to contact us. Our friendly and knowledgeable customer support team is here for you. Call us today at **866-737-6390** or email **support@lumacomfort.com**.

For future reference, we recommend you attach a copy of your sales receipt here and record the following information. You will need this information if it becomes necessary to contact the manufacturer for service inquiries.

Date of Purchase: _____

Serial Number: _____

Model Number: _____



Connect with us online.

● ● ● CONTENTS

Important Safety Information.....	4
Get To Know Your Evaporative Cooler.....	5
Product Benefits.....	5
Parts List.....	5
Parts Diagram.....	6
Operating Instructions.....	7
Set Up.....	7
Filling the Water Tank.....	7
Using the Ice Pack.....	8
The Control & Display Panels.....	8
Using the Remote Control.....	11
Maintenance.....	11
Exterior Cleaning.....	12
Dust Filter & Cooling Pad Cleaning.....	12
Water Tank Cleaning.....	13
Water Pump Maintenance.....	13
Technical Support.....	14
Product Specifications.....	14
Troubleshooting.....	15
Warranty.....	17

SAVE THESE INSTRUCTIONS



Please carefully read this manual before attempting to use this evaporative cooler. For your own safety, comply with all safety instructions and warnings contained in this owner's manual to prevent personal injury or property damage.

Say Goodbye to Ugly Products

● ● ● IMPORTANT SAFETY INFORMATION



These instructions are not meant to cover every possible condition and situation that may occur. Please read all instructions before using this evaporative cooler. Failure to carefully read all instructions may result in possible electric shock or fire hazard, and will void the manufacturer's warranty.

1. Use this evaporative cooler only as instructed in this owner's manual. Other uses may cause electric shock, injury or fire.
2. Close supervision is required if this cooler is used near children or pets.
3. To protect against electric shock, do not immerse this cooler or its plug and cord in water.
4. If the cooler is being transported or will not be in use, disconnect it from the power supply by tightly gripping the plug and pulling it from the power outlet. Do not disconnect the power supply by pulling on the evaporative cooler's power cord.
5. Avoid contact with any of the evaporative cooler's moving parts.
6. Place the evaporative cooler on a level surface.
7. This evaporative cooler is intended to fit into a matching receptacle. Under no circumstances should the plug be altered in any way. An improper connection can result in electric shock. 
8. If possible, avoid using extension cords with this evaporative cooler. If an extension cord is absolutely necessary, do not use more than one extension cord to operate more than one cooler.
9. Do not insert objects or allow fingers to enter into the cooler's grills, as this may cause electric shock or bodily injury. Do not block or tamper with the evaporative cooler while it is in operation.
10. Do not run the power cord under mats or carpeting, and do not cover the power cord with runners. Arrange the power cord away from room traffic and where it can be tripped over.
11. Do not operate this evaporative cooler in the presence of flammable substances or explosives.
12. Do not place the cooler near an open flame or cooking/heating appliances.
13. If the evaporative cooler will not be in use, empty the tank of any remaining water.
14. If the cooler's plug or power cord is damaged, do not attempt to repair the components yourself. Please contact Luma Comfort's customer service hotline at 1-866-737-6390 or have the unit examined by an authorized service provider. 

● ● ● GET TO KNOW YOUR EVAPORATIVE COOLER

PRODUCT BENEFITS

- Designed to cool smaller areas such as single rooms, office cubicles and personal spaces
- Sleek, modern design makes it an attractive addition to your home
- Tower body shape saves space
- High-efficiency, rigid cooling pad holds more water
- Powerful motor results in more powerful airflow, faster evaporation and cooler air
- Consumes as much electricity as your typical 45 watt light bulb
- Eco-friendly evaporative cooling system cools the air by the natural process of evaporating water with no Freon or harmful chemicals
- Adds moisture to dry environments and eliminates airborne dust particles

PARTS LIST

Check to ensure the following parts are included with your product:

- Evaporative cooler
- Ice Pack
- Remote control
- CR2032 3V battery

PARTS DIAGRAM

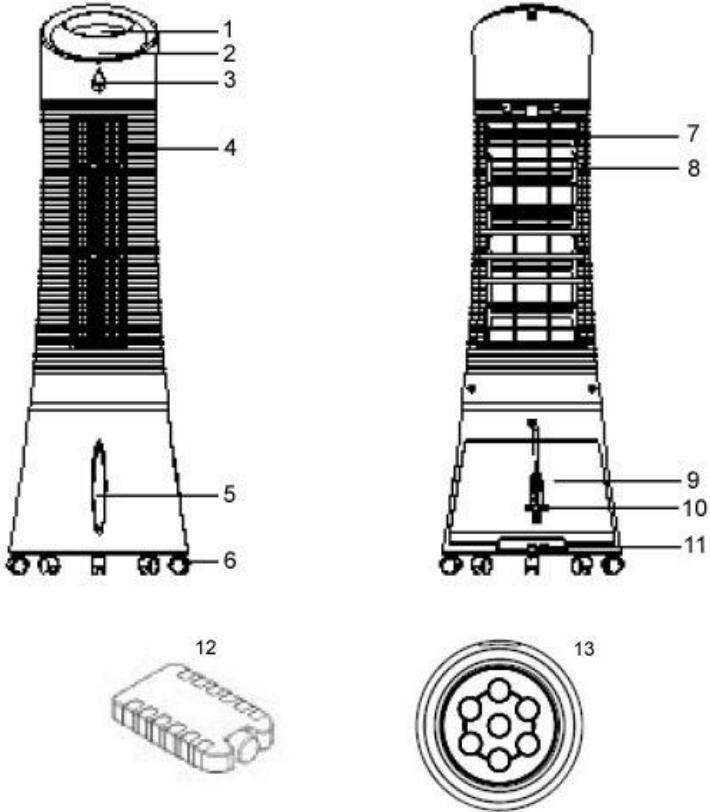

- | | | |
|----------------------------|-------------------------|-----------------------|
| 1. Control panel | 6. Caster | 10. Power cord |
| 2. Display panel | 7. Dustproof air filter | 11. Water tank switch |
| 3. Remote control receiver | 8. Cooling pad slot | 12. Ice pack |
| 4. Air louvers | 9. Water tank | 13. Remote control |
| 5. Water level indicator | | |

● ● ● OPERATING INSTRUCTIONS

SET UP

Carefully remove all packaging materials and retain for future storage/use. Make sure there is no residual foam left in any of the components. No tools will be required to assemble this evaporative cooler.

Place the cooler on a firm, level surface before proceeding. Before using the evaporative cooler for the first time, we recommend cleaning the tank with a solution of warm water and light detergent.

FILLING THE WATER TANK

1. Locate the water tank switch and move it counterclockwise 90° to unlock the tank. Pull out the water tank from the back of the cooler.
2. Fill the tank with clean water. Pay attention to the water level indicator located on the front of the cooler to avoid overfilling the evaporative cooler. Do not fill the tank above the MAX water level line or below the MIN water level line. The approximate tank size of the EC45S is 1.6 gallons (6 liters).
3. Push the water tank back into the rear of the unit and move the water tank switch clockwise 90° to lock the water tank back into place.

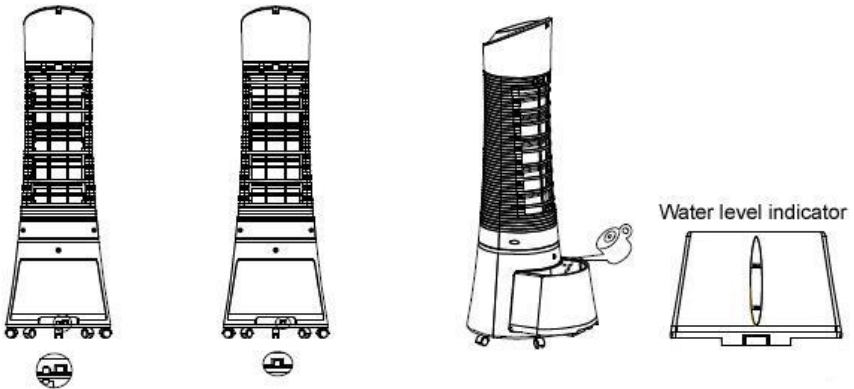

USING THE ICE PACK

The Luma Comfort EC45S tower evaporative cooler includes an optional ice pack for added cooling.

1. Place the ice pack in the freezer until frozen. Do not open the ice pack or ingest its contents.
2. Open the water tank and put the ice pack into one of the water tank's chambers.
3. The ice pack is not necessary for operation, but will help enhance the cooling effect in higher temperatures.
4. The ice pack will last approximately 4 hours before melting.

THE CONTROL & DISPLAY PANELS

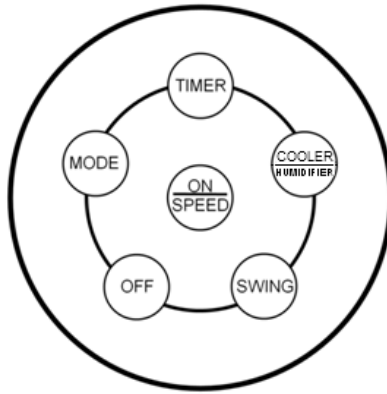

After the tank is filled with water, connect the evaporative cooler to a power outlet. The unit will beep twice, indicating that the power source is connected. The cooler will be in standby mode at this time.

ON/SPEED & OFF Buttons

Press the ON/SPEED button to turn on the evaporative cooler.

To adjust the fan speed, press ON/SPEED button again until your desired speed has been reached. The current fan speed will be indicated on the display panel. To turn the unit off and revert back to standby mode, press the OFF button.

Fan Speed Indicators:



LOW



MEDIUM



HIGH

COOL/HUMIDIFIER Button



**Cooler/
Humidifier
Indicator**

After the desired fan speed has been selected, press the COOLER/HUMIDIFIER button to activate the cooling/humidifying function. This powers the water pump, cools the air and adds moisture to your air at the same time. The blue cooling icon will also be visible on the display panel.

MODE Button

The EC110S has 3 different automatic airflow modes. Setting the airflow mode is optional.



Manual Mode

Manual Mode – Indicated by the three circular icons on the display panel, this allows you to set the fan speeds manually.



Natural Mode

Natural Mode – Indicated by the palm tree icon on the display panel, this setting will automatically vary the airflow speed between low, medium and high.



Sleep Mode

Sleep Mode – Indicated by the moon icon on the display panel, this setting will gradually lower the speed at different intervals, depending on the selected fan speed. If the fan speed is set to 3, the cooler will run for 30 minutes on high speed, 30 minutes on medium speed, and then continue to operate on low speed. If the fan speed is set to 2, the cooler will run for 30 minutes on medium speed and then continue to operate on low speed. If the fan speed is set to 1, the cooler will continuously run on low speed.

TIMER Button

This evaporative cooler is equipped with a 7.5 hour programmable timer. To set the timer, press the TIMER button. Each press of this button will add 0.5 hours to the set time.

The set time will be indicated in the middle of the display panel.

SWING Button



Swing Indicator

To activate the oscillation feature, press the SWING button. The fan head will automatically move from side to side, which increases air circulation and distributes air more evenly.

USING THE REMOTE CONTROL

The Luma Comfort EC45S is equipped with a remote control. A CR2032 3V coin-type replacement battery is included for your convenience.

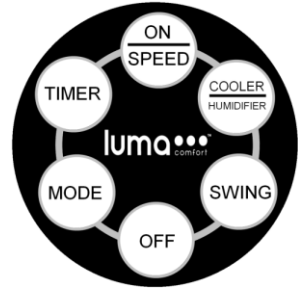

1. To put the battery inside the remote control, insert a coin into the slot located on the back of the remote control and turn it as directed on the remote control.
2. To use the remote control, aim it at the unit's remote control receiver and select one of the functions on the remote control. The effective distance is approximately 24".
 - ON/SPEED = Turns the power on and adjusts the fan speed
 - OFF = Turns the power off
 - TIMER = Activates timer function of up to 7.5 hours
 - SWING = Activates oscillating air louvers
 - COOLER/HUMIDIFIER = Activates cooling/humidification function
 - MODE = Adjusts the airflow mode

● ● ● MAINTENANCE

Always unplug the evaporative cooler from the power supply before servicing or cleaning.

Regular cleaning and maintenance is an essential step in maintaining the longevity of your tower evaporative cooler and ensuring that it operates free of defects. Maintain your evaporative cooler by following the steps on the following pages.

If the evaporative cooler will not be in use for an extended period of time, place the unit back in its original carton and keep it stored in a clean, dry place.

EXTERIOR CLEANING

1. Use a soft cloth and a mild soap and warm water solution to clean the unit's exterior. Do not use harsh cleaners, gasoline, paint thinner, benzene, etc., as these substances can damage the evaporative cooler.
2. Thoroughly dry all of the cooler's parts with a soft cloth before reconnecting the unit to the power supply.

DUST FILTER & COOLING PAD CLEANING

To prevent the cooling pad and filter from becoming clogged with dust, mineral deposits and other buildup, we recommend that it be cleaned at least once a month.

1. Remove the dust filter from the back of the unit by pushing down on the two tabs located above the filter and pulling it out. Gently scrub it with a soft brush and rinse with water.
2. While the dust filter is off, remove the cooling pad frame from the back of the unit. Rinse the pad with clean water to remove dust. For a more thorough cleaning, use a diluted vinegar solution to wash the pad. If necessary, immerse the pad in the diluted vinegar solution for 30 seconds to remove hard water buildup. Be sure to rinse the pad thoroughly with clear water to remove vinegar residue.
3. Allow the filter and the cooling pad to air dry completely before replacing them in the unit.

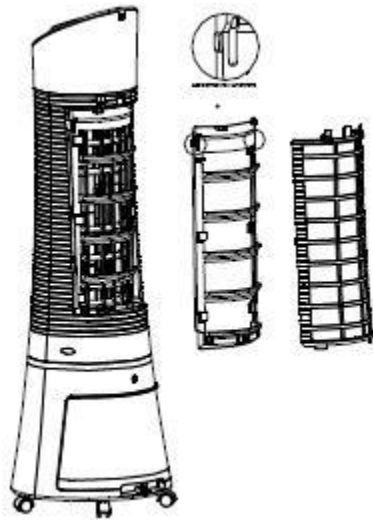

WATER TANK CLEANING

The water tank should be emptied regularly to ensure hygienic use. To empty the tank:

1. Unlock and pull open the water tank.
2. Place a small dish beneath the extended water tank.
3. Remove the white plug from the bottom of the water tank to allow water to drain out into the dish.
4. When empty, replace the plug in the drain. Be sure it is secure to avoid leaking.

In addition, the tank should be cleaned several times a year to remove hard water and mineral deposits. Use a soft, damp cloth to wipe out the interior of the tank. For excessive hard water buildup, use a diluted vinegar solution and rinse thoroughly afterwards.

WATER PUMP MAINTENANCE

Hard water buildup can affect the performance of the cooler's water pump. To prevent malfunctions, clean the pump and internal tubing with a calcium and lime cleaning product (such as CLR) at least once a season.

1. Empty any water from the tank.
2. Pour the cleaner into the water tank so the pump is covered.
3. With the tank closed, allow the pump to soak for 10 to 20 minutes.
4. Remove the cooling pad from the back of the unit.
5. Run the cooler for 30 seconds. This will circulate the cleaning solution through the pump and tubing to remove any leftover mineral deposits. Do not operate longer than 30 seconds, or damage might occur to other parts of the cooler.
6. Rinse the tank and fill it with clean water. Run it for several minutes without the cooling pad in place to ensure the cleaning solution has been rinsed away.
7. Replace cooling pad and dust filter and operate unit as normal.

● ● ● TECHNICAL SUPPORT

Luma Comfort is committed to providing a premier service experience. If you are experiencing any technical issues with your product related to either setup or operation, please contact our product support team at 1-866-737-6390 or support@lumacomfort.com.

PRODUCT SPECIFICATIONS

Model:	EC45S
Product Dimensions:	11.7" x 11.7" x 37.2"
Product Weight:	12.8 pounds
Voltage:	110V – 120V
Wattage:	45W
Coverage Area:	Up to 100 sq. ft.
Tank Size:	1.6 gallons
Fan Speeds:	3
Noise Level (dB):	64
Airflow:	250 CFM
Oscillation:	Yes
Warranty:	1 year manufacturer's warranty

TROUBLESHOOTING

Problem	Possible Cause(s)	Possible Solution
Unit will not power on	Dust filter cover is not completely pushed in	<p>A. Remove the dust filter cover and locate a small prong sticking out of the middle tab at the top of the cover.</p> <p>B. Also locate the hole on the unit in which the prong must be inserted to. If it is not pushed in completely, the unit will not power on.</p> <p>C. Fasten the dust filter cover once again ensuring the prong and all other attachments are pushed in completely.</p>
There is no airflow.	<p>The power cord is not plugged in.</p> <p>The water tank is not locked into the unit.</p>	<p>Check to make sure the plug is plugged into an outlet. The unit should beep twice once the power supply is connected.</p> <p>Make sure the water tank is locked into the back of the unit.</p>

Problem	Possible Cause(s)	Possible Solution
The unit does not cool at all.	<p>There is insufficient water in the tank.</p> <p>The cooler/humidifier button was not pressed.</p> <p>The pump is defective.</p>	<p>Check the water level in the tank and make sure there is enough water.</p> <p>Press the COOLER/HUMIDIFIER button.</p> <p>Contact customer service if there is an issue with the water pump.</p>
The unit does not sufficiently cool.	The cooling pad is not sufficiently saturated with water.	Wait a few minutes for the cooling pad to be fully saturated with water.
Water is coming out of the vents.	The cooling pad may be clogged with debris.	Clean the cooling pad by rinsing it in water and allowing it to thoroughly dry. If the problem persists, contact customer service.



WARRANTY

Luma Comfort products are warranted to be free from defects in workmanship or materials for one (1) year from the date of purchase. If the product is found to be defective within this period, Luma Comfort, at its sole option, will repair or replace any components that fail during normal operation. The repairs or replacement will be made at no charge to the customer for parts and labor, assuming that the customer shall be responsible for all transportation costs to and from Luma Comfort. Luma Comfort retains the right to repair or replace (with a new or newly-refurbished replacement product) the appliance at its sole discretion. This warranty does NOT apply to the following:

- Products without a proof of purchase
- Products purchased from a source other than an authorized Luma Comfort dealer
- Cosmetic damage such as scratches or dents
- Damage caused by service performed by anyone who is not an authorized service provider of Luma Comfort
- Damage in transit
- Damage caused by accident, abuse, misuse, water, flood, fire, improper installation, maintenance negligence, commercial use for a non-commercial unit, acts of God or any other acts of nature or external causes
- Damage to a product caused by modifications or alterations without the written permission of Luma Comfort
- Normal wear and tear of parts that are designed to be replaced, such as filters or batteries
- Power failure and improper power supply such as low voltage, defective wiring or inadequate fuses
- Use of force or damage caused by external influences
- Complete or partially dismantled appliances

THE WARRANTIES AND REMEDIES CONTAINED HEREIN ARE EXCLUSIVE AND IN LIEU OF ALL OTHER WARRANTIES EXPRESS, IMPLIED, OR STATUTORY, INCLUDING ANY LIABILITY ARISING UNDER ANY WARRANTY OF MERCHANTABILITY OR FITNESS FOR A PARTICULAR PURPOSE, STATUTORY OR OTHERWISE. THIS WARRANTY GIVES YOU SPECIFIC LEGAL RIGHTS, WHICH MAY VARY FROM STATE TO STATE.

IN NO EVENT SHALL LUMA COMFORT BE LIABLE FOR ANY INCIDENTAL, SPECIAL, INDIRECT, OR CONSEQUENTIAL DAMAGES, WHETHER RESULTING FROM THE USE, MISUSE, OR INABILITY TO USE THIS PRODUCT OR FROM DEFECTS IN THE PRODUCT. SOME STATES DO NOT ALLOW THE EXCLUSION OF INCIDENTAL OR CONSEQUENTIAL DAMAGES, SO THE ABOVE LIMITATIONS MAY NOT APPLY TO YOU.

If you believe your product is defective, contact Luma Comfort for warranty service at 1-866-737-6390 or support@lumacomfort.com. In your correspondence with Luma Comfort, please describe the problem and request a return material authorization (RMA) number. You will also need to provide the proof of purchase, return shipping address and a daytime phone number.

After a Luma Comfort representative confirms that your product is defective and is still under warranty, you will receive an RMA and return shipping instructions. Products sent to our headquarters without an RMA will be refused.

Say Goodbye to Ugly Products