



SKU:1146315









## Cold Frame Greenhouse

( 36.2in. H x 96in.W x 36.2 in.D)



**Distributed by:**  
**TRACTOR SUPPLY COMPANY**  
**5401 VIRGINIA WAY**  
**BRENTWOOD, TN 37027**  
**For customer support, call:**  
**1-888-376-9601 [www.TractorSupply.com](http://www.TractorSupply.com)**  
**MADE IN CHINA**

# PARTS LIST

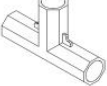
Part	Image	Description	Quantity
1		<b>29.4in.Steel Support</b>	<b>8pcs</b>
2		<b>30.9in.Steel Support</b>	<b>15pcs</b>
3		<b>18.1in.Steel Support</b>	<b>2pcs</b>
4		<b>18.1in.Steel Support</b>	<b>2pcs</b>
5		<b>11.6in.Steel Support</b>	<b>8pcs</b>
6		<b>Cover</b>	<b>1pc</b>
A		<b>3 Way Corner Connector (Model 1-90 degrees)</b>	<b>6pcs</b>
B		<b>4 Way Corner Connector (Model 1-90 degrees)</b>	<b>2pcs</b>
D		<b>4 Way Corner Connector (Model 1-180 degrees)</b>	<b>4pcs</b>
E		<b>3 Way Corner Connector (Model 1-180 degrees)</b>	<b>8pcs</b>

# ASSEMBLY INSTRUCTION

**IMPORTANT:** Ensure all parts are included prior to beginning assembly. Use basic tools if necessary to ensure the steel frame is fully assembled.

**Step 1: Assemble the top frame using the connectors and tubes shown below.**

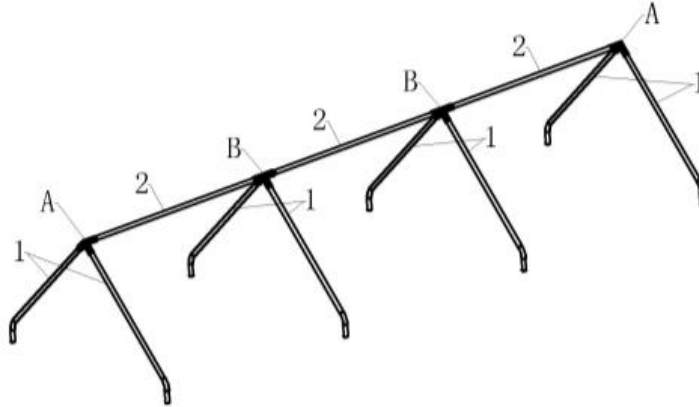

**Step 2: Assemble the floor frame using the connectors and tubes shown below.**

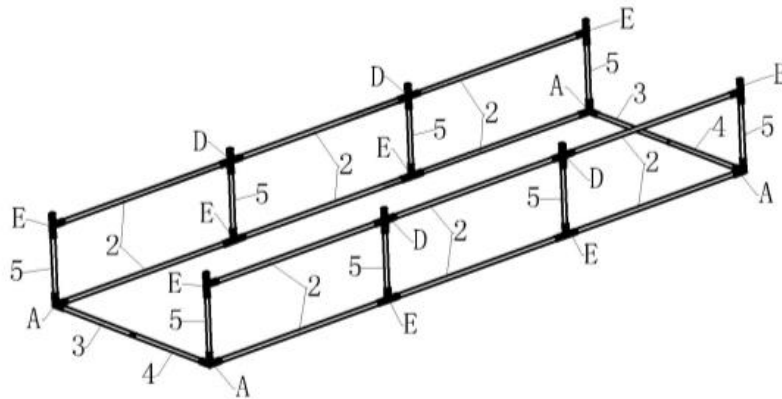

**Step 3: Install the top frame to the floor frame.**

**Step 4: Put cover**

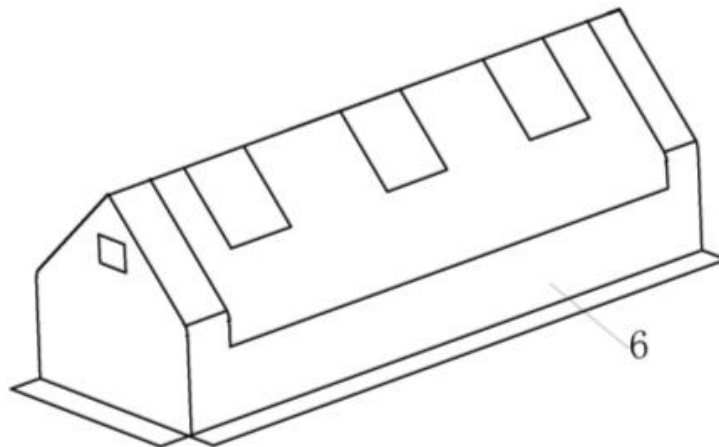

# EXPLODED VIEW

