

Multi-Use Hitch for ZTR and Garden Tractors

NEED HELP? Please call our customer service line before returning to the store. 1-877- 575-3173. TheMojack.com

Parts List

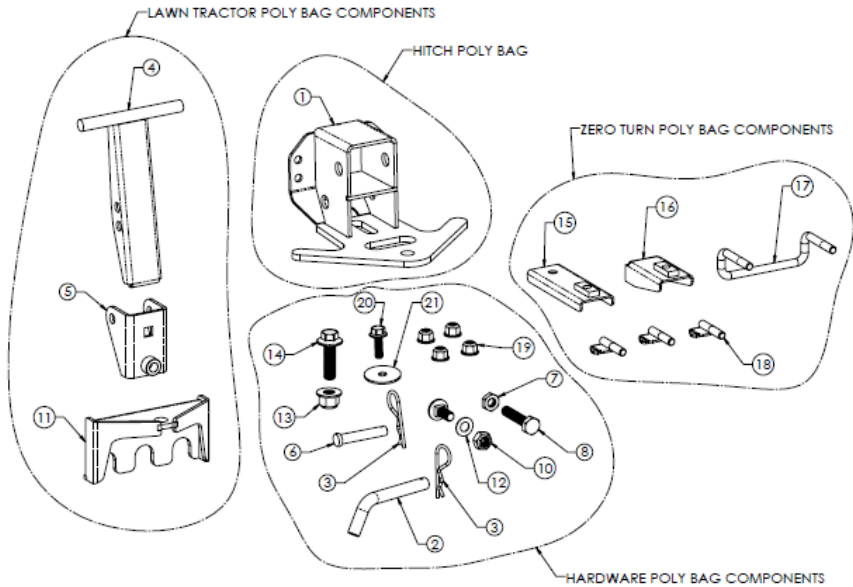

ITEM NO.	QTY.	DESCRIPTION
1	1	WLD. MULTI-HITCH - 701-0002
2	1	PIN, HITCH
3	2	PIN, HAIR
4	1	WLD. REACTION BAR - 701-0015
5	1	WLD. PIVOT BRACKET - 701-0013
6	1	PIN, CLEVIS
7	1	NUT, JAM M8 X 50
8	1	SCREW, HHCS M8 X 50
9	1	SCREW, CARRAIGE M10 X 25
10	1	NUT, NI M10
11	1	WLD. HITCH SUPPORT - 701-0008
12	1	WASHER, FLAT M10
13	1	NUT, FLHNI M12
14	1	SCREW, FLHCS M12 X 40
15	1	WLD. LONG SUPPORT CHANNEL
16	1	WLD. SHORT SUPPORT CHANNEL
17	1	U-BOLT
18	3	WLD. J BOLT
19	4	NUT, FLHNI M8
20	1	SCREW, FLHCS M8 X 25
21	1	WASHER, FLAT M8 X 38

This hitch system is designed to fit on many different brands of mowers. Please see the Lawn Tractor and ZTR Hitch Assembly instructions (back) and style diagram to find your specific ZTR bumper style

ZTR hitch assembly may be slightly different based on one of these 4 ZTR bumper styles. Please visit the site link below to get hitch assembly instructions for the specific ZTR brand <http://www.themojack.com/products/accessories/hitch-multi-use-hitch.html>

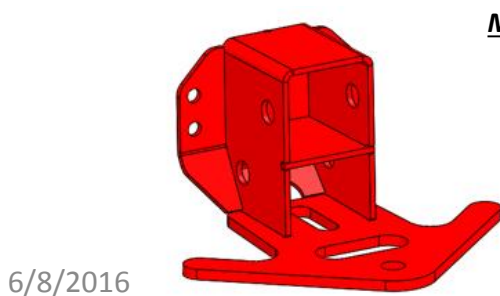
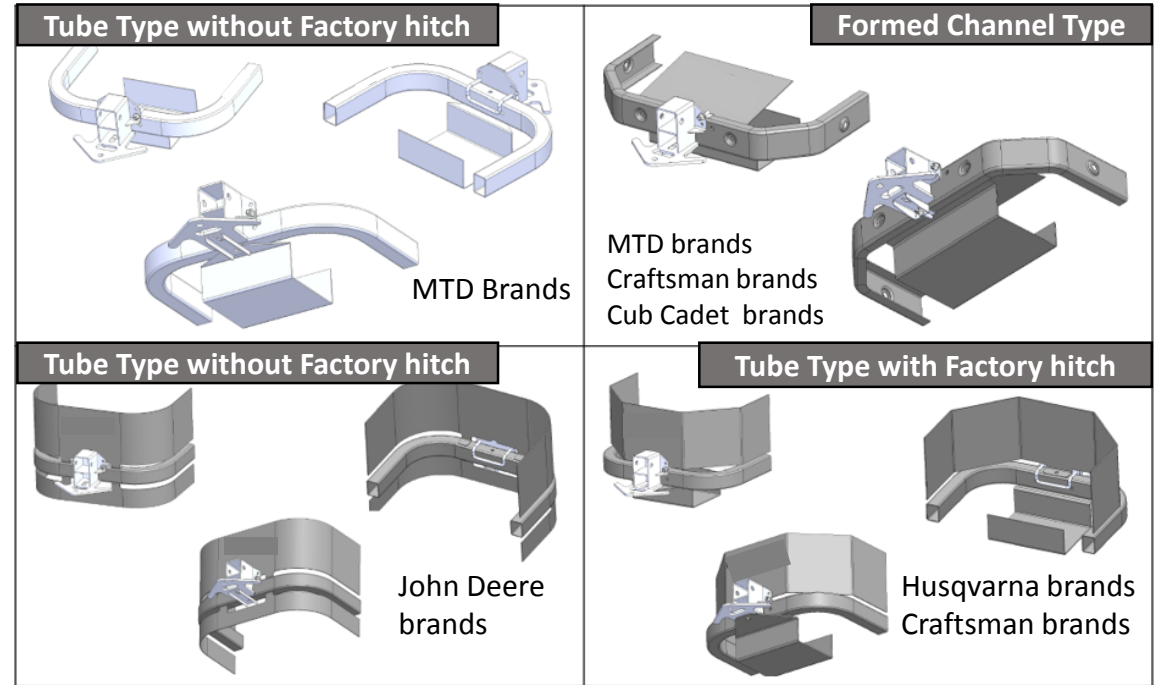

Multi-Use Hitch

Basic Lawn Tractor bumper style

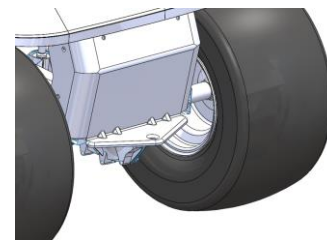

ZTR bumper styles

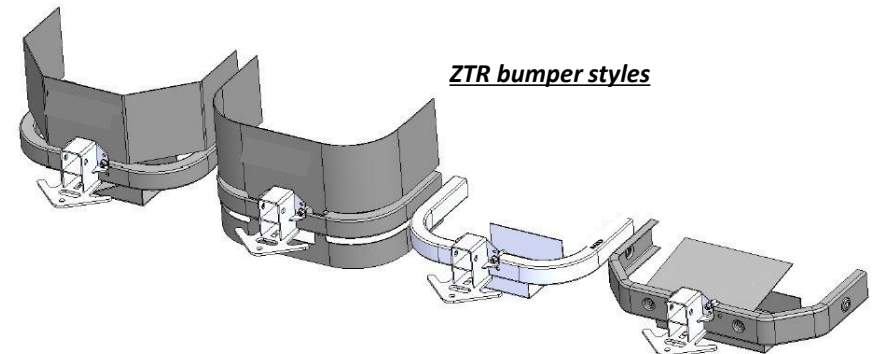

Lawn Tractor Hitch Assembly

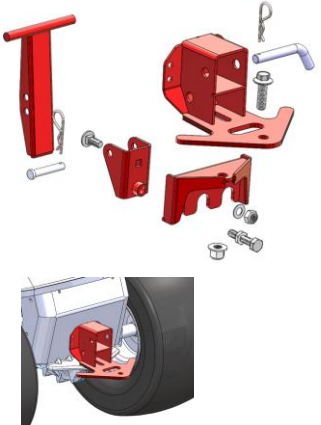
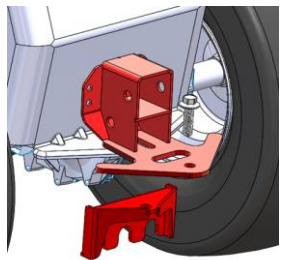
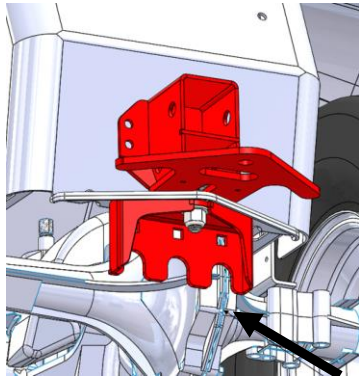
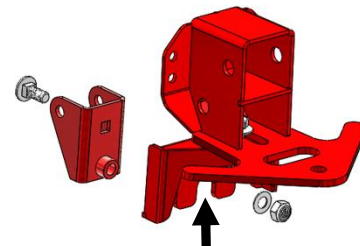
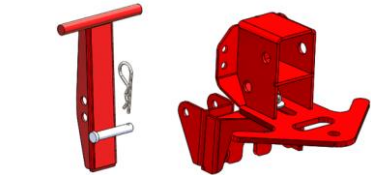
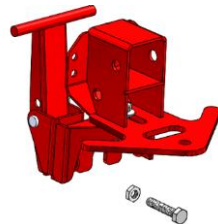
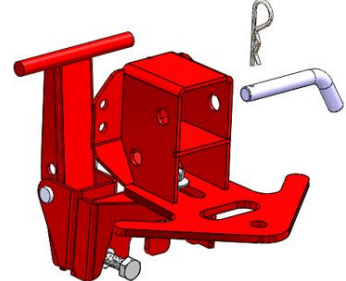
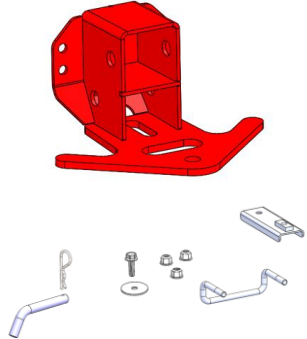
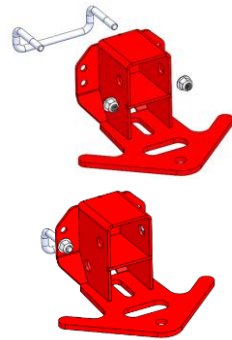
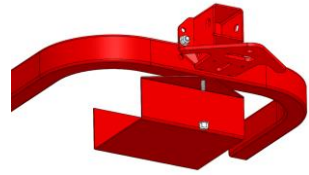
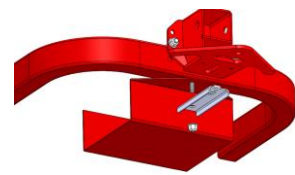
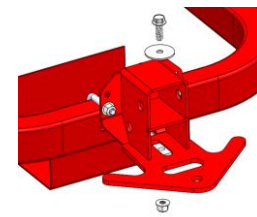
 <p>Install 701-0002 Multi Hitch Weldment on top of tractor hitch plate</p>	<p>Install 701-0008 Hitch Support Weldment under tractor hitch plate - Secure using (1) 003-0063 M12 x 40mm screw and (1) 002-0002 M12 Nut</p> 	 <p>Determine which side of the mower the transmission main housing is located on</p>	<p>Using (1) 003-0062 M10 x 25 Carriage Screw and (1) 002-0001 M10 Nut, install 701-0013 Pivot Bracket Weldment on the opposite side of the tractor from the transmission main housing</p>  <p>If possible mount Pivot bracket in center position</p>	<p>Install 701-0015 Reaction Bar Weldment into Pivot Bracket using (1) 001-0059 Clevis Pin and (1) 001-0010 Hair Pin</p>  <p>Install (1) 003-0078 M8 x 50mm Screw and (1) 002-0041 M8 Jam Nut into welded nut on Hitch Support Weldment</p> 	 <p>Top of reaction bar applies pressure here</p> <p>Tighten 003-0061 M10 Screw so that top of Reaction Bar applies pressure to inside of tractor frame and tighten Jam Nut</p>
<p>ZTR Hitch Assembly <i>Tube Type without Factory hitch mount</i></p> 	<p>Loosely install (2) M8 Lock Nut on to U-Bolt</p> 	<p>Temporarily remove existing nut</p> 	<p>Install 711-0006 Long Support Bracket and secure using existing nut</p> 	<p>Using (1) 003-0075 M8 X 25, (1) M8 Flat Washer and (1) M8 Lock Nut, attach 711-0006 Long Support Channel to bottom of hitch. Tighten all hardware.</p> 	<p>Install Hitch Pin and Hair Pin</p> 