

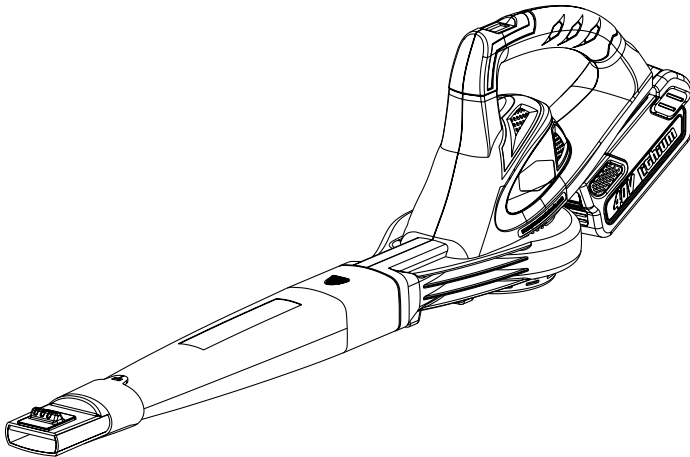

greenworks™

40V LITHIUM-ION CORDLESS BLOWER

24282



Some Greenworks Lithium-Ion products are sold with or without battery and charger.



To order: Battery (Sold Separately)
(2Ah Model # 29462 / 4Ah Model # 29472)

Charger (Sold Separately) (Model # 29482)

Owner's Manual

TOLL-FREE HELPLINE: 1-888-90WORKS (888.909.6757)

www.GreenWorksTools.com

 Read all safety rules and instructions carefully before operating this tool.

CONTENTS

Contents	2
Product specifications.....	2
General safety rules	3-5
Symbols.....	6-7
Know your blower	8
Assembly instruction.....	9-10
Operation.....	11
Maintenance.....	12
Environmentally safe battery disposal.....	13
Troubleshooting.....	14
Warranty.....	15
Exploded View	16
Parts List.....	17
Notes.....	18-19

PRODUCT SPECIFICATIONS

40V LITHIUM-ION CORDLESS BLOWER

Type	Cordless, battery-operated
Motor	40 V
Air volume.....	135 CFM
Air speed (Max).....	150 MPH
Weight (without battery)	3.39 lbs



GENERAL SAFETY RULES

WARNING

Read and understand all instructions before using this product. Failure to follow all instructions listed below may result in electric shock, fire, and/or serious personal injury.

- Do not operate power tools in explosive atmospheres, such as in the presence of flammable liquids, gases, or dust. Power tools create sparks which may ignite the dust or fumes.
- Do not allow children or untrained individuals to use this unit.
- Don't expose power tools to rain or wet conditions. Water entering a power tool will increase the risk of electric shock.
- Do not handle plug or tool with wet hands.
- Never allow children to operate the equipment. Never allow adults to operate the equipment without proper instruction.
- Always wear safety glasses with side shields that comply with ANSI Z87.1. Everyday glasses have only impact resistant lenses. They are NOT safety glasses. Following this rule will reduce the risk of eye injury. Use face mask if operation is dusty.
- Wear eye protection when operating this product. Secure long hair above shoulder level to prevent entanglement in moving parts.
- Use extra care when cleaning on stairs.
- Do not expose to rain, store indoors.
- Do not operate in poor lighting.
- Keep all parts of your body away from any moving part.
- Keep hair, loose clothing, fingers and all body parts away from openings and moving parts.
- Wear heavy long pants, boots, and gloves. Avoid loose garments and jewelry that could get caught in moving parts of the machine or its motor.
- Do not force tool. Use the correct tool for your application. The correct tool will do the job better and safer at the rate for which it is designed.
- Do not operate the equipment while barefoot or when wearing sandals or similar lightweight footwear. Wear protective footwear that will protect your feet and improve your footing on slippery surfaces.
- Secure long hair so it is above shoulder level to prevent entanglement in any moving parts.
- Keep firm footing and balance. Do not overreach. Overreaching can result in loss of balance.
- Do not allow to be used as a toy. Close attention is necessary when used by or near children.
- Do not use tool if switch does not turn it on or off. Any tool that cannot be controlled with the switch is dangerous and must be repaired.
- Keep all bystanders, children, and pets at least 50 ft. away.
- Do not operate this unit when you are tired, ill, or under the influence of alcohol, drugs, or medication.
- Do not operate in poor lighting.

GENERAL SAFETY RULES

- Keep all parts of your body away from any moving parts and all hot surfaces of the unit.
- Do not put any object into openings. Do not use with any opening blocked; keep openings free of dust, lint, hair, and anything that may reduce air flow.
- Check the work area before each use. Remove all objects such as rocks, broken glass, nails, wire, or string which can be thrown or become entangled in the machine.
- Use only identical manufacturer's replacement parts and accessories. Use of any other parts may create a hazard or cause product damage.
- Do not charge battery tool in rain, or damp or wet location. Following this rule will reduce the risk of electric shock.
- For household use only.
- Battery tools do not have to be plugged into an electrical outlet; therefore, they are always in operating condition. Be aware of possible hazards when not using your battery tool or when changing accessories. Following this rule will reduce the risk of electric shock, fire, or serious personal injury.
- Remove or disconnect battery before servicing, cleaning or removing material from the gardening appliance.
- Use only Greenworks batteries (Model #29462 or 29472.)
- Store idle appliances - When not in use, blower should be stored indoors in a dry, locked place out of the reach of children.
- Do not dispose of the batteries in a fire. The cell may explode. Check with local codes for possible special disposal instructions.
- Do not open or mutilate the batteries. Released electrolyte is corrosive and may cause damage to the eyes or skin. It may be toxic if swallowed.
- Do not place battery tools or their batteries near fire or heat. This will reduce the risk of explosion and possibly injury.
- Batteries can explode in the presence of a source of ignition, such as a pilot light. To reduce the risk of serious personal injury, never use any cordless product in the presence of open flame. An exploded battery can propel debris and chemicals. If exposed, flush with water immediately.
- Do not crush, drop or damage battery pack. Do not use a battery pack or charger that has been dropped or received a sharp blow. A damaged battery is subject to explosion. Properly dispose of a dropped or damaged battery immediately.
- Exercise care in handling batteries in order not to short the battery with conducting materials such as rings, bracelets, and keys. The battery or conductor may overheat and cause burns. Do not open or mutilate the batteries. Released electrolyte is corrosive and may cause damage to the eyes or skin. It may be toxic if swallowed.
- For best results, your battery tool should be charged in a location where the temperature is more than 50°F but less than 100°F. To reduce the risk of serious personal injury, do not store outside or in vehicles.
- Under extreme usage or temperature conditions, battery leakage may occur. If liquid comes in contact with your skin, wash immediately with soap and water, then neutralize with lemon juice or vinegar. If liquid gets into your eyes, flush them with clean water for at least 10 minutes, then seek immediate medical attention. Following this rule will reduce the risk of serious personal injury.

GENERAL SAFETY RULES

- If the power supply cord is damaged, it must be replaced only by the manufacturer or by an authorized service center to avoid risk.
- Do not point the blower nozzle in the direction of people or pets.
- Never run the unit without the proper equipment attached. Always ensure the sweeper tubes are installed.
- When not in use, blower should be stored indoors in a dry, locked up place—out of the reach of children.
- Maintain tool with care. Keep fan area clean for best and safest performance. Follow instructions for proper maintenance. Do not attempt to clear clogs from tool without first removing the battery.
- To reduce the risk of electrical shock, do not expose to rain, do not use on wet surfaces. Store indoors.
- Save these instructions. Refer to them frequently and use them to instruct others who may use this power tool. If you loan someone this power tool, loan them these instructions also.

CHILD SAFETY

Tragic accidents can occur if the operator is not aware of the presence of children.

- Keep children out of the working area and under the watchful care of a responsible adult.
- Do not allow children under the age of 14 to operate this blower. Children who are 14 years of age and older must read and understand the operating instructions and safety rules in this manual and must be trained and supervised by a parent.
- Stay alert, and turn the blower off if a child or any other person enters the working area.
- Use extreme care when approaching blind corners, doorways, shrubs, trees, or other objects that may obscure your view of a child who may run into the path of the blower.

W A R N I N G (PROPOSITION 65)









Some dust created by power sanding, sawing, grinding, drilling, and other construction activities contains chemicals known to cause cancer, birth defects or other reproductive harm. Some examples of these chemicals are:

- Lead from lead-based paints
- Crystalline silica from bricks and cement and other masonry products, and
- Arsenic and chromium from chemically treated lumber.

Your risk of exposure to these chemicals varies depending on how often you do this type of work. To reduce your exposure to these chemicals, work in a well-ventilated area, and work with approved safety equipment, such as dust masks that are specially designed to filter out microscopic particles.



SYMBOLS

Some of the following symbols may be used on this product. Please study them and learn their meaning. Proper interpretation of these symbols will allow you to operate the product better and safer.

SYMBOL	NAME	DESIGNATION/EXPLANATION
V	Volts	Voltage
A	Amperes	Current
Hz	Hertz	Frequency (cycles per second)
W	Watts	Power
min	Minutes	Time
~	Alternating Current	Type of current
—	Direct Current	Type or a characteristic of current
	No Load Speed	Rational speed, at no load
/min	Per Minute	Revolutions, strokes, surface speed, orbits etc., per minute
	Wet Conditions Alert	Do not expose to rain or use in damp locations
	Read The Operator's Manual	To reduce the risk of injury user must read and understand operator's manual before using this product.
	Eye Protection	Wear eye protection that is marked to comply with ANSI Z87.1 when operating this equipment.
	Safety Alert	Precautions that involve your safety.
	Long Hair	Failure to keep long hair away from the air inlet could result in personal injury.
	Loose Clothing	Failure to keep loose clothing from being drawn into air intake could result in personal injury.
	Keep Bystanders Away	Keep all bystanders at least 50 ft. away.
	Blower Tubes	Do not operate without tubes in place.

SYMBOLS

The following signal words and meanings are intended to explain the levels of risk associated with this product.

SYMBOL	SIGNAL	MEANING
	DANGER	Indicates an imminently hazardous situation, which, if not avoided, will result in death or serious injury.
	WARNING	Indicates a potentially hazardous situation, which, if not avoided, could result in death or serious injury.
	CAUTION	Indicates a potentially hazardous situation, which, if not avoided, may result in minor or moderate injury.
	CAUTION	(Without Safety Alert Symbol) Indicates a situation that may result in property damage.

SERVICE

Servicing requires extreme care and knowledge and should be performed only by a qualified service technician. For service we suggest you return the product to your nearest **AUTHORIZED SERVICE CENTER** for repair. When servicing, use only identical replacement parts.

WARNING

To avoid serious personal injury, do not attempt to use this product until you have read this Owner's Manual thoroughly and understand it completely. If you do not understand the warnings and instructions in this Owner's Manual, do not use this product. Call the Toll-free Helpline (1-888-909-6757) for assistance. The operation of any power tool can result in foreign objects being thrown into your eyes, which can result in severe eye damage. Before operating a power tool, always wear safety goggles, safety glasses with side shields, or a full face shield when needed. We recommend a Wide Vision Safety Mask for use over eyeglasses or standard safety glasses with side shields. Always use eye protection that is marked to comply with ANSI Z87.1.

WARNING



The operation of any power tool can result in foreign objects being thrown into your eyes, which can result in severe eye damage. Before beginning power tool operation, always wear safety goggles or safety glasses with side shields and, when needed, a full face shield. We recommend Wide Vision Safety Mask for use over eyeglasses or standard safety glasses with side shields. Always use eye protection which is marked to comply with ANSI Z87.1.

SAVE THESE INSTRUCTIONS

KNOW YOUR BLOWER

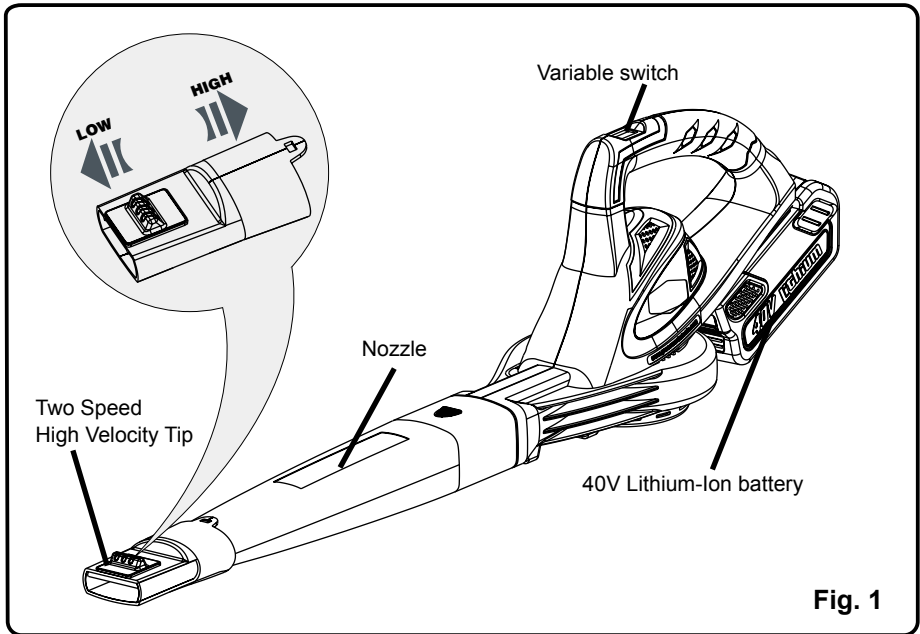

Fig. 1

KNOW YOUR BLOWER (See Figure 1.)

The safe use of this product requires an understanding of the information on the product and in this operator's manual as well as a knowledge of the project you are attempting. Before use of this product, familiarize yourself with all operating features and safety rules.

BLOWER TUBE

The blower tube can be easily installed on the blower without any additional tools.

ASSEMBLY INSTRUCTION

BATTERY

IMPORTANT! The battery pack is not charged when it is purchased. Before using the trimmer for the first time, place the battery pack in the battery charger and charge. Make sure to read all safety precautions, and follow the instructions in the Battery Charger section.

To remove (See Figure 2.)

1. Press the latch button (1) on the battery pack down and hold.
2. Grasp the blower (2) firmly, and pull the battery pack out of the handle.

NOTE: The battery pack fits into the handle snugly in order to prevent accidental dislodging. It may require a strong pull to remove it.

To install (See Figure 2.)

1. Align the tongue (3) of the battery pack with the cavity in the blower housing.
2. Grasp the blower (2) firmly.
3. Push the battery pack into the handle until the latch locks into place.
4. Do not use force when inserting the battery pack. It should slide into position and “click”.

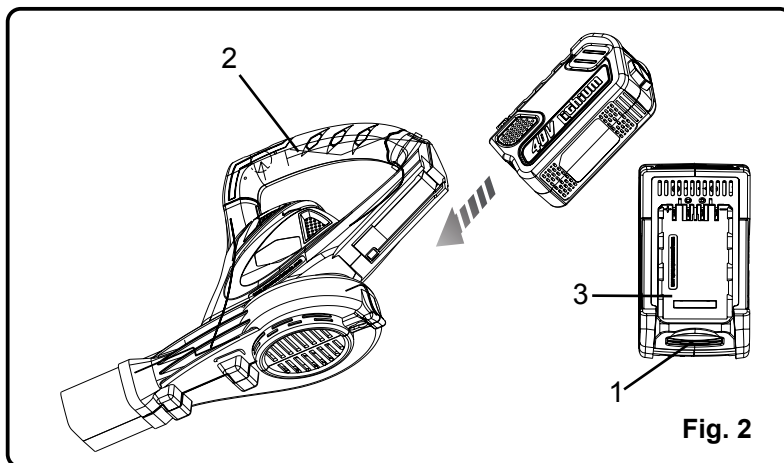

Fig. 2

⚠ WARNING

Follow these instructions in order to avoid injury and to reduce the risk of electric shock or fire:

- Replace the battery pack or the charger immediately if the battery case or charger cord is damaged.
 - Verify that the switch is in the OFF position before inserting or removing the battery pack.
 - Verify that the battery pack is removed and the switch is in the OFF position before inspecting, adjusting, or performing maintenance on any part of the blower.
 - Read, understand, and follow the instructions contained in the section entitled Charging Procedure.
-

ASSEMBLY INSTRUCTION

Nozzles (See Figure 3.)

The two nozzles extend the reach of the blower.

For blowing (See Figure 3.):

1. Align the widest end of the large nozzle (1) with the front opening on the blower (2).
2. Slide the nozzle over the blower outlet opening until the latch on the blower is inserted into the opening on the nozzle.
3. Slide the smaller tapered nozzle (3) over the large nozzle until the latch on the large nozzle is inserted into the end of the opening on the small nozzle and locks into position.

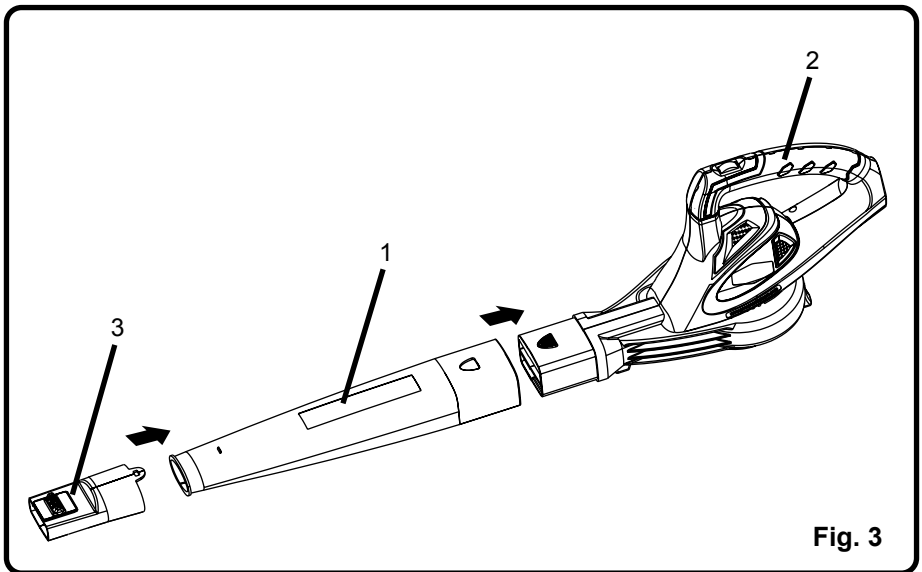

Fig. 3

OPERATION

STARTING/STOPPING THE BLOWER (See Figure 4.)

The blower is equipped with a Variable switch.

1. Install the battery pack. (Refer to **Installing the battery pack**)
2. Roll the speed dial forward (A) until a positive click is heard and the blower turns ON.
3. Rotate the dial forward to increase speed up to 150 MPH.
4. To turn off: Rotate the dial backwards (B) until unit shuts off.

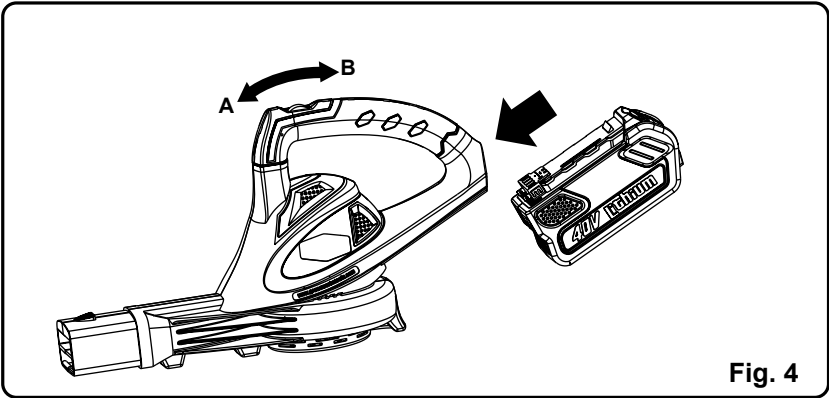

Fig. 4

Use the blower to (See Figure 5.) :

- Blow debris or grass clippings off of driveways, sidewalks, patios, parks, parking lots, etc.
- Gather grass clippings, straw, or leaves into piles.
- Remove debris from corners, around joints, and between bricks.

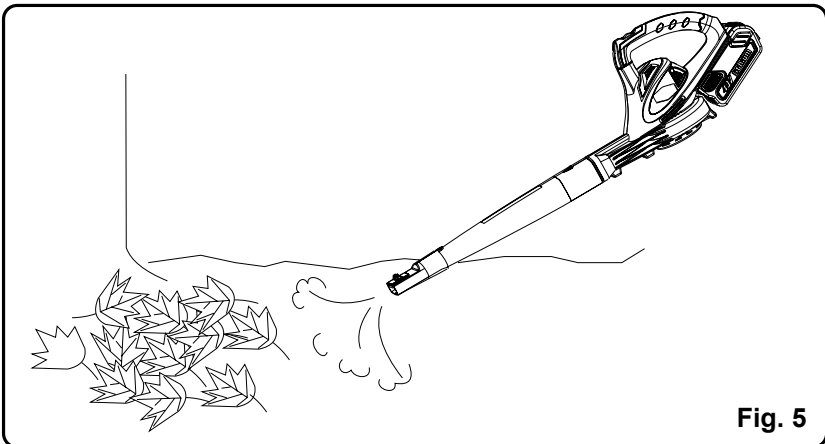

Fig. 5

MAINTENANCE

WARNING

In order to avoid personal injury and the risk of fire and electric shock, remove the battery pack before adjusting, inspecting, or cleaning the blower.

Cleaning

Remove the battery pack.

1. Brush or blow dust and debris out of the air vents using compressed air or a vacuum. Keep the air vents free of obstructions, sawdust, and wood chips. Do not spray, wash, or immerse the air vents in water.
2. Wipe off the housing and the plastic components using a moist, soft cloth. Do not use strong solvents or detergents on the plastic housing or plastic components. Certain household cleaners may cause damage, and may cause a shock hazard.

Battery Pack

- Store the battery pack fully charged.
- Once the charging light turns green, remove the battery from the charger and disconnect the charger from the outlet.
- Do not store the battery pack on the tool.
- After charging, the battery pack may be stored in the charger, as long as the charger is not plugged in.

Charger Maintenance

- Keep the charger clean and clear of debris. Do not allow foreign material to get into the recessed cavity or onto the contacts. Wipe the charger clean with a dry cloth. Do not use solvents or water, and do not place the charger in wet conditions.
- Unplug the charger when there is no battery pack in it.
- Fully charge the batteries before placing them in storage.
- Store the charger at normal room temperature. Do not store it in excessive heat. Do not use the charger in direct sunlight. Recharge at room temperature between 45°F and 104°F (7°C and 40°C). If the battery pack is hot, allow it to cool down before recharging.

ENVIRONMENTALLY SAFE BATTERY DISPOSAL



The following toxic and corrosive materials are in the batteries used in this blower battery pack: **Lithium-Ion, a toxic material.**

W A R N I N G

All toxic materials must be disposed of in a specified manner to prevent contamination of the environment. Before disposing of damaged or worn out Lithium-Ion battery packs, contact your local waste disposal agency, or the local Environmental Protection Agency for information and specific instructions. Take the batteries to a local recycling and/or disposal centre, certified for lithium-ion disposal.

W A R N I N G

If the battery pack cracks or breaks, with or without leaks, do not recharge it and do not use. Dispose of it and replace with a new battery pack. **DO NOT ATTEMPT TO REPAIR IT!** To avoid injury and risk of fire, explosion, or electric shock, and to avoid damage to the environment:

- Cover the battery's terminals with heavy-duty adhesive tape.
 - DO NOT attempt to remove or destroy any of the battery pack components.
 - DO NOT attempt to open the battery pack.
 - If a leak develops, the released electrolytes are corrosive and toxic. DO NOT get the solution in the eyes or on skin, and do not swallow it.
 - DO NOT place these batteries in your regular household trash.
 - DO NOT incinerate.
 - DO NOT place them where they will become part of any waste landfill or municipal solid waste stream.
 - Take them to a certified recycling or disposal centre.
-

TROUBLESHOOTING

PROBLEM	POSSIBLE CAUSE	SOLUTION
Motor fails to start when switch trigger is depressed.	Battery is not secure.	To secure the battery pack, make sure the latches on the top of the battery pack snap into place.
	Battery is not charged.	Charge the battery pack according to the instructions included with your model.
Unit will not start.	Defective power switch.	Return to place of purchase or return the unit to a repair center.
Unit will not blow.	Blocked tube.	Clear the blockage.

LIMITED FOUR-YEAR WARRANTY



GREENWORKS™ hereby warrants this product, to the original purchaser with **proof of purchase**, for a period of four (4) years against defects in materials, parts or workmanship. GREENWORKS™, at its own discretion will repair or replace any and all parts found to be defective, through normal use, free of charge to the customer. This warranty is valid only for units which have been used for personal use that have not been hired or rented for industrial/commercial use, and that have been maintained in accordance with the instructions in the owners' manual supplied with the product from new.

Battery and charger carry a two (2) year warranty against defects in workmanship and materials. Batteries must be charged in accordance with the operator's manuals directions and regulations in order to be valid.

ITEMS NOT COVERED BY WARRANTY:

1. Any part that has become inoperative due to misuse, commercial use, abuse, neglect, accident, improper maintenance, or alteration; or
2. The unit, if it has not been operated and/or maintained in accordance with the owner's manual; or
3. Normal wear, except as noted below;
4. Routine maintenance items such as lubricants, blade sharpening;
5. Normal deterioration of the exterior finish due to use or exposure.

GREENWORKS HELPLINE (1 888 90WORKS):

Warranty service is available by calling our toll-free helpline, 9am to 5pm EST. at **1-888-909-6757 (1-888-90WORKS)**.

TRANSPORTATION CHARGES:

Transportation charges for the movement of any power equipment unit or attachment are the responsibility of the purchaser. It is the purchaser's responsibility to pay transportation charges for any part submitted for replacement under this warranty unless such return is requested in writing by GREENWORKS.

EXPLODED VIEW

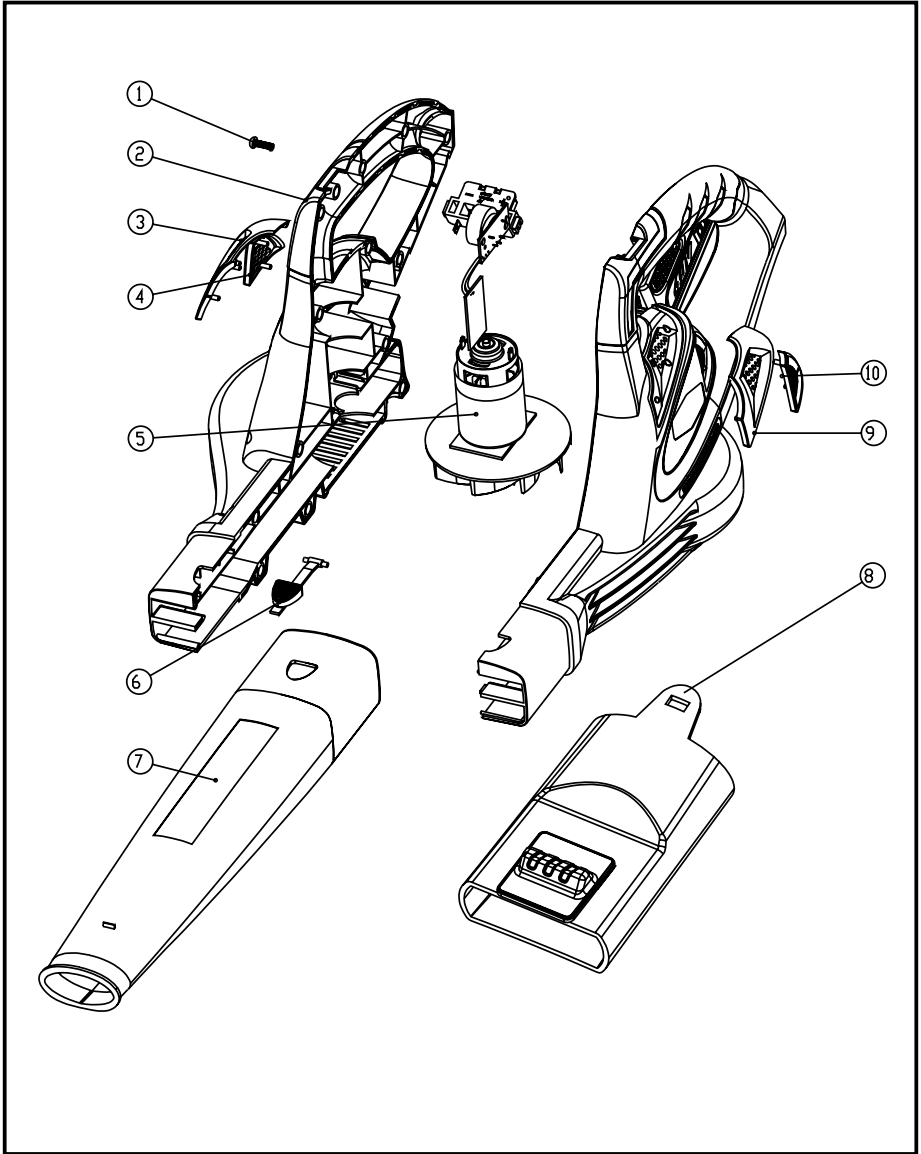

PARTS LIST

ITEM NO.	PART NO.	DESCRIPTION	QTY
1	32201459	Hex. Screw	13
2	31301213	Housing assembly	1
3	34103213	Right upper decoration	1
4	34104213	Right lower decoration	1
5	31103213	Motor and fan assembly	1
6	36302203-2	Blowing pipe button	1
7	34105213	Blowing pipe	1
8	31104213	Blowing tube	1
9	34101213	Left upper decoration	1
10	34102213	Left lower decoration	1



TOLL-FREE HELPLINE: 1-888-90WORKS (888.909.6757)

Rev: 00 (01-15-13)

 Printed in China on 100% Recycled Paper