

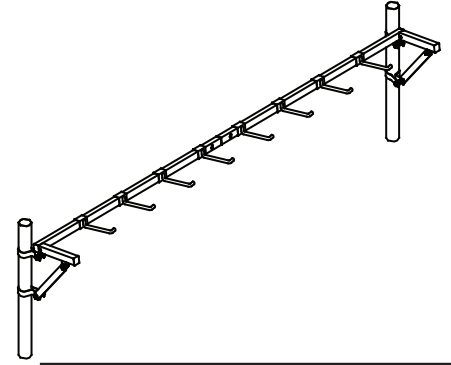











# Assembly Manual Parts List

## Tool Hanger-4' MDK

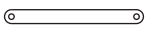
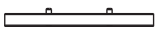
Model #14605  
English



Description of Parts	Qty.	Part #
 Clamp(1 3/8" Tube)	4	280
 Clamp (1 5/8" Tube)	4	802063
 Clamp (2" Tube)	4	279
 Clamp (2 3/8" Tube)	4	802064
	1	802527
	1	802528
 Hook	8	802529
 Inclined holding tube	2	802513
 Connect Tube	1	802504
 5/16" X 1 5/8" Bolt	4	802505
 5/16" X 1" Bolt	2	802506
 5/16" Nuts	6	00690
 5/16" Washer	6	802530

**Before You Start**

- 2 or more persons recommended to assemble
- Estimated assembly time = 0.5 hour

**Recommended Tools**

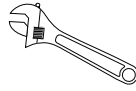
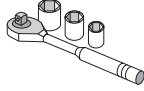
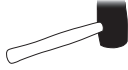
-  Adjustable wrench
- or
-  Ratchet with 1/2"
-  Rubber Mallet



800.524.9970  
www.shelterlogic.com

150 Callender Road  
Watertown, CT 06795

*Manufactured Under  
U.S. Patents  
D415,571 D409,310  
D430,306 D414,564  
Other Patents Pending*

Assembly Reference	Quantity of Parts	Mfg. Part #
1	4	clamp
2	1	802527
3	1	802528
4	8	802529
5	2	802513
6	1	802504
7	4	802505
8	2	802506
9	6	802530
10	6	00690

**For missing or replacement parts or questions,**

**Please contact:**

**Consumer Support**  
**1-800-524-9970**  
**Canada 1-800-559-6175**

# STEP 1

Fig. 1

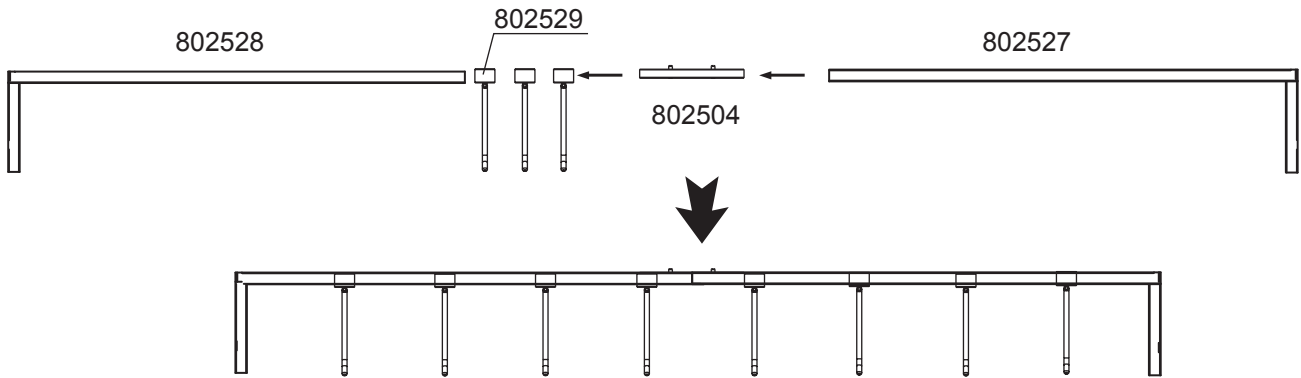

# STEP 2

Fig. 2

