

3-PIECE BISTRO SET

INSTRUCTION MANUAL

SKU #1045563

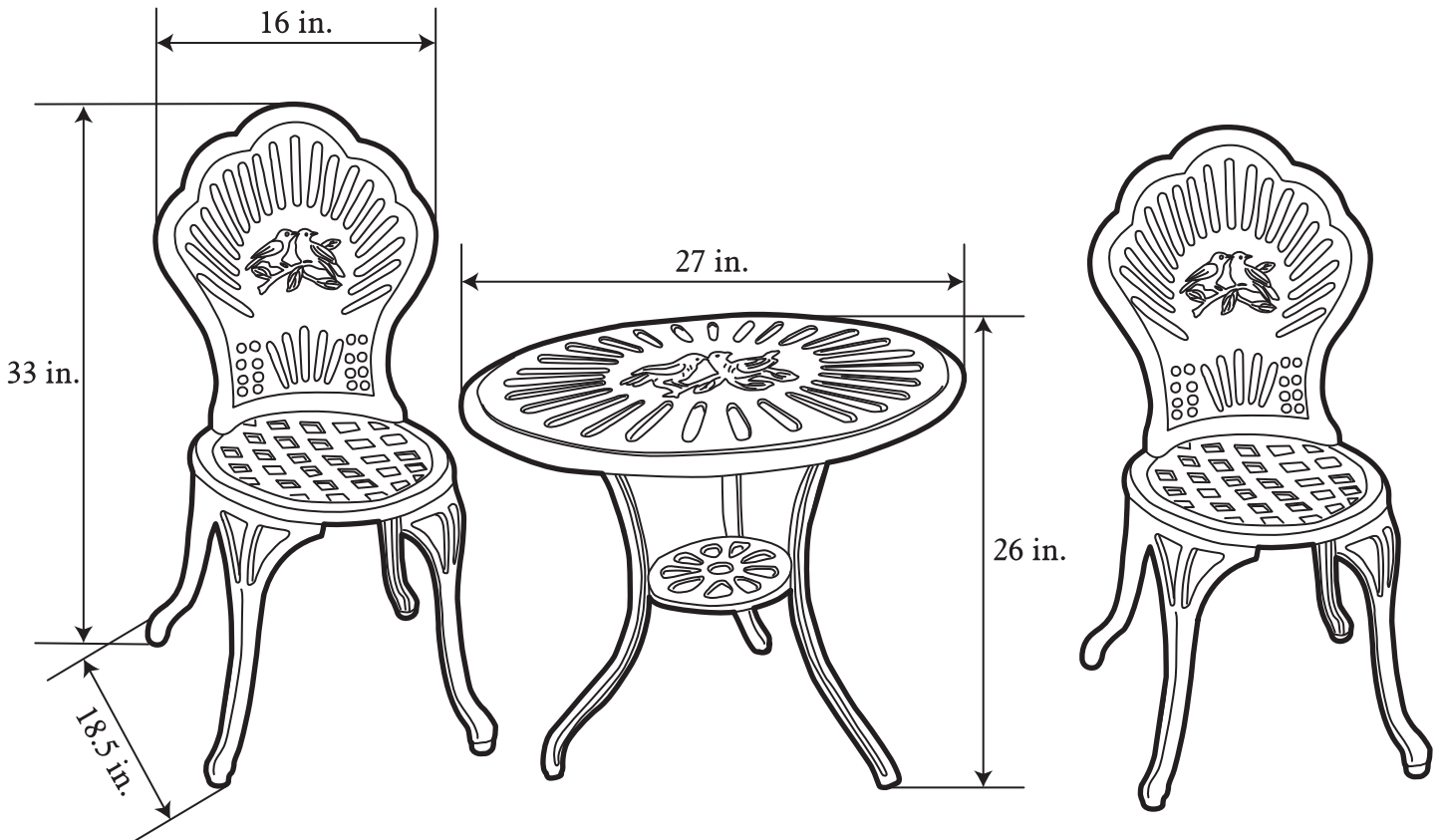

Assembled Dimensions

Distributed by:
TRACTOR SUPPLY COMPANY
200 POWELL PLACE
BRENTWOOD, TN 37027
For customer support,
call: 1-888-376-9601
www.TractorSupply.com

Approximate assembly time: **30 Minutes**

People for assembly:



Required assembly space:
Floor area 9 ft. x 9 ft. (3 m x 3 m)



Required assembly tools (Included):

Wrench



Hex key wrench



Caution: Hand tools only,
use of power tools could
damage product.

PARTS LIST

No.	Description	Quantity	No.	Description	Quantity
1	Table Top	1	4	Back	2
2	Table Leg	3	5	Seat	2
3	Connection	1	6	Leg	8

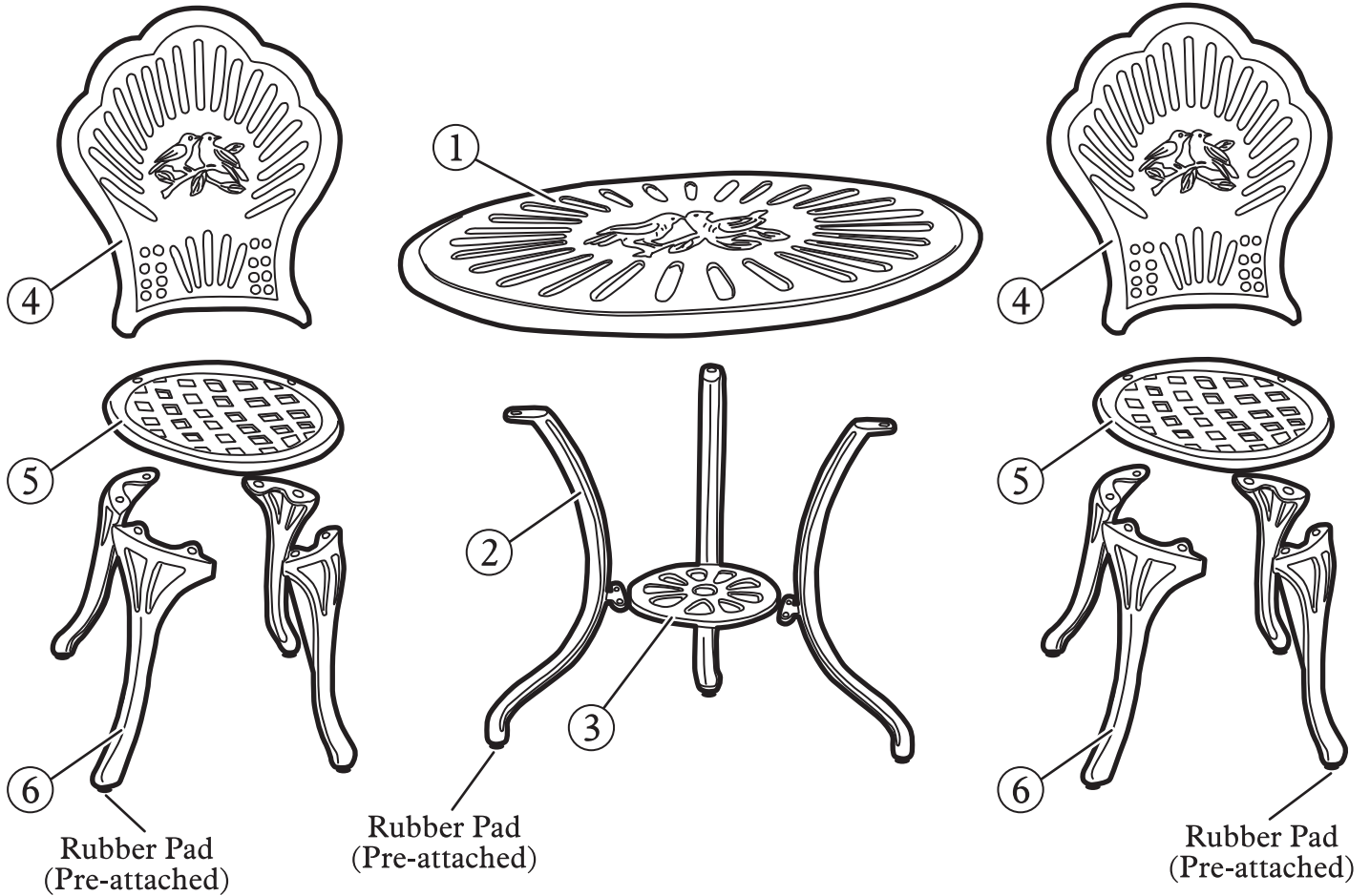

HARDWARE LISTS

Ⓐ 23 pcs



A3
Nut



A2
Washer



A1
Bolt

M8 x 30mm

Ⓑ 6 pcs



B4
Nut Cap



B3
Nut



B2
Washer

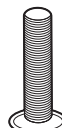

B1
Bolt

M6 x 30mm

TIPS BEFORE YOU START!

1. Ensure that all parts are present prior to assembly.
2. Check all packing material carefully before discarding, as some parts may be encased in the packing material.
3. For ease and speed assembly, it is recommended that prior to each step all required parts are identified.
4. Ensure that you have sufficient space and people (as indicated on page 1) to assemble product safely.
5. During assembly take care not to over-tighten any fittings, as this may damage the product.

CARE AND MAINTENANCE

- For domestic and outdoor use.
- Periodically check all fittings and re-tighten as necessary.
- Do not stand on chair or table.
- This product should only be used on firm, level ground.
- Adjust the rubber pad to make chair / table stable.

WEIGHT LIMIT

Chair: 500 lb. (226kg.)

TABLE ASSEMBLY INSTRUCTIONS

Step 1

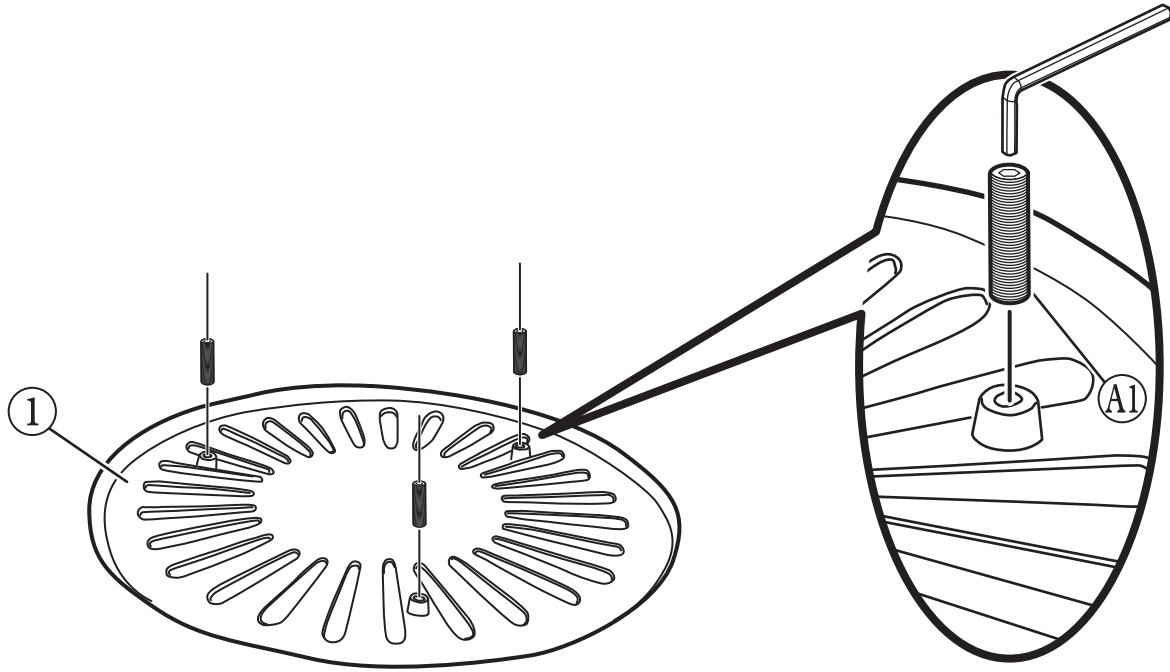

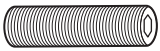

Ⓐ1 3 pcs - Bolt  M8 x 30mm

Hex key wrench

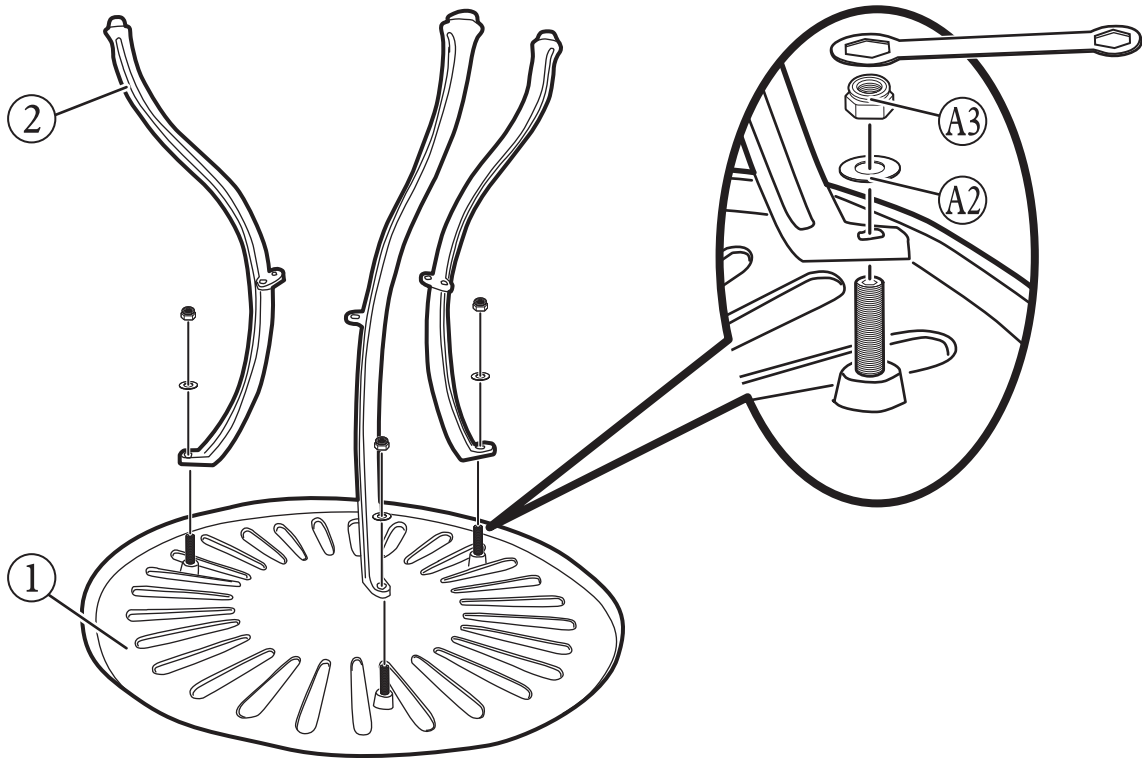

Step 2



Ⓐ2 3 pcs - Washer 

Ⓐ3 3 pcs - Nut 

Wrench



TABLE ASSEMBLY INSTRUCTIONS

Step 3

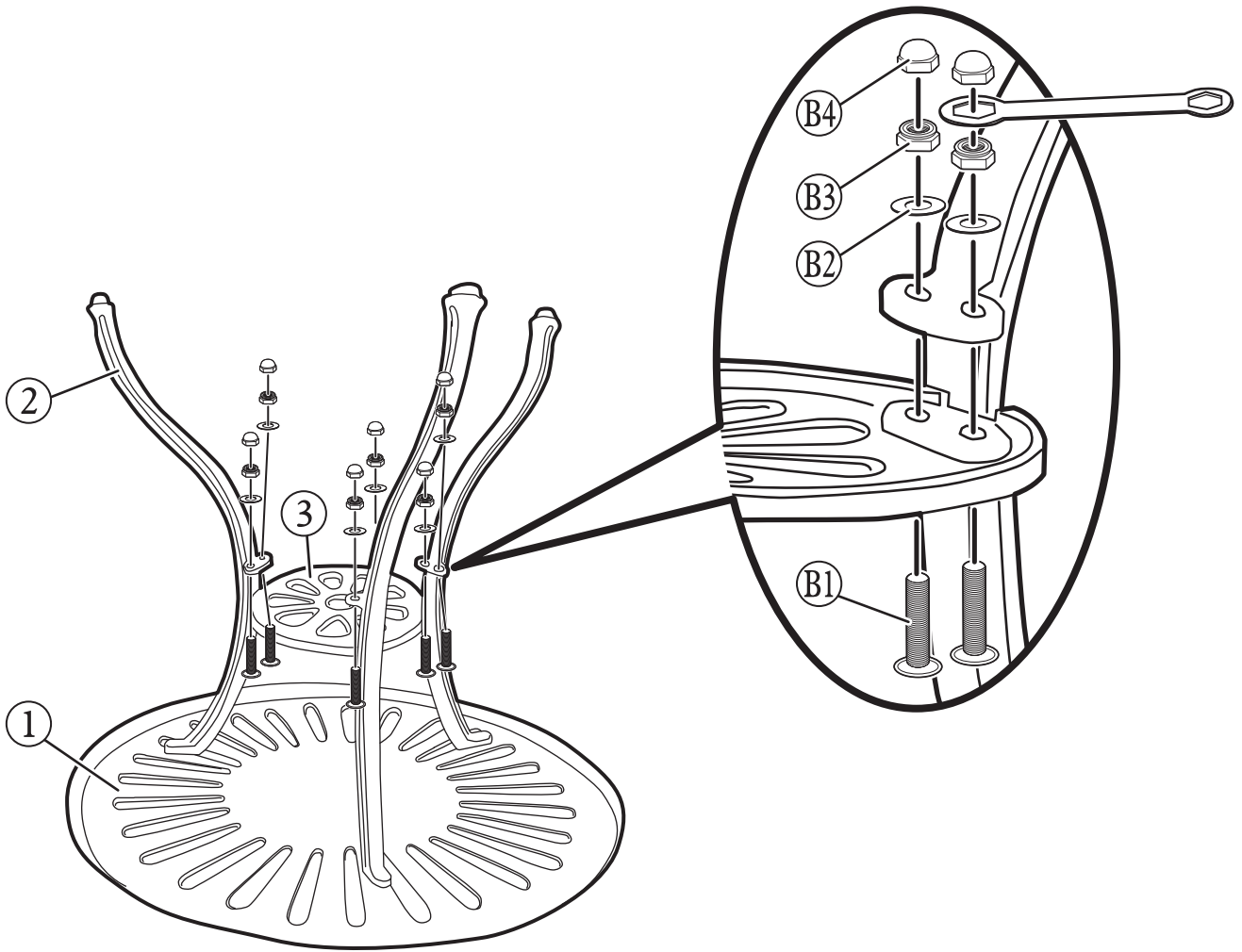

ⓑ1 6 pcs - Bolt  M6 x 30mm

ⓑ3 6 pcs - Nut 

ⓑ2 6 pcs - Washer 

ⓑ4 6 pcs - Nut Cap 

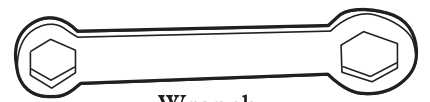

CHAIR ASSEMBLY INSTRUCTIONS

Step 1

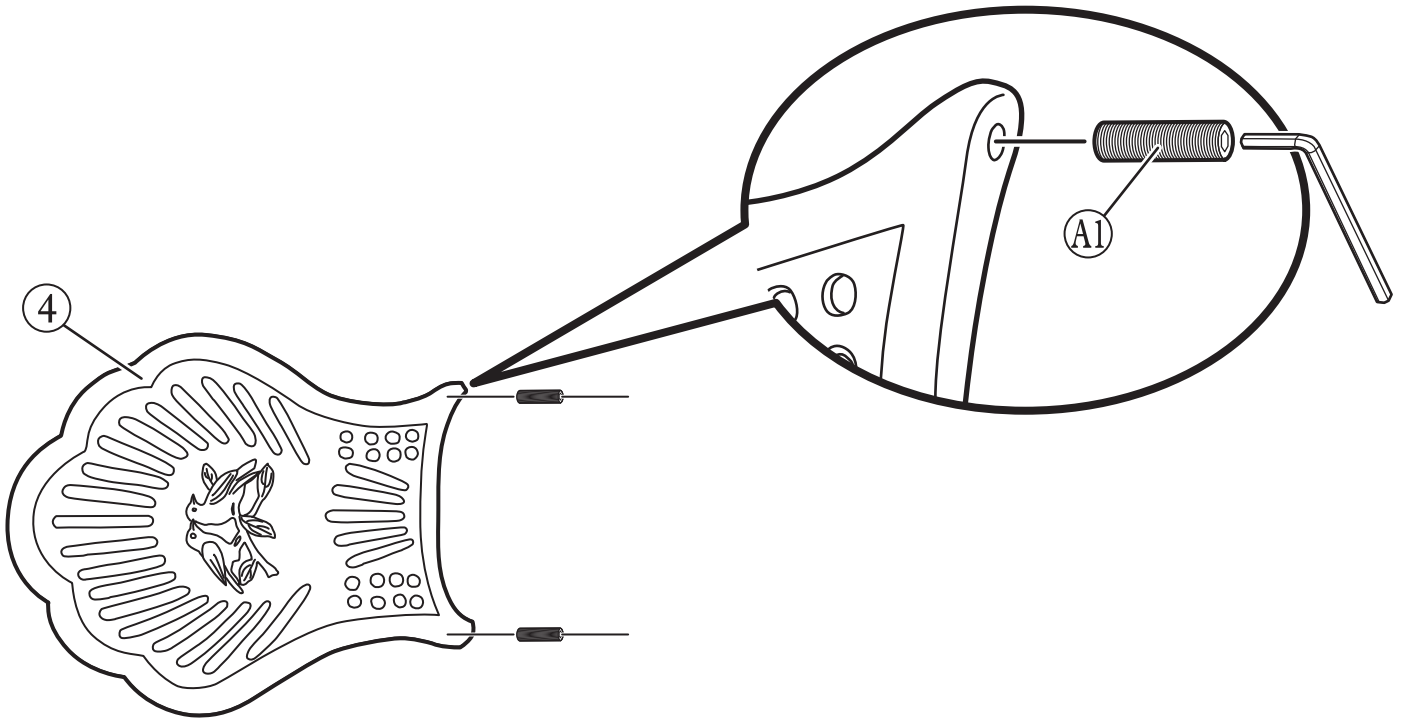

(A1) 2 pcs - Bolt

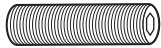

M8 x 30mm

Hex key wrench



Step 2

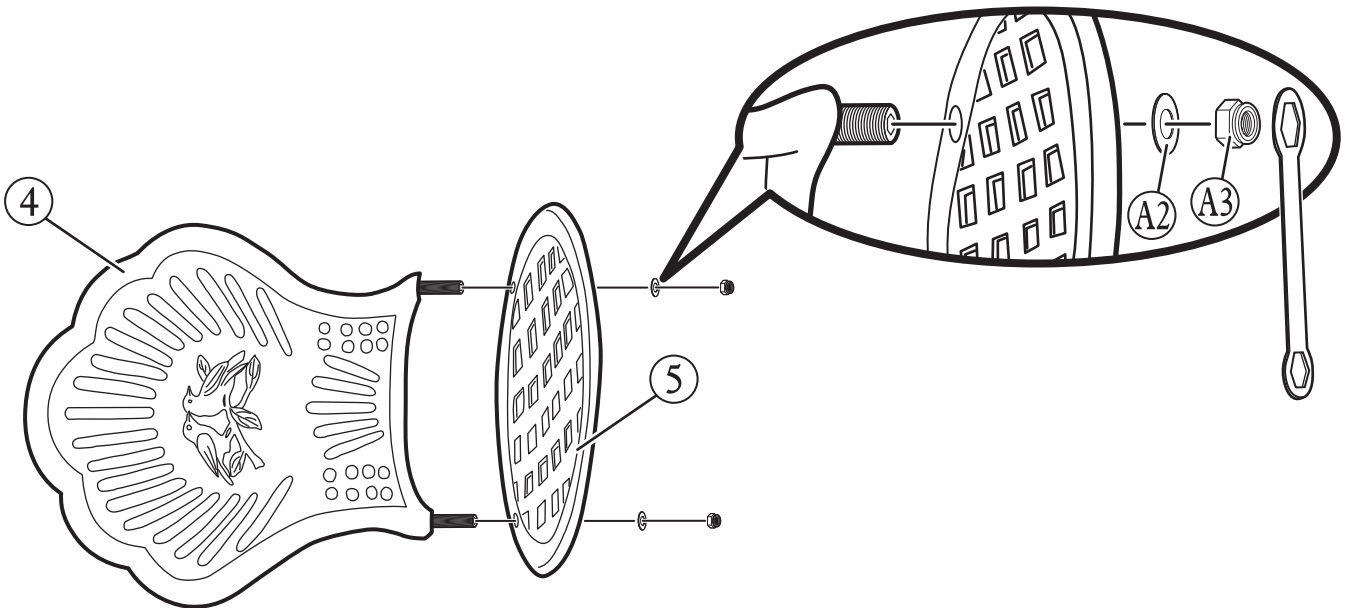

(A2) 2 pcs - Washer



(A3) 2 pcs - Nut



Wrench



CHAIR ASSEMBLY INSTRUCTIONS

Step 3

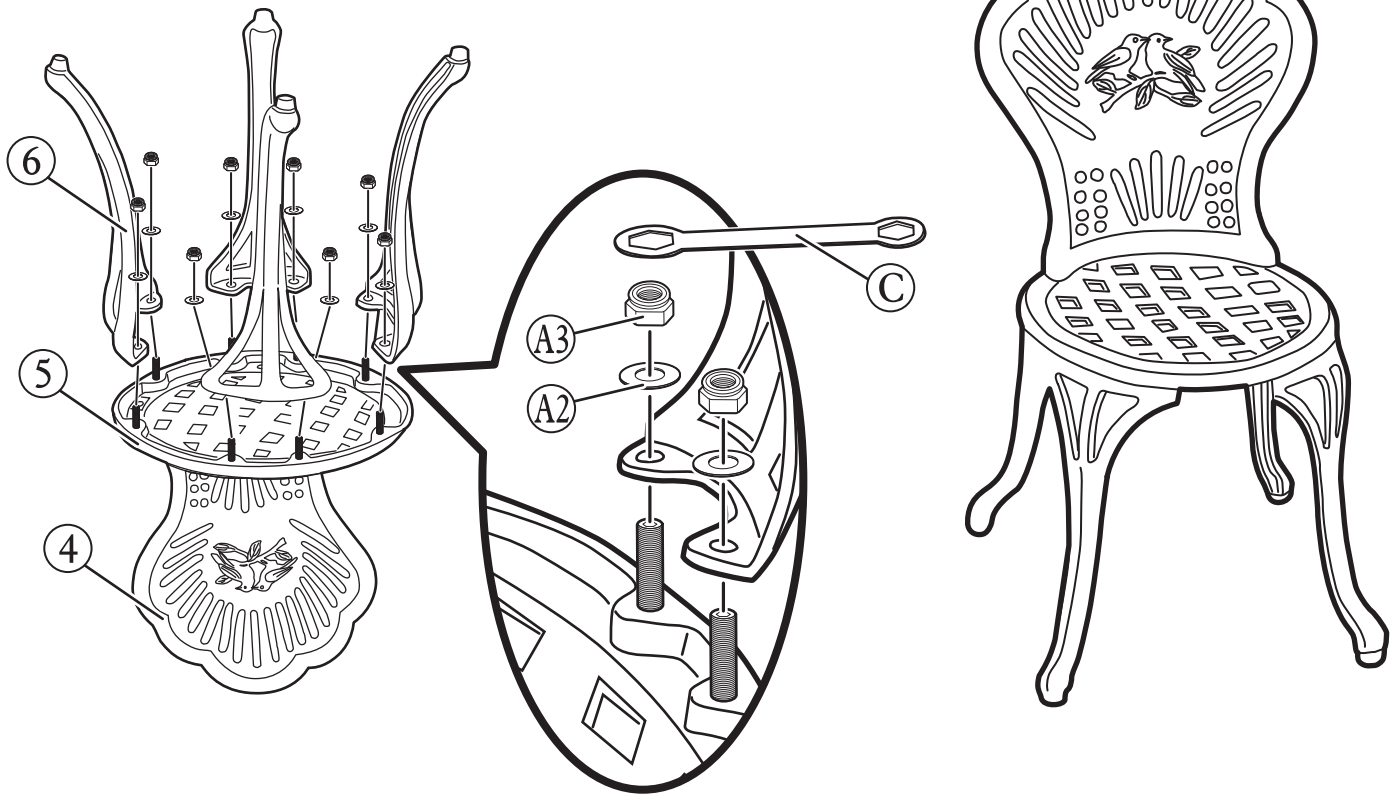
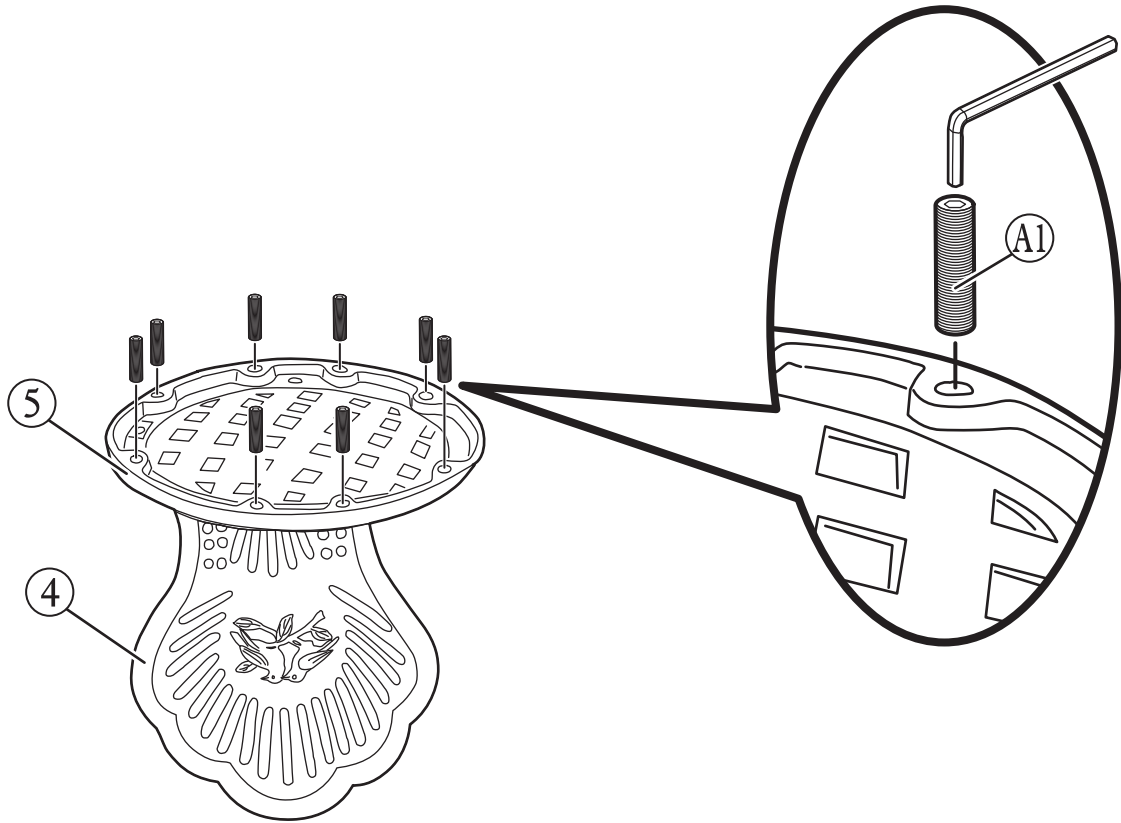

(A1) 8 pcs - Bolt

(A2) 8 pcs - Washer



(A3) 8 pcs - Nut



Wrench



Hex key wrench



M8 x 30mm